

# INFANTRY-BASED OPPOSING FORCE ORGANIZATION GUIDE

## TABLE OF CONTENTS

|                           |  |      |
|---------------------------|--|------|
| <b>Preface</b> .....      |  | iv   |
| <b>Introduction</b> ..... |  | v    |
| <b>Chapter 1</b>          | <b>Military Districts and Motorized Infantry Divisions</b> ..... | 1-1  |
|                           | Military District .....  | 1-3  |
|                           | Motorized Infantry Division .....                                | 1-5  |
| <b>Chapter 2</b>          | <b>Infantry and Mechanized Infantry Divisions</b> .....          | 2-1  |
|                           | Infantry Division .....  | 2-3  |
|                           | Mechanized Infantry Division .....                               | 2-9  |
| <b>Chapter 3</b>          | <b>Motorized Infantry and Infantry Brigades</b> .....            | 3-1  |
|                           | Motorized Infantry Brigade (Separate) .....                      | 3-3  |
|                           | Motorized Infantry Brigade (Divisional) .....                    | 3-6  |
|                           | Infantry Brigade (Separate).....                                 | 3-43 |
|                           | Infantry Brigade (Divisional).....                               | 3-46 |
|                           | Infantry Brigade (Militia).....                                  | 3-54 |
| <b>Chapter 4</b>          | <b>Mechanized Infantry and Tank Brigades</b> .....               | 4-1  |
|                           | Mechanized Infantry Brigade (Separate) .....                     | 4-3  |
|                           | Mechanized Infantry Brigade (Divisional) .....                   | 4-8  |
|                           | Tank Brigade (94-Tank Standard) .....                            | 4-36 |
|                           | Tank Brigade (67-Tank Variant) .....                             | 4-44 |

DISTRIBUTION RESTRICTION: Approved for public release; distribution unlimited.

|                   |   |      |
|-------------------|---|------|
| <b>Chapter 5</b>  | <b>Operational- and Strategic-Level Ground Forces</b> .....               | 5-1  |
|                   | Ground Forces.....  | 5-2  |
|                   | Military Region.....  | 5-3  |
|                   | Expeditionary Army.....   | 5-5  |
|                   | Capital Defense Forces (Example) .....                                    | 5-6  |
|                   | Airborne Infantry Brigade.....  | 5-7  |
| <br>              |   |      |
| <b>Chapter 6</b>  | <b>National Asset Pool</b> .....  | 6-1  |
|                   | National Asset Pool, Ground Forces.....                                   | 6-3  |
|                   | Missile Troops and Artillery, National .....                              | 6-4  |
|                   | Engineer Troops, National .....   | 6-25 |
|                   | Signal Troops, National .....   | 6-46 |
|                   | Chemical Troops, National.....  | 6-47 |
|                   | Logistics Troops, National.....   | 6-53 |
| <br>              |   |      |
| <b>Chapter 7</b>  | <b>National Military Structure</b> .....                                  | 7-1  |
|                   | National Headquarters .....   | 7-2  |
|                   | Special Operations Command .....  | 7-3  |
|                   | Navy.....   | 7-21 |
|                   | Directorate of Military Intelligence, General Staff .....                 | 7-22 |
|                   | Internal Security Forces .....  | 7-25 |
| <br>              |   |      |
| <b>Chapter 8</b>  | <b>Air Force and Air Defense Command</b> .....                            | 8-1  |
|                   | Air Force .....   | 8-2  |
|                   | Air Defense Command .....   | 8-9  |
| <br>              |   |      |
| <b>Appendix A</b> | <b>Maneuver and Fire Support Equipment Substitution Matrixes</b> .....    | A-1  |
|                   | Medium Tank Substitution Matrix .....                                     | A-2  |
|                   | Light Armored Vehicle Substitution Matrix.....                            | A-3  |
|                   | Mortar Substitution Matrix .....  | A-4  |
|                   | Towed Artillery Substitution Matrix .....                                 | A-5  |
|                   | Self-Propelled Artillery Substitution Matrix .....                        | A-6  |
|                   | Rocket Launcher Substitution Matrix.....                                  | A-7  |
|                   | Artillery Rocket and Surface-to-Surface Missile Substitution Matrix ..... | A-8  |
|                   | Antitank Weapon Substitution Matrix.....                                  | A-9  |
|                   | Antiaircraft Gun Substitution Matrix.....                                 | A-11 |
|                   | Surface-to-Air Missile substitution Matrix.....                           | A-12 |
|                   | Attack Helicopter Substitution Matrix.....                                | A-13 |

**Appendix B Engineer Equipment Substitution Matrixes .....B-1**  
Amphibious Transporter and Ferry Substitution Matrix .....B-2  
Bridging Substitution Matrix .....B-3  
Ditching and Trenching Machine Substitution Matrix .....B-5  
Minelaying Equipment Substitution Matrix .....B-6  
Mineclearing Equipment Substitution Matrix .....B-7  
Armored Engineer and Route-Clearing Vehicle Substitution Matrix.....B-9  
Engineer Reconnaissance Vehicle Substitution Matrix.....B-10  
Tank-Mounted Dozer Blade Substitution Matrix .....B-10

**Appendix C Cargo Truck, Trailer, and Radio Substitution .....C-1**  
Trucks .....C-1  
Trailers .....C-2  
Radios .....C-3

**Glossary ..... Glossary-1**

**References.....References-1**

**Index..... Index-1**

## Preface

This manual is one of a series that describes a capabilities-based Opposing Force (OPFOR) for training US Army commanders, staffs, and units. The manuals in this series are-

- FM 100-60. *Armor- and Mechanized-Based Opposing Force: Organization Guide.*
- FM 100-61. *Armor- and Mechanized-Based Opposing Force: Operational Art.*
- FM 100-62. *Armor- and Mechanized-Based Opposing Force: Tactics.*
- FM 100-63. *Infantry-Based Opposing Force: Organization Guide.*
- FM 100-64. *Infantry-Based Opposing Force: Operations and Tactics.*
- FM 100-65. *Opposing Force Equipment Guide.*
- FM 100-66. *Opposing Force in Operations Other Than War.*

Together, these manuals outline an OPFOR that can cover the entire spectrum of military capabilities against which the Army must train to ensure success in any future conflict.

Applications of this series of manuals include field training, training simulations, and classroom instruction throughout the Army. All Army training venues should use an OPFOR based on these manuals, except when mission rehearsal or contingency training requires maximum fidelity to a specific country-based threat. Even in the latter case, trainers should use appropriate parts of this capabilities-based OPFOR to fill information gaps in a manner consistent with what they do know about a specific threat.

This manual provides a menu of possible organizational building blocks for an infantry-based OPFOR. From this menu, users can build an order of battle appropriate to their training requirements. For each type of unit, the manual outlines basic unit structure and possibly a number of variations. For most units, the manual also lists principal items of equipment. Appendixes provide guidance and examples for users who wish to substitute other items of equipment for the baseline systems listed for a unit.

The proponent for this publication is HQ TRADOC. Send comments and recommendations on DA Form 2028 directly to the Threat Support Directorate of the TRADOC Office of Deputy Chief of Staff for Intelligence at the following address: Director, Threat Support Directorate, ATTN: ATIN-L-T (Bldg 53), 700 Scott Avenue, Fort Leavenworth, KS 66027-1323

Nomenclatures of weapons and equipment in this publication are in compliance with international standardization agreements (STANAGs) 2097 and 3236. Unless this publication states otherwise, masculine nouns and pronouns do not refer exclusively to men.

# Introduction

This organization guide is part of the field manual (FM) series 100-60 that documents the **capabilities-based Opposing Force (OPFOR)**. This series provides a flexible OPFOR package that users can tailor to represent a wide range of potential threat capabilities and organizations. The overall package features an armor- and mechanized-based OPFOR module and an infantry-based OPFOR module, each containing FMs describing organizations, operations, and tactics. Completing the package are FMs on OPFOR equipment and on other OPFORs in peace and conflict.

This introduction provides definitions of some basic terms used throughout the manual. For definitions of other key terms, the reader should refer to the index, where page numbers in bold type indicate the main entry for a particular topic. That page often includes a definition of the indexed term.

## **OPFOR VERSUS THREAT**

The OPFOR is a training tool for preparing the Army to respond to a wide variety of threats. The following paragraphs explain the difference between an OPFOR and a threat and the relationships between the two.

### **Threat and Country-Based OPFOR**

A **threat** can be any specific foreign nation or organization with intentions and military capabilities that suggest it could become an adversary or challenge the national security interests of the United States or its allies. As the Army moves into the twenty-first century, it is no longer possible to identify one or two nations or forces as the potential adversaries against which it needs to train on a regular basis.

When conflict is imminent or when US forces need to train for a particular contingency, training may focus on a specified threat force. This rehearsal for an actual mission or operation can involve a **country-based OPFOR**. Such an OPFOR should portray the specified, real-world threat force with the greatest possible fidelity, based on the best available classified and unclassified information. Cases may exist in which constraints on the use of classified information or the lack of information, at any level of classification, preclude the use of actual threat data. To fill in gaps, in such cases, trainers could use those parts of the capabilities-based OPFOR that are most consistent with what they do know about a specific threat.

### **Capabilities-Based OPFOR**

In more typical cases, however, the US Army simply needs to train against an OPFOR that represents a particular level of capability rather than a particular country. The **capabilities-based OPFOR** is a realistic and flexible armed force representing a composite

of varying capabilities of actual worldwide forces. It constitutes a baseline for training or developing US forces, in lieu of a specific threat force. This baseline includes doctrine, tactics, organization, and equipment. It provides a challenging, uncooperative sparring partner that is representative, but not predictive, of actual threats.

The capabilities-based OPFOR represents a break from past practices on two principal respects. First, the armor- and mechanized-based and infantry-based OPFOR modules are not simply unclassified handbooks on the armed forces of a particular nation. Rather, each module has its basis in the doctrine and organization of various foreign armies. These OPFOR modules are *composites* deliberately constructed to provide a wide range of capabilities. Secondly, the modules do not provide a fixed order of battle. Rather, they provide the *building blocks* from which users can derive an infinite number of potential orders of battle, depending on their training requirements.

The primary purpose of these FMs is to provide the basis for a realistic and versatile OPFOR to meet US military training requirements. They can support training in the field, in classrooms, or in automated simulations. However, users other than trainers may apply these FMs when they need an unclassified threat force that is not country-specific.

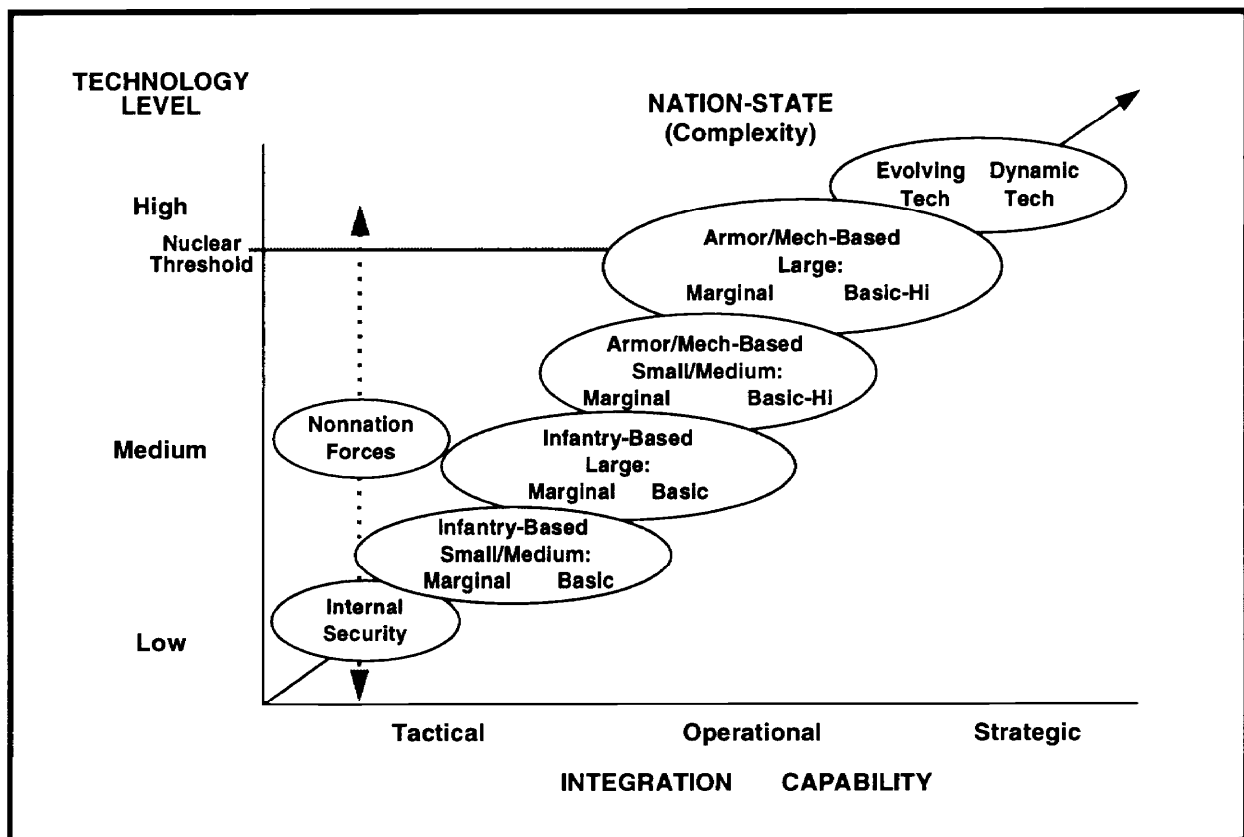

Spectrum of military capabilities.

## INFANTRY-BASED OPFOR MODULE

The infantry-based OPFOR represents the armed forces of a developing country with limited resources. The name of that country is ***the State***. The State's military structure consists primarily of ground forces. The formal name of this branch of the armed forces that corresponds to the US Army is the ***Ground Forces***. These Ground Forces are primarily infantry (dismounted or motorized), with relatively few mechanized infantry and tank units and perhaps some air-borne infantry units. Aside from the Ground Forces, the State's armed forces may include any or all of the following components:

- The Air Force, including the Air Defense Command.
- The Special Operations Command, with commando and special-purpose forces.
- The Navy, consisting of a small, brown-water force.

This OPFOR can also include less capable forces, to include internal security forces, the militia, and reserves. This menu of possible forces allows US military trainers to tailor the OPFOR order of battle to meet virtually any training requirement involving an infantry-based force.

Infantry-based forces are common throughout the developing world. These forces have some armor but rely on dismounted or motorized infantry for the bulk of their combat power. At the most, they conduct set-piece operations, integrating arms at the tactical level. None of these forces is capable of meeting the most advanced armies on an even footing in conventional battle. In many respects, the infantry-based OPFOR resembles the armies of World War I, with more lethal weaponry.

### **Size and Capability**

The infantry-based OPFOR module includes a range of potential forces that can vary in size and capability. ***Small-to-medium infantry forces*** have marginal integration capability (ability to conduct tactical-level combat actions with limited fire support) or basic integration capability (ability to conduct battalion-level tactical combined arms actions). In terms of technology, both groups import most of their systems. ***Large infantry forces*** can conduct extensive set-piece operations over broad frontages. However, they are capable of projecting military power only within their region. The key technologies that can allow this are self-propelled artillery and offensive chemical and biological warfare. The State may or may not have chemical and biological weapons, but has the capability to produce or acquire them. A country with large infantry forces can have extensive, basic weapons industries, or it may still import most systems. Although this larger force may have improved communications, the OPFOR must rely on outside states for use of communications satellites.

When opposed by an adversary of similar capabilities, an infantry-based OPFOR can conduct conventional, force-oriented combat. However, when faced with a large, technologically advanced army, it is likely to attempt to redefine the terms of conflict and pursue its aims through terrorism, insurgency, or partisan warfare. In the case of intervention by an external power or coalition, this strategy aims to undermine the enemy's will to continue the conflict without the necessity of defeating his main forces on the battlefield.<sup>1</sup>

---

<sup>1</sup>Throughout the FM 100-60 series, the term ***enemy*** refers not to the OPFOR but rather to the enemy of the OPFOR.

## FM 100-63

FM 100-63, *infantry-Based Opposing Force: Organization Guide*, depicts the forces of a country divided geographically into an unspecified number of military regions, each with a number of subordinate military districts. This OPFOR stations most combat forces within the military districts, which can vary widely in their strengths and capabilities. The guide allows for standing divisions, but districts with separate brigades would be much more common and in keeping with the spirit of the infantry-based OPFOR concept. At most, the State could mobilize and deploy one army-sized force capable of conducting large-scale operations against a neighboring country whose armed forces are also infantry-based. If the trainer finds himself building multiple standing divisions and armies, it may be that FM 100-60 better suits his training needs. He may find it necessary to draw some elements from both organization guides in order to constitute the appropriate OPFOR order of battle.

### **Compared to Armor- and Mechanized-Based OPFOR**

The infantry-based OPFOR differs from the armor- and mechanized-based OPFOR primarily in terms of size, technological level, and the ability to integrate arms into operations. FM 100-60, *Armor- and Mechanized-Based Opposing Force: Organization Guide*, depicts the forces of a developed State with extensive resources devoted to maintaining a military capability that rivals that of the United States. It has a strategic capability, with strategic air and air defense forces and strategic missile forces. It probably has a nuclear capability. Unless the State is landlocked, it can have a blue-water navy and naval infantry (marines).

In the armor- and mechanized-based OPFOR, the ground forces are still the largest component. Compared to the infantry-based OPFOR, these ground forces have more standing divisions or brigades. Rather than being subordinate to military regions and districts, these divisions and separate brigades constitute several standing armies or corps. Most of these forces are in turn subordinate to army groups. Armies, corps, and army groups can vary widely in their strengths and capabilities. Even multiple army groups may come under a series of theater headquarters that orchestrate complex, large-scale operations.

The armor- and mechanized-based OPFOR can conduct a strategic operation involving the combined forces in a theater. These forces may comprise-

- Several army groups.
- Strategic nuclear forces (strategic missile forces and strategic aviation).
- Strategic air armies.
- National air defense forces.
- A naval fleet.
- Naval infantry forces.
- Airborne forces.
- Special-purpose forces.
- National space forces.

Trainers may use any or all of these elements in an OPFOR order of battle as required.



**Armor- and mechanized-based forces** are the norm throughout the industrialized world. Such armies normally mount at least 40 percent of their forces in armored vehicles. They tend to modernize selected systems to match the best systems deployed by their neighbors. In terms of equipment and size, they range from small forces fielding outmoded equipment through large, capable forces fielding state-of-the-art weapons. For the most part, they still base their tactics and doctrine on World War II, either their own experience or that of their arms/doctrine suppliers. Many of these nations produce and export weapons and technology up through state-of-the-art-systems. Significant technologies that mark this class are in fire support and target acquisition.

**Small-to-medium armor- and mechanized-based forces** cover a wide range of technology and capability, from developing states through small, professional armies. **Large armor- and mechanized-based forces** often have more sophisticated weaponry: they field self-propelled artillery and multiple rocket launchers, artillery-delivered high-precision munitions, medium-to-heavy tanks, and limited thermal capability. This group may or may not have nuclear weapons but at least has the capability to produce or acquire them. Armor- and mechanized-based forces can conduct large-scale, combined arms operations. Joint operations are the norm in the more advanced states. These states have the logistics and command structures necessary to conduct continuous operations. Some armor- and mechanized-based forces are capable of sustained power-projection operations.

The high-technology end of the armor- and mechanized-based OPFOR approaches the level termed **complex, adaptive forces**. From developed nations, these most technically and tactically advanced forces can choose quality over quantity. As they modernize, they can reduce in size and still maintain a high level of military capability. These forces normally have a complex structure, with more specialized units operating highly sophisticated equipment. They are also capable of adapting to dynamic situations and seizing opportunities on the battlefield. However, such a force is exceedingly expensive to equip, train, and maintain.

Thus, the differences between the infantry-based and armor- and mechanized-based OPFOR modules are largely **scenario-dependent**. A particular training scenario may not require a large array of standing forces or justify the extensive use of mechanized infantry or tank forces. In such a case, it may be that FM 100-63 better fits the training needs.

### **Compared to Other OPFORs in Peace and Conflict**

Compared to either of the OPFOR modules described above, other OPFORs in peace and conflict are less well defined. By their very nature, they are unpredictable. They too differ from the infantry-based OPFOR primarily in terms of size, technological level, and the ability to integrate arms into operations. In such a case, however, most military forces have lower capability than the infantry-based OPFOR. FM 100-66 depicts a variety of such forces that US forces may encounter.

On the one hand, these may be the forces of a **preindustrial nation or a nonnation group with limited assets**. Such groups cannot, or will not, invest in the weapons and technology necessary to keep pace with the best militaries in their regions. Most of their military organizations

are *ad hoc* rather than standing organizations with predictable structures. These forces range in size from irregular forces, constabularies, and internal security forces to light infantry units. There is no such thing as a standard light infantry force; they come in all shapes and sizes. The common thread is that they have little or no organic, heavy equipment.

Like the lower end of the infantry-based OPFOR, these forces are likely to attempt to deal with a larger, more technologically advanced army through terrorism, insurgency, or partisan warfare. They do not try to meet such an enemy head-on in conventional combat. They prefer hit-and-run raids, ambushes, ruses, sabotage, and assassinations. They try to be unpredictable and invisible to view, employing methods not anticipated by their enemies. They do not fight by the rules of conventional warfare.

On the other hand, these OPFORs may also include forces that are better-equipped and better-trained. Such a force may be part of or sponsored by a wealthy criminal element or have the backing of a wealthy outside power. It may still be small and lightly armed but could have sophisticated, state-of-the-art light weapons. The force is light not out of austerity but for practical reasons, because the lightness of the equipment enhances mobility. It may also have high-technology communications and reconnaissance means.

Lastly, there may be occasions where the OPFORs in peace or conflict include a sophisticated military organization with heavier weapons. If the US force is participating in a peacekeeping operation, for example, the OPFOR may be the recognized military of a belligerent nation. As such, it could include infantry-based or armor- and mechanized-based forces of the types found in FMs 100-63 and 100-60, respectively. Likewise, some of the types of OPFOR described in FM 100-66 can also appear during war.

## **ORGANIZATION CHARTS**

The organization charts in this guide focus on maneuver units. They begin with the largest maneuver units and work down to the smallest. Whenever feasible, the guide breaks down subordinate maneuver units, as well as combat support and combat service support units, in greater detail.

### **Maneuver Units**

Since *motorized infantry* units are the most common in this infantry-based OPFOR, these units come first in this organization guide. Such units differ from regular *infantry* primarily by having trucks available to transport all elements subordinate to the unit when necessary. The distinction between infantry and motorized infantry becomes clear only at brigade level, since the trucks for movement of infantry are organic to motorized infantry brigades. Within either type of brigade, the basic maneuver units from squad through company are simply infantry. At battalion level, there are no organic trucks for transporting any infantry companies, although the infantry battalion headquarters has a few. The motorized infantry battalion also has some wheeled vehicles in its signal and logistics support elements. At battalion level and higher, subordinate units common to both infantry and motorized infantry have their basic entry only under the motorized parent unit.

Following the infantry and motorized infantry units, in descending order of likelihood, come the **mechanized infantry** and **tank** units. Even an infantry-based OPFOR usually has some armored and mechanized forces. Again, any subordinate units common to both mechanized infantry or tank units and motorized infantry units do not repeat.

In OPFOR terminology, a **separate** unit is one that is not subordinate to a parent unit of the same arm. For example, a separate tank battalion is not part of a tank brigade. However, it may be part of a mechanized infantry brigade or directly subordinate to a motorized infantry, infantry, or mechanized infantry division. (The infantry-based OPFOR has no tank divisions.) Similarly, a separate motorized infantry brigade is not part of a motorized infantry division (or any division, for that matter). It is directly subordinate to a military district or an army. In contrast, a **divisional** brigade is always part of a division.

The basic maneuver unit is the **brigade** consisting of three or four maneuver battalions and a wide array of combat support and combat service support elements. Some infantry-based forces, however, may call the same organization a **regiment**. In this case, the difference in terminology is merely semantic and does not signify a different structure or capability.

### **Combat Support and Combat Service Support Units**

Aside from **organic** combat support and combat service support units, Ground Forces maneuver units may receive additional support from the **national asset pool**. The General Staff/Ground Forces Headquarters can use such units, listed as **national**, to tailor support to various Ground Forces organizations. The numbers and types of units in the national asset pool can vary according to the situation. Their inclusion in this guide merely provides an option for, but does not mandate their inclusion in any order of battle developed from this guide. Users should determine the proper sizing and allocation of the national asset pool based on training requirements.

### **Flexibility Within Realistic Limits**

Headings within each chapter indicate the name of the specific unit depicted and of all organizations to which this type of unit may be subordinate. Organization charts depict all possible subordinate units. If training objectives do not require the use of all elements shown in a particular organization, **users can omit the elements they do not need**. Some organization charts have blocks showing two alternatives for a particular type of subordinate unit. For example, a military district might have either an engineer company or an engineer battalion. In most cases, the unit listed first is the norm, but the other alternative is an option. Many organization charts have notes and/or footnotes that identify possible variations in organizational structure or equipment. These alternatives allow users to select the basic organization or the variation that best suits their training requirements.

**Stacked blocks** in the organization charts indicate multiple, identical units subordinate to a particular organization. **Dashed blocks** indicate units that may or may not be present in the type of organization shown.

Users must ensure that the size and composition of the OPFOR is sufficient to meet training objectives and requirements. However, total assets organic to a Ground Forces organization or allocated to it from higher levels should not exceed that which is *realistic and appropriate* to the training scenario. Skewing the force ratio in either direction negates the value of training.

### **Page References for Detail**

In the main organization chart for any parent unit, subordinate units defined elsewhere in greater detail have *page references* beneath their block in the organization chart. This approach can lead the user to the subordinate unit, even if its organization chart appears in another chapter or another part of the same chapter. To avoid excessive duplication, subordinate units common to several types of parent unit receive detailed treatment only once, with subsequent cross-references back to that basic entry. Units without such page references do not have separate entries with further detail.

Occasionally, there may be a small unit that does not have its own organization chart showing further subordinates. However, the user may find a page reference leading to the parent unit's table of principal items of equipment, which breaks down equipment totals by subordinate units, including this one.

## **PRINCIPAL ITEMS OF EQUIPMENT**

For organizations of brigade size or smaller, this book provides a table of principal items of equipment. For brigades and regiments, as well as selected battalions, this table provides a quick overview of the holdings for subordinate units and equipment totals for the unit as a whole. Units above brigade/regiment level either have no fixed structure or have so many variations in possible structure that equipment totals are difficult to quantify. Therefore, the organization guide leaves those specifics to users who build actual orders of battle for a specific OPFOR in a specific scenario. The OPFOR order of battle must meet the user's training requirements, based on the menu of possible organizational parts provided in this manual.

Equipment totals include individual weapons only at maneuver battalion level and below. The same is true of night-vision devices (goggles and sights). These figures vary widely from unit to unit, although separate brigades tend to field more goggles in combat support and combat service support units than do divisional brigades. With the exception of maneuver units (battalion and below), accounting for the varying numbers of night-vision devices, especially the goggles worn by vehicle drivers, is difficult.

This guide provides example equipment types and the numbers of each type typically found in specific organizations. The purpose is to give users a good idea of what an OPFOR structure should look like. However, training requirements may dictate some modifications to this baseline. Users should exercise caution in modifying equipment holdings, since this impacts on an OPFOR unit's organizational integrity and combat capabilities.

## **Baseline Equipment**

A developing country may equip its infantry-based OPFOR primarily with systems imported from more advanced, weapons-producing countries. For illustrative purposes, the equipment lists in this manual show systems produced by the former Soviet Union (FSU). There are two reasons for using FSU-produced equipment as the baseline. First, many potential threat countries have equipped their armed forces with systems that the FSU and its successor states have built in large numbers and ***proliferated widely*** throughout the world. Second, this equipment is ***representative of a unit's or force's technological capability***. Listing these familiar, well-documented systems paints an immediate, concrete picture of that capability. Listing generic equipment descriptors, such as *medium tank* or *antitank guided missile*, would not create such a clear impression of capabilities. Moreover, generic descriptors would not lead to the development of consistent equipment sets. This organization guide, therefore, normally uses generic descriptors only when the choice of systems would not materially affect basic unit or force capabilities.

## **Equipment Substitution**

To achieve specific training objectives or merely to provide variety in the training environment, users can substitute other equipment for those listed as the baseline. Appendix A contains matrices with suggested examples of appropriate substitutions for major maneuver and fire support systems. Appendix B does the same for engineer equipment. Appendix C lists examples of cargo trucks, trailers, and radios corresponding to the generic descriptors used in equipment lists. Each appendix also provides general guidelines for the substitution process.

Appendixes A, B, and C are guides; they cannot be all-inclusive, listing every conceivable system available worldwide. In constructing an OPFOR order of battle, therefore, trainers may substitute systems not listed in the appendixes. However, they should follow the same general philosophy and the guidelines prescribed in the appendixes. To assist in the substitution process, FM 100-65, *Opposing Force Equipment Guide*, will present a wider selection of major systems from which users may choose.

# Chapter 1

## Military Districts and Motorized Infantry Divisions

Military districts and maneuver divisions are the highest-level tactical organizations in the Ground Forces. Military districts are geographical entities, but are also a level of command. Districts generally contain one or more separate brigades (infantry, motorized infantry, or mechanized infantry) and perhaps a tank brigade. However, a district may have a standing division (infantry, motorized infantry, or mechanized infantry) based on divisional brigades. For more information on infantry and mechanized infantry divisions, see Chapter 2. For more information on separate and divisional brigades, see Chapters 3 and 4.

Divisions can be either standing or mobilized from the reserves. Standing divisions may exist in districts along an international border, in districts that contain historically threatened avenues of approach, or around critical cities or facilities. Divisions mobilized from the reserves may draw combat support and combat service support from reserves or receive them from the national asset pool. The commander of the district in which a division is garrisoned or mobilized is also the division commander, as long as the division remains in that district.

### CONTENTS

|   |      |
|---|------|
| <b>Military District</b> .....  | 1-3  |
| <b>Motorized Infantry Division</b> .....  | 1-5  |
| Division Headquarters, Mtzd Inf Div, Inf Div, and Mech Inf Div .....                                    | 1-6  |
| Separate Tank Battalion, Mtzd Inf Div, Inf Div, and Mech Inf Div,<br>or Mech Inf Bde (Sep and Div)..... | 1-7  |
| Engineer Platoon, Separate Tank Bn .....  | 1-8  |
| Signal Section, Separate Tank Bn.....   | 1-9  |
| Maintenance Section, Separate Tank Bn .....   | 1-9  |
| Support Platoon, Separate Tank Bn.....  | 1-10 |
| Medical Section, Separate Tank Bn.....  | 1-10 |
| Artillery Regiment, Mtzd Inf Div and Inf Div, or MD or Army or National .....                           | 1-11 |
| Headquarters and Control Battery, Arty Regt or Arty Bde or MRL Bde.....                                 | 1-14 |
| 122-mm Howitzer Battalion, Mtzd Inf Bde (Sep) and Inf Bde (Sep),<br>or Arty Regt .....                  | 1-15 |
| 122-mm Howitzer Battery, 122-mm Howitzer Bn .....   | 1-16 |
| 152-mm Gun-Howitzer Battalion, Arty Regt or Arty Bde .....  | 1-17 |
| 152-mm Gun-Howitzer Battery, 152-mm Gun-Howitzer Bn.....  | 1-18 |
| 122-mm Multiple Rocket Launcher Battalion, Arty Regt and SP Arty Regt,<br>or MRL Bde .....              | 1-19 |
| Headquarters and Control Platoon, 122-mm MRL Bn .....   | 1-20 |
| Firing Battery, 122-mm MRL Bn .....   | 1-20 |
| Materiel Support Platoon, 122-mm MRL Bn .....   | 1-21 |

|   |      |
|---|------|
| Target Acquisition Battery, Arty Regt or Arty Bde or MRL Bde.....                                       | 1-22 |
| Materiel Support Company, Arty Regt and SP Arty Regt, or Arty Bde or MRL Bde...                         | 1-23 |
| Maintenance Company, Arty Regt and SP Arty Regt, or Arty Bde or MRL Bde .....                           | 1-23 |
| Antiaircraft Gun Regiment (57-mm), Mtzd Inf Div and Inf Div, or MD or Army<br>or ADC.....               | 1-24 |
| Regimental Headquarters, AA Gun Regt (57-mm) .....  | 1-26 |
| Fire Control Battery, AA Gun Regt (57-mm).....  | 1-27 |
| Antiaircraft Gun Battery (57-mm), AA Gun Regt (57-mm) or AA Gun Bn (57-mm)<br>or AA Gun Bn (Mixed)..... | 1-28 |
| Service Battery, AA Gun Regt (57-mm) .....  | 1-29 |
| Antitank Battalion (Standard), Mtzd Inf Div or MD or Army or National .....                             | 1-30 |
| Antitank Gun Battalion, Mtzd Inf Div and Inf Div, or MD or Army or National .....                       | 1-31 |
| Battalion Headquarters, Antitank Bn (Standard) or Antitank Gun Bn or ATGM Bn ...                        | 1-32 |
| Antitank Gun Battery, Antitank Bn (Standard) or Antitank Gun Bn.....                                    | 1-32 |
| ATGM Battery, Antitank Bn or ATGM Bn.....   | 1-33 |
| Materiel Support Platoon, Antitank Bn or Antitank Gun Bn or ATGM Bn.....                                | 1-34 |
| Reconnaissance and Electronic Combat Battalion, Mtzd Inf Div and Inf Div,<br>or MD or Army or DMI ..... | 1-35 |
| Headquarters and Service Company, Recon & EC Bn.....  | 1-37 |
| Reconnaissance Company, Recon & EC Bn, Mtzd Inf Div and Inf Div,<br>or MD or Army or DMI .....          | 1-38 |
| Long-Range Reconnaissance Company, Recon & EC Bn.....   | 1-39 |
| Signals Reconnaissance Company, Recon & EC Bn.....  | 1-40 |
| Jamming Company, Recon & EC Bn .....  | 1-41 |
| RPV Squadron, Recon & EC Bn .....   | 1-42 |
| Chemical Defense Company, Mtzd Inf Div and Inf Div, or MD .....   | 1-43 |
| Materiel Support Battalion, Mtzd Inf Div and Inf Div, or MD<br>or Army or National.....                 | 1-44 |
| Battalion Headquarters, Mat Spt Bn or Motor Transport Bn.....   | 1-45 |
| Ammunition Transport Company, Mat Spt Bn .....  | 1-45 |
| POL Transport Company, Mat Spt Bn .....   | 1-46 |
| Cargo Transport Company, Mat Spt Bn .....   | 1-46 |
| Maintenance Platoon, Mat Spt Bn .....   | 1-47 |
| Supply and Service Platoon, Mat Spt Bn.....   | 1-47 |
| Mobile Field Bakery, Mat Spt Bn.....  | 1-47 |
| Maintenance Battalion, Mtzd Inf Div or MD or MR or Army or CDF or National .....                        | 1-48 |
| Battalion Headquarters, Maint Bn .....  | 1-49 |
| Tracked Vehicle Maintenance Company, Maint Bn.....  | 1-49 |
| Wheeled Vehicle Maintenance Company, Maint Bn.....  | 1-50 |
| Ordnance Maintenance Company, Maint Bn.....   | 1-50 |
| Supply and Service Platoon, Maint Bn, Mtzd Inf Div or MD .....  | 1-51 |
| Recovery Platoon, Maint Bn, Mtzd Inf Div and Inf Div, or MD.....  | 1-51 |
| Special Maintenance Platoon, Maint Bn.....  | 1-51 |
| Medical Company, Mtzd Inf Div, Inf Div, and Mech Inf Div, or MD .....                                   | 1-52 |

## Military District

Military districts are *geographical* entities which delineate the territorial responsibilities and disposition of forces subordinate to a military region (see p. 5-3). There is *no standard composition* for forces within a district. The number and types of units can vary widely from district to district. Therefore, the following organization chart merely outlines the types of units and facilities that might or might not be present in a given district.

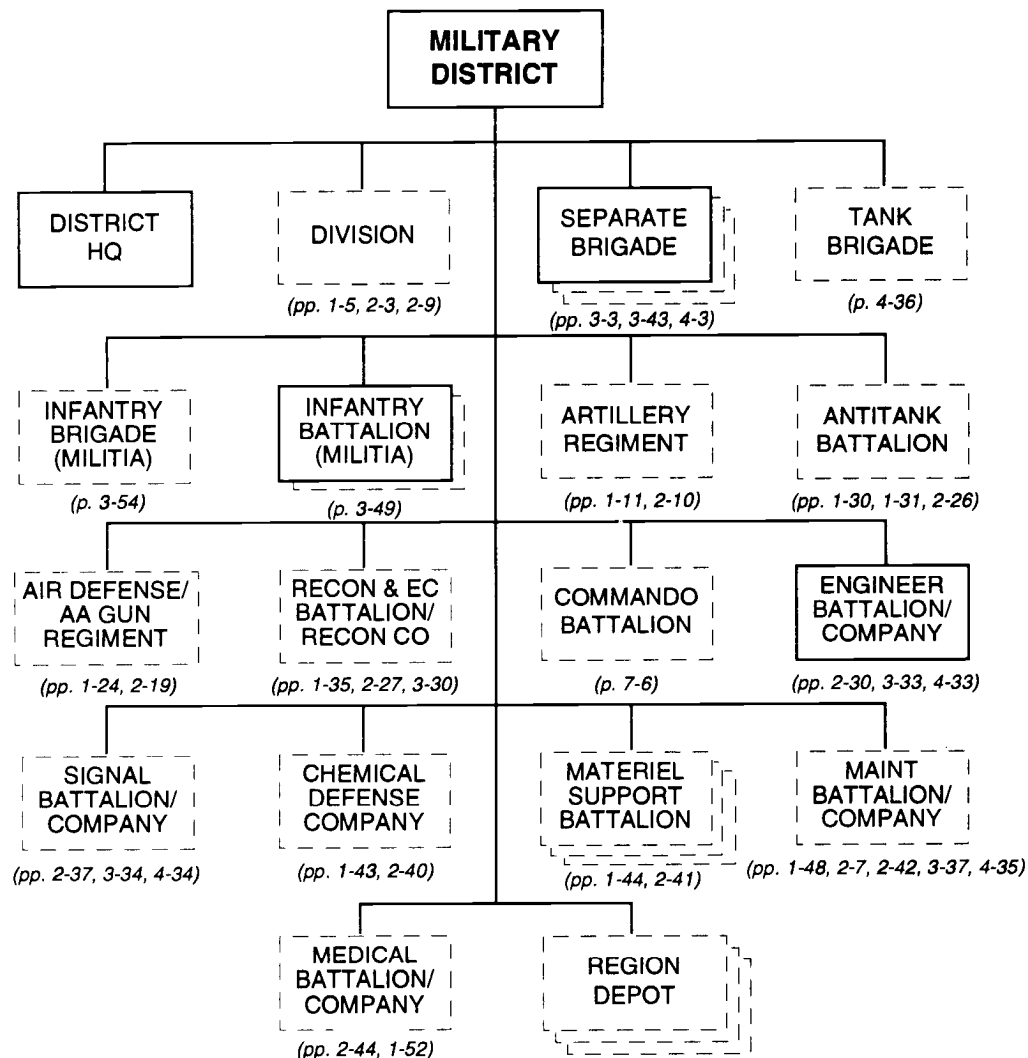

### NOTES:

1. Districts generally contain one or more separate brigades, but may have a standing division (infantry, motorized infantry, or mechanized infantry). During mobilization, a district may form a division from the reserves, possibly using a separate brigade as a mobilization base. However, this would occur only in a high-priority district. Even a district with a standing division in peacetime might have that division resubordinated to a higher-priority district or region in war-time.

(continued)



**Military District (continued)** \_\_\_\_\_

2. A basically rural, mountainous district with no major population centers may have only one or two separate infantry brigades, with little or no additional combat support and combat service support. In addition to these regular army forces, such a district may have a single militia infantry battalion.
3. A district astride a major avenue of approach, or one that contains several major population/industrial centers, may contain two or three separate infantry brigades (or motorized or mechanized infantry) and perhaps a tank brigade. Such a district is more likely to have some of the additional combat support and combat service support assets allocated from the national level through the region. Depending on the size of its population centers, a district might be able to constitute a brigade-sized militia force, or at least multiple battalions.
4. A district may have organic or allocated artillery, antitank, and air defense units. If a district's maneuver units are predominantly mechanized infantry and tank forces, these fire support units are more likely to be self-propelled. If the maneuver units are infantry or motorized infantry, the fire support units are more likely to be towed.
5. One high-priority district is the Capital District, which contains the State's national capital. The Capital Defense Forces garrisoned there are typically the best-equipped in the country. They are specially tailored for their primary mission of defending the capital and for their secondary mission as the strategic reserve. (See p. 5-6.)

## Motorized Infantry Division

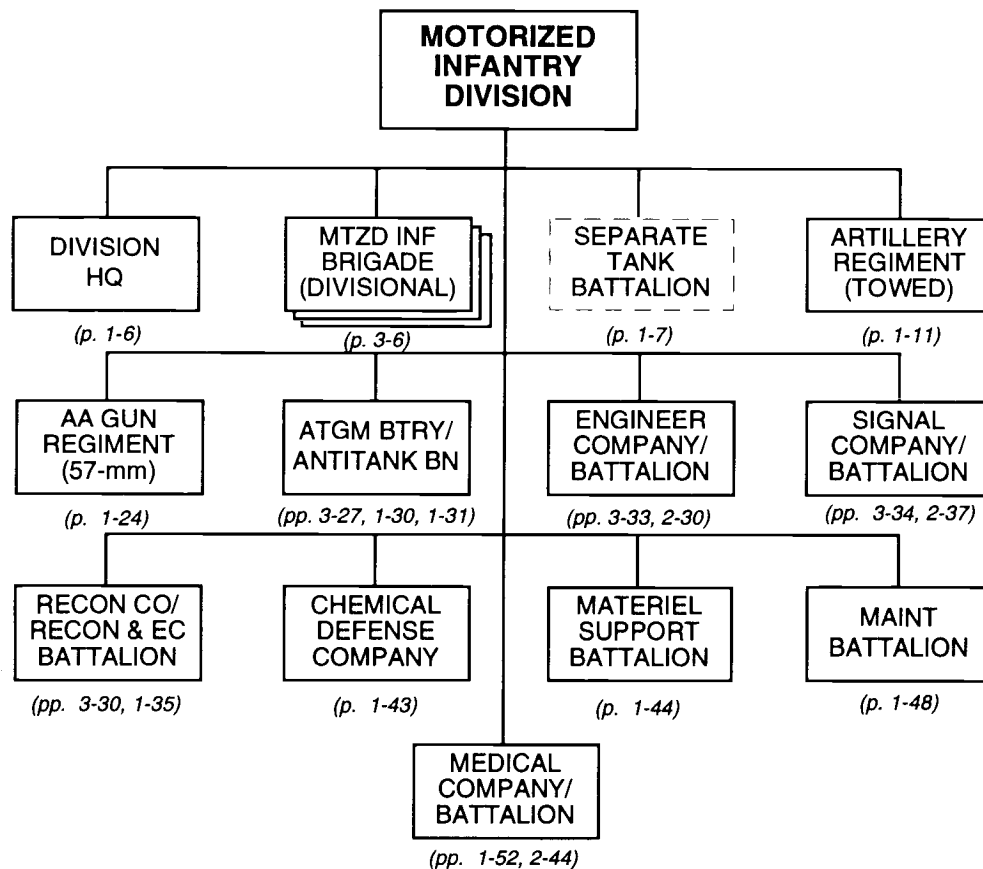

### NOTES:

1. The basic maneuver units in this division are three motorized infantry brigades (divisional). These divisional brigades differ structurally from their separate counterparts normally found within military districts. In addition to its motorized infantry brigades, this division may or may not have a separate tank battalion.
2. Most motorized infantry divisions have an ATGM battery and company-sized engineer, signal, reconnaissance, and medical units. However, some better-equipped motorized infantry divisions may have battalion-sized antitank, engineer, signal, reconnaissance (and EC), and medical units.
3. Motorized and mechanized infantry divisions are the basic maneuver formations of an expeditionary army (see p. 5-5). Such an army, mobilized in one military region to conduct large-scale offensive operations, may include divisions resubordinated from other regions or districts.
4. Divisions can be either standing or mobilized from the reserves. Standing divisions may exist in districts along an international border, in districts that contain historically threatened avenues of approach, or around critical cities/facilities. Standing divisions have the assets shown above, even before mobilization. Divisions mobilized from the reserves may draw the combat support and combat service support shown above from reserves or receive them from the national assets pool. The commander of the district in which a division is garrisoned or mobilized is also the division commander, as long as the division remains in that district.
5. Motorized infantry divisions are more common than mechanized or infantry divisions.

Division Headquarters, Mtzd Inf Div, Inf Div,  
and Mech Inf Div \_\_\_\_\_

|   |
|---|
| <p><b>DIVISION<br/>HEADQUARTERS</b></p> |
|---|

**PRINCIPAL ITEMS OF EQUIPMENT**

| <u>Equipment</u>              | <u>Total</u> | <u>Equipment</u>                | <u>Total</u> |
|-------------------------------|--------------|---------------------------------|--------------|
| SAM, Shoulder-Fired.....      | 6            | Trailer, Cargo, 1-Axle.....     | 4            |
| ATGL, RPG-7V.....             | 3            | Trailer, Generator.....         | 3            |
| 5.45-mm LMG, RPK-74.....      | 3            | Trailer, Kitchen.....           | 3            |
| APC, BTR-60/70/80.....        | 3            | Trailer, POL (4,200-Liter)..... | 1            |
| Truck, Utility.....           | 12           | Trailer, Water (900-Liter)..... | 1            |
| Truck, Light.....             | 9            | Radios:                         |              |
| Truck, Medium.....            | 4            | VHF, Vehicle Mount,             |              |
| Truck, POL (5,000-Liter)..... | 1            | Medium-Power.....               | 3            |
| Van, Command.....             | 12           | VHF, Manpack, Low-Power.....    | 5            |
| Van, Maintenance.....         | 1            | HF/VHF, Vehicle Mount,          |              |
| Van, Signal.....              | 2            | High-Power.....                 | 2            |
| Ambulance.....                | 1            | Warning Receiver.....           | 1            |

**NOTES:**

1. Standing divisions normally have a headquarters as shown above.
2. Divisions mobilized from reserves may have a smaller headquarters element. Such a headquarters may be more like the headquarters of the separate brigade that served as a mobilization base for the division.

Separate Tank Battalion, Mtzd Inf Div, Inf Div, and Mech Inf Div,  
or Mech Inf Bde (Sep and Div)

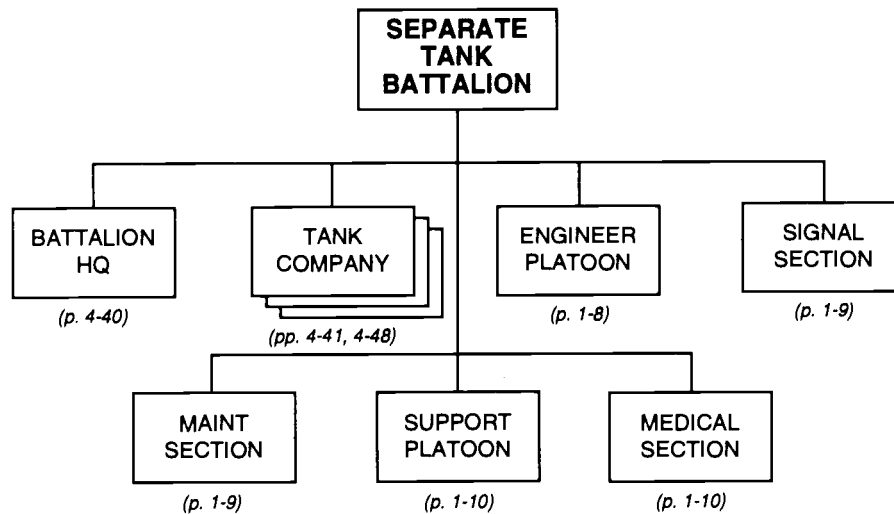

**PRINCIPAL ITEMS OF EQUIPMENT**

| <u>Equipment</u>                                 | <u>22-Tank</u> | <u>31-Tank</u> | <u>Equipment</u>                          | <u>22-Tank</u> | <u>31-Tank</u> |
|--|----------------|----------------|---|----------------|----------------|
| Medium Tank, T-55K/62K<br>(Command Vehicle)..... | 1              | 1              | Mine Roller-Plow .....                    | 3              | 3              |
| Medium Tank, T-55/62.....                        | 21             | 30             | Dozer Blade, BTU .....                    | 1              | 1              |
| ACV, BTR (R-145BM) .....                         | 2              | 2              | Route-Clearing Vehicle,<br>BAT/PKT.....   | 1              | 1              |
| ACV, BMP-1K/2K .....                             | 1              | 1              | Trailer, Cargo, 1-Axle.....               | 1              | 1              |
| ATGL, RPG-7V.....                                | 2              | 2              | Trailer, Cargo, 2-Axle.....               | 7              | 7              |
| 9-mm Pistol, PM.....                             | 80             | 110            | Trailer, Generator.....                   | 3              | 3              |
| 5.45-mm Assault Rifle,<br>AK-74/AKS-74.....      | 73             | 79             | Trailer, POL (4,200-Liter) .....          | 4              | 5              |
| Flamethrower, LPO/RPO.....                       | 2              | 2              | Trailer, Water (900-Liter) .....          | 1              | 1              |
| Truck, Utility .....                             | 1              | 1              | Night-Vision Goggles .....                | 2              | 2              |
| Truck, Light .....                               | 1              | 1              | Night-Vision Sight<br>(Small Arms) .....  | 11             | 11             |
| Truck, Medium .....                              | 12             | 13             | Radios:                                   |                |                |
| Truck, Crane .....                               | 1              | 1              | VHF, Manpack,<br>Low-Power.....           | 5              | 5              |
| Truck, POL (5,000-Liter).....                    | 4              | 5              | VHF, Vehicle Mount,<br>Medium-Power ..... | 28             | 37             |
| Van, Kitchen .....                               | 1              | 1              | HF, Manpack,<br>Low-Power.....            | 2              | 2              |
| Van, Maintenance .....                           | 1              | 1              | HF, Vehicle Mount,<br>Medium-Power .....  | 6              | 6              |
| Van, Signal.....                                 | 2              | 2              | Radio Relay, VHF/UHF.....                 | 2              | 2              |
| Ambulance .....                                  | 1              | 1              | Warning Receiver .....                    | 1              | 1              |
| Armored Recovery Vehicle .....                   | 2              | 2              |   |                |                |
| Bridge, Tank-Launched .....                      | 1              | 1              |   |                |                |
| Ditching Machine,<br>BTM/MDK .....               | 1              | 1              |   |                |                |
| Mineclearing Plow .....                          | 6              | 9              |   |                |                |

Engineer Platoon, Separate Tank Bn \_\_\_\_\_

|                             |
|-----------------------------|
| <b>ENGINEER<br/>PLATOON</b> |
|-----------------------------|

**PRINCIPAL ITEMS OF EQUIPMENT**

| <u>Equipment</u>                     | <u>Total</u> | <u>Equipment</u>                     | <u>Total</u> |
|--------------------------------------|--------------|--------------------------------------|--------------|
| 9-mm Pistol, PM.....                 | 1            | Dozer Blade, BTU .....               | 1            |
| 5.45-mm Assault Rifle AK-74.....     | 10           | Truck, Medium .....                  | 4*/5**       |
| Flamethrower, LPO/RPO.....           | 2            | Night-Vision Sight (Small Arms)..... | 2            |
| Bridge, Tank-Launched .....          | 1            | Radio:                               |              |
| Ditching Machine, BTM/MDK .....      | 1            | VHF, Manpack, Low-Power.....         | 3            |
| Route-Clearing Vehicle, BAT/PKT..... | 1            | VHF, Vehicle Mount,                  |              |
| Mineclearing Plow .....              | 6*/9**       | Medium-Power .....                   | 1            |
| Mine Roller-Plow .....               | 3            |                                      |              |

**FOOTNOTES:**

- \* Equipment levels for 22-tank separate tank battalion.
- \*\* Equipment levels for 31-tank separate tank battalion.

Signal Section, Separate Tank Bn \_\_\_\_\_

|                                  |
|----------------------------------|
| <p><b>SIGNAL<br/>SECTION</b></p> |
|----------------------------------|

**PRINCIPAL ITEMS OF EQUIPMENT**

| <u>Equipment</u>                      | <u>Total</u> | <u>Equipment</u>             | <u>Total</u> |
|---------------------------------------|--------------|------------------------------|--------------|
| ACV, BTR (R-145BM)* .....             | 1            | Radios:                      |              |
| 9-mm Pistol, PM .....                 | 1            | HF, Manpack, Low-Power ..... | 1            |
| 5.45-mm Assault Rifle, AK-74 .....    | 13           | HF, Vehicle Mount,           |              |
| Truck, Utility .....                  | 1            | Medium-Power .....           | 1            |
| Van, Signal .....                     | 2            | VHF, Vehicle Mount,          |              |
| Trailer, Generator .....              | 2            | Medium-Power .....           | 1            |
| Night-Vision Sight (Small Arms) ..... | 2            | Radio Relay, VHF/UHF .....   | 2            |

*FOOTNOTE:* \* In some separate tank battalions, the tracked ACV, BMP-1KSh may replace the wheeled ACV, BTR (R-145BM).

Maintenance Section, Separate Tank Bn \_\_\_\_\_

|                                       |
|---------------------------------------|
| <p><b>MAINTENANCE<br/>SECTION</b></p> |
|---------------------------------------|

**PRINCIPAL ITEMS OF EQUIPMENT**

| <u>Equipment</u>                   | <u>Total</u> | <u>Equipment</u>                      | <u>Total</u> |
|------------------------------------|--------------|---------------------------------------|--------------|
| 9-mm Pistol, PM .....              | 1            | Trailer, Generator .....              | 1            |
| 5.45-mm Assault Rifle, AK-74 ..... | 7            | Night-Vision Sight (Small Arms) ..... | 1            |
| Armored Recovery Vehicle .....     | 2            | Radio, VHF, Vehicle Mount,            |              |
| Van, Maintenance .....             | 1            | Medium-Power .....                    | 2            |
| Truck, Crane .....                 | 1            |                                       |              |

Support Platoon, Separate Tank Bn \_\_\_\_\_

|                                   |
|-----------------------------------|
| <p><b>SUPPORT<br/>PLATOON</b></p> |
|-----------------------------------|

**PRINCIPAL ITEMS OF EQUIPMENT**

| <u>Equipment</u>                  | <u>Total</u> | <u>Equipment</u>                     | <u>Total</u> |
|-----------------------------------|--------------|--------------------------------------|--------------|
| 9-mm Pistol, PM.....              | 1            | Trailer, Cargo, 2-Axle.....          | 7            |
| 5.45-mm Assault Rifle, AK-74..... | 19           | Trailer, POL (4,200-Liter) .....     | 4*/5**       |
| Truck, Light .....                | 11           | Trailer, Water (900-Liter) .....     | 1            |
| Truck, Medium .....               | 8            | Night-Vision Sight (Small Arms)..... | 4            |
| Truck, POL (5,000-Liter).....     | 4*/5**       | Night-Vision Goggles .....           | 1            |
| Van, Kitchen .....                | 1            | Radio, VHF, Manpack, Low-Power ..... | 1            |

**FOOTNOTES:**

- \* Equipment levels for 22-tank separate tank battalion.
- \*\* Equipment levels for 31-tank separate tank battalion.

Medical Section, Separate Tank Bn \_\_\_\_\_

|                                   |
|-----------------------------------|
| <p><b>MEDICAL<br/>SECTION</b></p> |
|-----------------------------------|

**PRINCIPAL ITEMS OF EQUIPMENT**

| <u>Equipment</u>                  | <u>Total</u> | <u>Equipment</u>                     | <u>Total</u> |
|-----------------------------------|--------------|--------------------------------------|--------------|
| 5.45-mm Assault Rifle, AK-74..... | 4            | Night-Vision Goggles .....           | 1            |
| Ambulance .....                   | 1            | Radio, VHF, Manpack, Low-Power ..... | 1            |
| Trailer, Cargo, 1-Axle.....       | 1            |                                      |              |

Artillery Regiment, Mtzd Inf Div and Inf Div,  
or MD or Army or National

---

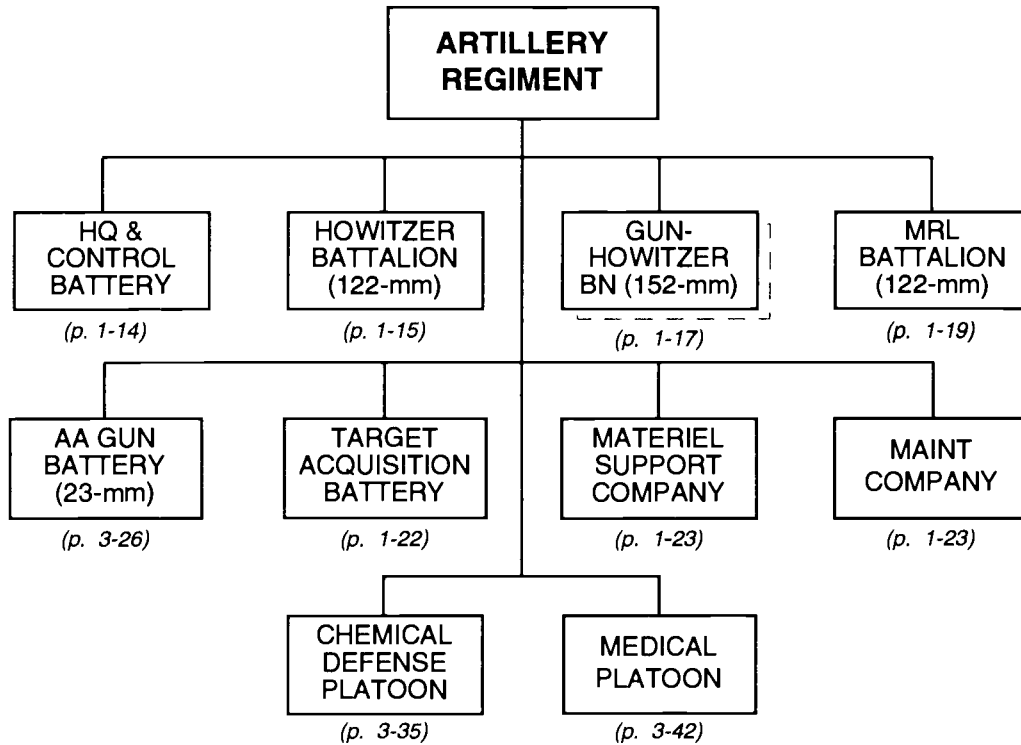

**NOTES:**

1. Divisions always have regiments with only one of each type of battalion. The equipment listing below does not include a second gun-howitzer battalion.
2. Most regiments have one of each type of battalion: howitzer, gun-howitzer, and MRL. Regiments with two 152-mm gun-howitzer battalions are more common in districts with more than three maneuver brigades.

(continued)



Artillery Regiment, Mtzd Inf Div and Inf Div,  
or MD or Army or National (continued)

| <i>Principal Items of Equipment</i>                                | <i>HQ &amp; Control Btry</i> | <i>Howitzer Bn (122-mm)</i> | <i>Howitzer Bn (152-mm)</i> | <i>MRL Bn (122-mm)</i> | <i>AA Gun Btry (23-mm)</i> | <i>Target Acquisition Btry</i> | <i>Materiel Support Co</i> | <i>Maintenance Co</i> | <i>Chemical Defense Plt</i> | <i>Medical Plt</i> | <i>TOTAL</i> |
|--|------------------------------|-----------------------------|-----------------------------|------------------------|----------------------------|--------------------------------|----------------------------|-----------------------|-----------------------------|--------------------|--------------|
| <b>ARMORED VEHICLES</b>  |                              |                             |                             |                        |                            |                                |                            |                       |                             |                    |              |
| ACV, BTR (R-145BM)   | 2                            |                             |                             |                        |                            | 1                              |                            |                       |                             |                    | 3            |
| Chemical Recon Vehicle, BRDM-2RKh                                  | 1                            |                             |                             |                        |                            |                                |                            |                       | 3                           |                    | 4            |
| APC, Radar, MT-LB (SNAR-10)*                                       |                              |                             |                             |                        |                            | 1                              |                            |                       |                             |                    | 1            |
| APC, Radar, MT-LB (ARK-1)**  |                              |                             |                             |                        |                            | 1                              |                            |                       |                             |                    | 1            |
| ACRV, 1V18 (Battery COP)   |                              | 3                           | 3                           | 3                      |                            |                                |                            |                       |                             |                    | 9            |
| ACRV, 1V19 (Battalion COP)   |                              | 1                           | 1                           | 1                      |                            |                                |                            |                       |                             |                    | 3            |
| <b>WEAPONS</b>   |                              |                             |                             |                        |                            |                                |                            |                       |                             |                    |              |
| 122-mm Howitzer, D-30  |                              | 18                          |                             |                        |                            |                                |                            |                       |                             |                    | 18           |
| 152-mm Gun Howitzer, D-20  |                              |                             | 18                          |                        |                            |                                |                            |                       |                             |                    | 18           |
| 122-mm MRL, BM-21  |                              |                             |                             | 18                     |                            |                                |                            |                       |                             |                    | 18           |
| 23-mm AA Gun, ZU-23  |                              |                             |                             |                        | 8                          |                                |                            |                       |                             |                    | 8            |
| ATGL, RPG-7V   | 4                            | 6                           | 6                           | 6                      |                            |                                |                            | 4                     |                             |                    | 26           |
| SAM, Shoulder-Fired  | 3                            | 18                          | 18                          | 18                     |                            |                                |                            |                       |                             |                    | 57           |
| <b>TRUCKS</b>  |                              |                             |                             |                        |                            |                                |                            |                       |                             |                    |              |
| ACRV, 1V110 (Battery FDC)  |                              | 3                           | 3                           | 3                      |                            |                                |                            |                       |                             |                    | 9            |
| ACRV, 1V111 (Battalion FDC)  |                              | 1                           | 1                           | 1                      |                            |                                |                            |                       |                             |                    | 3            |
| Truck, Utility   | 7                            | 1                           | 1                           | 1                      | 1                          |                                | 1                          | 1                     |                             |                    | 13           |
| Truck, Light   | 2                            | 9                           | 9                           |                        | 8                          | 3                              | 1                          |                       |                             | 1                  | 33           |
| Truck, Medium  | 1                            | 34                          | 34                          | 37                     |                            | 3                              | 32                         | 3                     |                             | 2                  | 146          |
| Truck, Decon, ARS-12U/14   |                              |                             |                             |                        |                            |                                |                            |                       | 3                           |                    | 3            |
| Truck, Decon, DDA-53/66  |                              |                             |                             |                        |                            |                                |                            |                       | 1                           | 1                  | 2            |
| Truck, Crane   |                              |                             |                             |                        |                            |                                |                            | 1                     |                             |                    | 1            |
| Truck, POL (5,000-L)   |                              | 2                           | 2                           | 3                      |                            |                                | 6                          |                       |                             |                    | 13           |
| Truck, Recovery  |                              |                             |                             |                        |                            |                                |                            | 1                     |                             |                    | 1            |
| Truck, Water (2,000-L)   |                              |                             |                             |                        |                            |                                |                            |                       | 2                           |                    | 2            |
| Van, Hospital  |                              |                             |                             |                        |                            |                                |                            |                       |                             | 1                  | 1            |
| Van, Maintenance   |                              | 1                           | 1                           | 3                      |                            | 4                              | 2                          | 6                     |                             |                    | 17           |
| Van, Signal  | 3                            | 4                           | 4                           | 4                      |                            |                                |                            |                       |                             |                    | 15           |
| Van, Survey  |                              |                             |                             |                        |                            | 1                              |                            |                       |                             |                    | 1            |
| Ambulance  |                              | 1                           | 1                           | 1                      |                            |                                |                            |                       |                             | 4                  | 7            |
| <b>TRAILERS</b>  |                              |                             |                             |                        |                            |                                |                            |                       |                             |                    |              |
| Trailer, Cargo, 1-Axle   | 1                            |                             |                             |                        |                            | 1                              |                            |                       |                             |                    | 2            |
| Trailer, Cargo, 2-Axle   |                              | 11                          | 11                          | 27                     |                            |                                | 20                         | 3                     |                             |                    | 72           |
| Trailer, Generator   | 2                            | 1                           | 1                           | 2                      |                            | 2                              |                            | 2                     |                             |                    | 10           |
| Trailer, Kitchen   | 1                            | 4                           | 4                           | 3                      |                            | 1                              |                            |                       |                             | 1                  | 14           |
| Trailer, POL (4,200-L)   |                              | 2                           | 2                           | 3                      |                            |                                | 6                          |                       |                             |                    | 13           |
| Trailer, Water (900-/1,200-L)                                      |                              | 1                           | 1                           | 1                      |                            | 1                              | 2                          |                       | 2                           | 1                  | 9            |
| Trailer, Welding   |                              |                             |                             |                        |                            |                                |                            | 1                     |                             |                    | 1            |
| <b>RADARS</b>  |                              |                             |                             |                        |                            |                                |                            |                       |                             |                    |              |
| Radar, Battlefield Surveillance, Man-Portable, PSNR-1 or TALL MIKE | 1                            | 1                           | 1                           |                        |                            | 1                              |                            |                       |                             |                    | 4            |

**FOOTNOTES:**

- \* This system includes the BIG FRED battlefield surveillance radar.
- \*\* This system includes the RICE BAG countermortar/counterbattery radar.

(continued)

Artillery Regiment, Mtzd Inf Div and Inf Div,  
or MD or Army or National (continued)

| <i>Principal Items of Equipment</i> | <i>HQ &amp; Control Btry</i> | <i>Howitzer Bn (122-mm)</i> | <i>Howitzer Bn (152-mm)</i> | <i>MRL Bn (122-mm)</i> | <i>AA Gun Btry (23-mm)</i> | <i>Target Acquisition Btry</i> | <i>Materiel Support Co</i> | <i>Maintenance Co</i> | <i>Chemical Defense Plt</i> | <i>Medical Plt</i> | <i>TOTAL</i> |
|-------------------------------------|------------------------------|-----------------------------|-----------------------------|------------------------|----------------------------|--------------------------------|----------------------------|-----------------------|-----------------------------|--------------------|--------------|
| <b>RADIOS</b>                       |                              |                             |                             |                        |                            |                                |                            |                       |                             |                    |              |
| VHF, Manpack, Low-Power             | 6                            | 14                          | 14                          | 18                     | 3                          | 13                             | 1                          | 1                     |                             | 1                  | 71           |
| VHF, Portable, Low-Power            | 1                            | 23                          | 23                          |                        |                            |                                |                            |                       |                             |                    | 47           |
| VHF, Vehicle Mount, Medium-Power    | 4                            | 8                           | 8                           | 6                      |                            | 4                              |                            |                       | 3                           |                    | 33           |
| HF, Manpack, Low-Power              | 1                            |                             |                             |                        |                            |                                |                            |                       | 1                           |                    | 2            |
| HF, Vehicle Mount, Medium-Power     | 5                            |                             |                             |                        |                            |                                |                            |                       |                             |                    | 5            |
| HF/VHF, Vehicle Mount, Med-Power    | 3                            | 4                           | 4                           | 6                      |                            |                                |                            |                       |                             |                    | 17           |
| HF/VHF, Vehicle Mount, High-Power   | 1                            |                             |                             |                        |                            |                                |                            |                       |                             |                    | 1            |
| Radio Relay, VHF/UHF                | 1                            |                             |                             |                        |                            |                                |                            |                       |                             |                    | 1            |
| Warning Receiver                    | 1                            | 1                           | 1                           | 1                      | 1                          | 1                              |                            |                       |                             |                    | 6            |
| <b>MISCELLANEOUS</b>                |                              |                             |                             |                        |                            |                                |                            |                       |                             |                    |              |
| Rangefinder, Laser, SAGE GLOSS      | 1                            | 4                           | 4                           |                        |                            | 2                              |                            |                       |                             |                    | 11           |
| Sound-Ranging Set                   |                              |                             |                             |                        |                            | 1                              |                            |                       |                             |                    | 1            |

Headquarters and Control Battery, Arty Regt or  
Arty Bde or MRL Bde

---

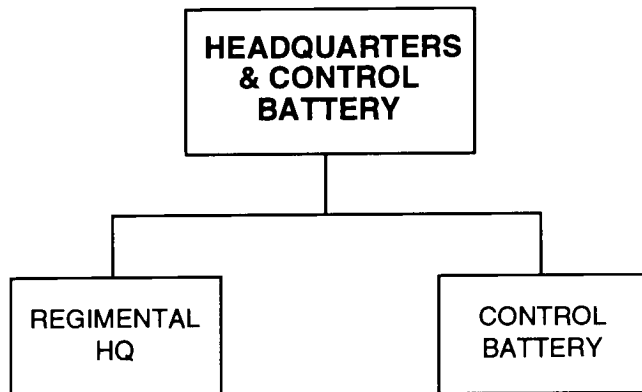

**PRINCIPAL ITEMS OF EQUIPMENT**

| <u>Equipment</u>                      | <u>Total</u> | <u>Equipment</u>             | <u>Total</u> |
|---------------------------------------|--------------|------------------------------|--------------|
| SAM, Shoulder-Fired.....              | 3            | Radios:                      |              |
| ATGL, RPG-7V.....                     | 4            | VHF, Manpack, Low-Power..... | 6            |
| ACV, BTR (R-145BM).....               | 2            | VHF, Portable, Low-Power or  |              |
| Truck, Utility.....                   | 7            | Very-Low-Power.....          | 1            |
| Truck, Light.....                     | 2            | VHF, Vehicle Mount,          |              |
| Truck, Medium.....                    | 1            | Medium-Power.....            | 4            |
| Chemical Recon Vehicle,               |              | HF/VHF, Vehicle Mount,       |              |
| BRDM-2RKh.....                        | 1            | Medium-Power.....            | 3            |
| Van, Signal.....                      | 3            | HF/VHF, Vehicle Mount,       |              |
| Trailer, Cargo, 1-Axle.....           | 1            | High-Power.....              | 1            |
| Trailer, Generator.....               | 2            | HF, Manpack, Low-Power.....  | 1            |
| Trailer, Kitchen.....                 | 1            | HF, Vehicle Mount,           |              |
| Rangefinder, Laser, SAGE GLOSS.....   | 1            | Medium-Power.....            | 5            |
| Radar, Battlefield Surveillance, Man- |              | Radio Relay, VHF/UHF.....    | 1            |
| Portable, PSNR-1 or TALL MIKE.....    | 1            | Warning Receiver.....        | 1            |

**122-mm Howitzer Battalion, Mtzd Inf Bde (Sep)  
and Inf Bde (Sep), or Arty Regt**

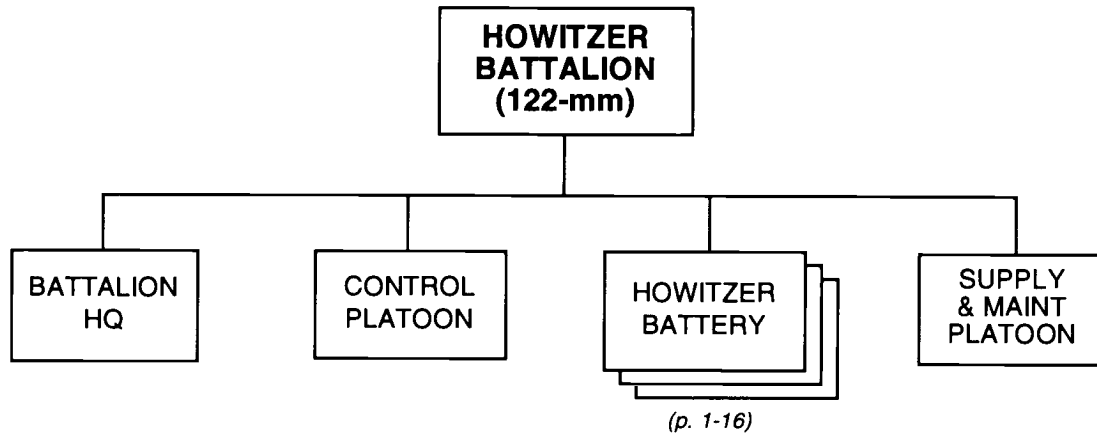

**PRINCIPAL ITEMS OF EQUIPMENT**

| <u>Equipment</u>                  | <u>Total</u> | <u>Equipment</u>   | <u>Total</u> |
|-----------------------------------|--------------|--|--------------|
| 122-mm Howitzer, D-30.....        | 18           | Trailer, Generator.....  | 1            |
| ACRV, 1V110 (Battery FDC) .....   | 3            | Trailer, Kitchen.....  | 4            |
| ACRV, 1V18 (Battery COP) .....    | 3            | Trailer, POL (4,200-Liter) .....   | 2            |
| ACRV, 1V19 (Battalion COP) .....  | 1            | Trailer, Water (900-Liter) .....   | 1            |
| ACRV, 1V111 (Battalion FDC) ..... | 1            | Rangefinder, Laser, SAGE GLOSS .....   | 4            |
| SAM, Shoulder-Fired.....          | 18           | Radar, Battlefield Surveillance, Man-<br>Portable, PSNR-1 or TALL MIKE ..... | 1            |
| ATGL, RPG-7V.....                 | 6            | Radios:  |              |
| 7.62-mm GP MG, PKM.....           | 18           | VHF, Manpack, Low-Power .....  | 14           |
| Truck, Utility .....              | 1            | VHF, Portable, Low-Power<br>or Very-Low-Power .....                          | 23           |
| Truck, Light .....                | 9            | VHF, Vehicle Mount,<br>Medium-Power .....                                    | 8            |
| Truck, Medium .....               | 34           | HF/VHF, Vehicle Mount,<br>Medium-Power .....                                 | 4            |
| Truck, POL (5,000-Liter).....     | 2            | Warning Receiver .....   | 1            |
| Van, Maintenance .....            | 1            |  |              |
| Van, Signal.....                  | 4            |  |              |
| Ambulance .....                   | 1            |  |              |
| Trailer, Cargo, 2-Axle.....       | 11           |  |              |

122-mm Howitzer Battery,  
122-mm Howitzer Bn

---

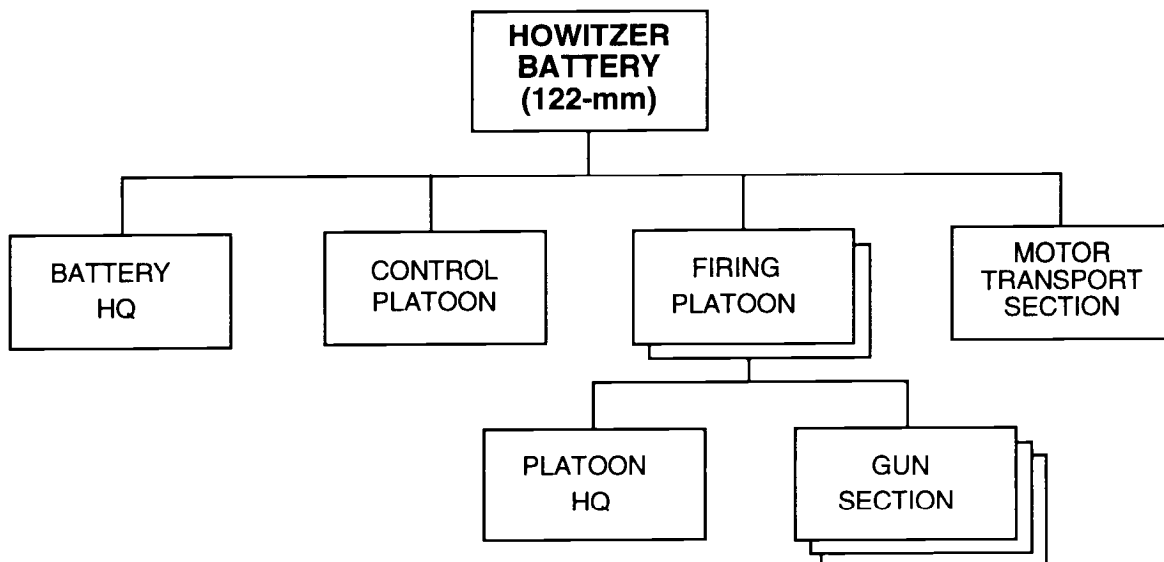

**PRINCIPAL ITEMS OF EQUIPMENT**

| <u>Equipment</u>                | <u>Total</u> | <u>Equipment</u>                     | <u>Total</u> |
|---------------------------------|--------------|--------------------------------------|--------------|
| 122-mm Howitzer, D-30.....      | 6            | Rangefinder, Laser, SAGE GLOSS ..... | 1            |
| ACRV, 1V110 (Battery FDC) ..... | 1            | Radios:                              |              |
| ACRV, 1V18 (Battery COP) .....  | 1            | VHF, Manpack, Low-Power .....        | 2            |
| SAM, Shoulder-Fired.....        | 6            | VHF, Portable,                       |              |
| ATGL, RPG-7V .....              | 2            | Very-Low-Power .....                 | 7            |
| 7.62-mm GP MG, PKM.....         | 6            | VHF, Vehicle Mount,                  |              |
| Truck, Medium .....             | 8            | Medium-Power .....                   | 2            |
| Van, Signal.....                | 1            | HF/VHF, Vehicle Mount,               |              |
| Trailer, Cargo, 2-Axle.....     | 1            | Medium-Power .....                   | 1            |

152-mm Gun-Howitzer Battalion,  
Arty Regt or Arty Bde \_\_\_\_\_

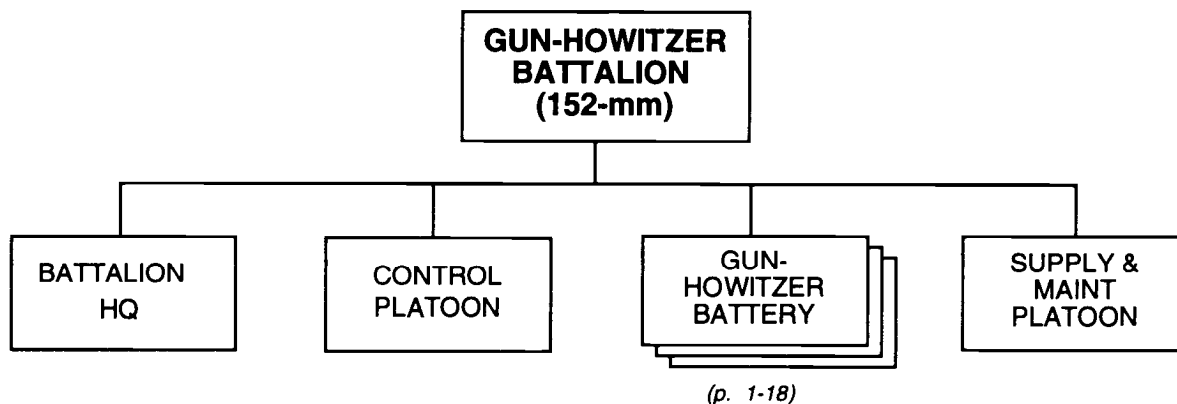

**PRINCIPAL ITEMS OF EQUIPMENT**

| <u>Equipment</u>                  | <u>Total</u> | <u>Equipment</u>   | <u>Total</u> |
|-----------------------------------|--------------|--|--------------|
| 152-mm Gun-Howitzer, D-20.....    | 18           | Trailer, Generator.....  | 1            |
| ACRV, 1V110 (Battery FDC) .....   | 3            | Trailer, Kitchen.....  | 4            |
| ACRV, 1V18 (Battery COP) .....    | 3            | Trailer, POL (4,200-Liter) .....   | 2            |
| ACRV, 1V19 (Battalion COP) .....  | 1            | Trailer, Water (900-Liter) .....   | 1            |
| ACRV, 1V111 (Battalion FDC) ..... | 1            | Rangefinder, Laser, SAGE GLOSS .....   | 4            |
| SAM, Shoulder-Fired.....          | 18           | Radar, Battlefield Surveillance, Man-<br>Portable, PSNR-1 or TALL MIKE ..... | 1            |
| ATGL, RPG-7V .....                | 6            | Radios:  |              |
| 7.62-mm GP MG, PKM.....           | 18           | VHF, Manpack, Low-Power.....   | 14           |
| Truck, Utility .....              | 1            | VHF, Portable, Low-Power<br>or Very-Low-Power .....                          | 23           |
| Truck, Light .....                | 9            | VHF, Vehicle Mount,<br>Medium-Power .....                                    | 8            |
| Truck, Medium .....               | 34           | HF/VHF, Vehicle Mount,<br>Medium-Power .....                                 |              |
| Truck, POL (5,000-Liter).....     | 2            | Warning Receiver .....   | 1            |
| Van, Maintenance .....            | 1            |  |              |
| Van, Signal.....                  | 4            |  |              |
| Ambulance .....                   | 1            |  |              |
| Trailer, Cargo, 2-Axle.....       | 11           |  |              |

152-mm Gun-Howitzer Battery,  
152-mm Gun-Howitzer Bn

---

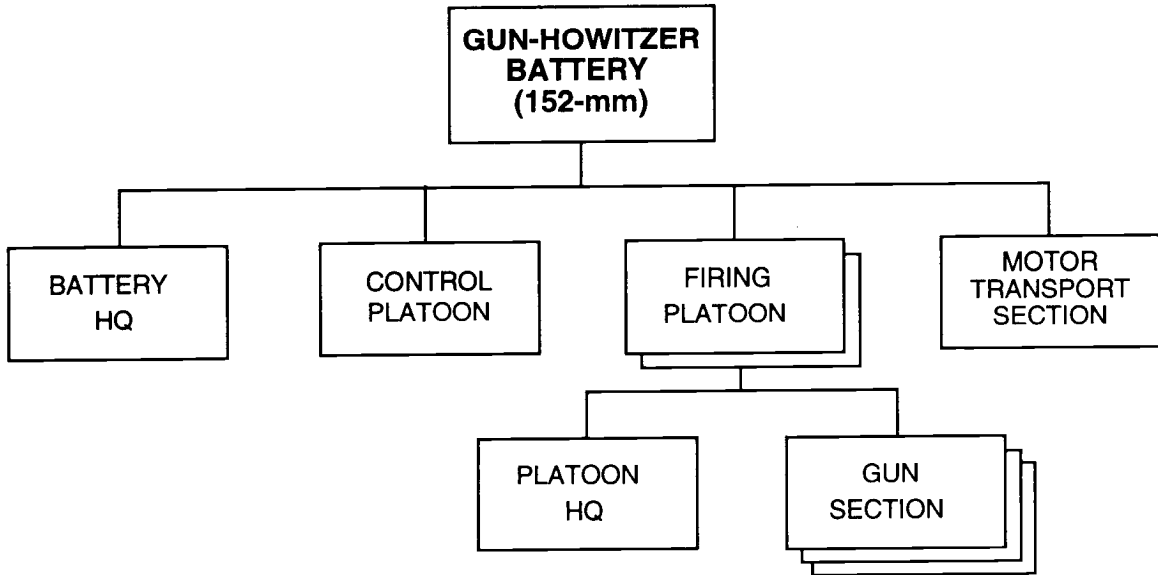

**PRINCIPAL ITEMS OF EQUIPMENT**

| <u>Equipment</u>                | <u>Total</u> |
|---------------------------------|--------------|
| 152-mm Gun-Howitzer, D-20.....  | 6            |
| ACRV, 1V110 (Battery FDC) ..... | 1            |
| ACRV, 1V18 (Battery COP) .....  | 1            |
| SAM, Shoulder-Fired.....        | 6            |
| ATGL, RPG-7V .....              | 2            |
| 7.62-mm GP MG, PKM.....         | 6            |
| Truck, Medium .....             | 8            |
| Van, Signal.....                | 1            |
| Trailer, Cargo, 2-Axle.....     | 1            |

| <u>Equipment</u>                             | <u>Total</u> |
|--|--------------|
| Rangefinder, Laser, SAGE GLOSS .....         | 1            |
| Radios:                                      |              |
| VHF, Manpack, Low-Power .....                | 2            |
| VHF, Portable, Very-Low-Power .....          | 7            |
| VHF, Vehicle Mount,<br>Medium-Power .....    | 2            |
| HF/VHF, Vehicle Mount,<br>Medium-Power ..... | 1            |

**122-mm Multiple Rocket Launcher Battalion, Arty Regt  
and SP Arty Regt, or MRL Bde**

---

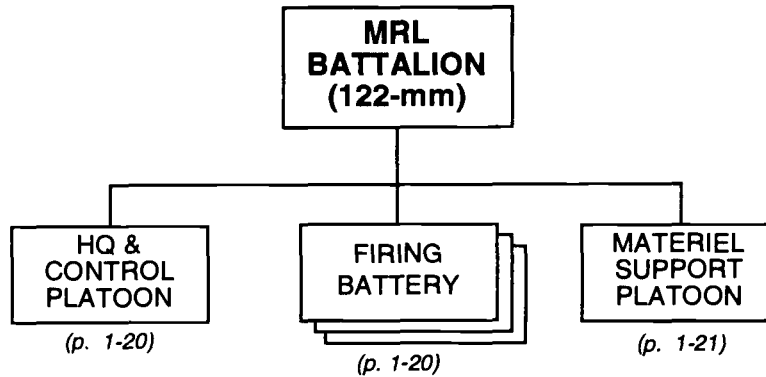

**PRINCIPAL ITEMS OF EQUIPMENT**

| <u>Equipment</u>                 | <u>Total</u> | <u>Equipment</u>                  | <u>Total</u> |
|----------------------------------|--------------|-----------------------------------|--------------|
| 122-mm MRL, BM-21.....           | 18           | Trailer, Cargo, 2-Axle.....       | 27           |
| ACRV, 1V110 (Battery FDC).....   | 3            | Trailer, Generator.....           | 2            |
| ACRV, 1V18 (Battery COP).....    | 3            | Trailer, Kitchen.....             | 3            |
| ACRV, 1V19 (Battalion COP).....  | 1            | Trailer, POL (4,200-Liter).....   | 3            |
| ACRV, 1V111 (Battalion FDC)..... | 1            | Trailer, Water (1,200-Liter)..... | 1            |
| SAM, Shoulder-Fired.....         | 18           | Radios:                           |              |
| ATGL, RPG-7V.....                | 6            | VHF, Manpack, Low-Power.....      | 18           |
| Truck, Utility.....              | 1            | VHF, Vehicle Mount,               |              |
| Truck, Medium.....               | 37           | Medium-Power.....                 | 6            |
| Truck, POL (5,000-Liter).....    | 3            | HF/VHF, Vehicle Mount,            |              |
| Van, Maintenance.....            | 3            | Medium-Power.....                 | 6            |
| Van, Signal.....                 | 4            | Warning Receiver.....             | 1            |
| Ambulance.....                   | 1            |                                   |              |



Headquarters and Control Platoon, 122-mm MRL Bn

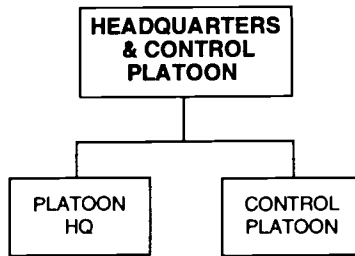

PRINCIPAL ITEMS OF EQUIPMENT

| <u>Equipment</u>                  | <u>Total</u> | <u>Equipment</u>              | <u>Total</u> |
|-----------------------------------|--------------|-------------------------------|--------------|
| ACRV, 1V19 (Battalion COP) .....  | 1            | Trailer, Generator .....      | 1            |
| ACRV, 1V111 (Battalion FDC) ..... | 1            | Radios:                       |              |
| Truck, Utility .....              | 1            | VHF, Manpack, Low-Power ..... | 5            |
| Truck, Medium .....               | 1            | HF/VHF, Vehicle Mount,        |              |
| Van, Signal .....                 | 1            | Medium-Power .....            | 3            |
| Ambulance .....                   | 1            | Warning Receiver .....        | 1            |

Firing Battery, 122-mm MRL Bn

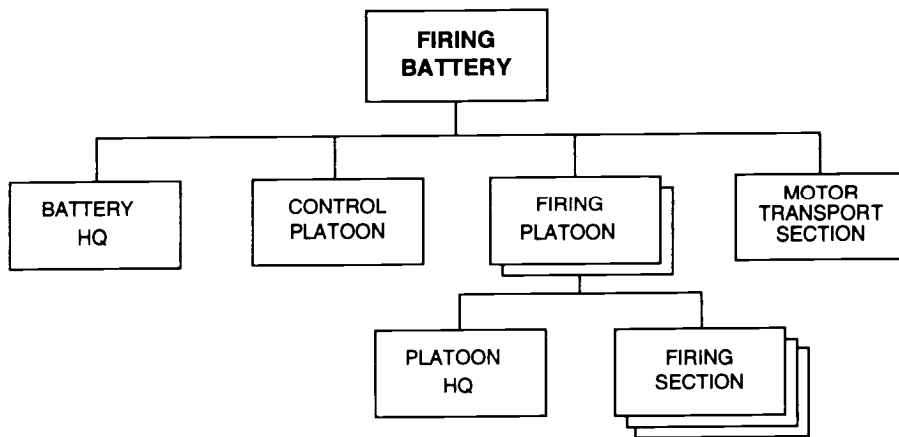

PRINCIPAL ITEMS OF EQUIPMENT

| <u>Equipment</u>                | <u>Total</u> | <u>Equipment</u>              | <u>Total</u> |
|---------------------------------|--------------|-------------------------------|--------------|
| 122-mm MRL, BM-21 .....         | 6            | Trailer, Cargo, 2-Axle .....  | 3            |
| ACRV, 1V110 (Battery FDC) ..... | 1            | Radio:                        |              |
| ACRV, 1V18 (Battery COP) .....  | 1            | VHF, Manpack, Low-Power ..... | 4            |
| SAM, Shoulder-Fired .....       | 6            | VHF, Vehicle Mount,           |              |
| ATGL, RPG-7V .....              | 2            | Medium-Power .....            | 2            |
| Truck, Medium .....             | 6            | HF/VHF, Vehicle Mount,        |              |
| Van, Signal .....               | 1            | Medium-Power .....            | 1            |

**Matériel Support Platoon, 122-mm MRL Bn**

---

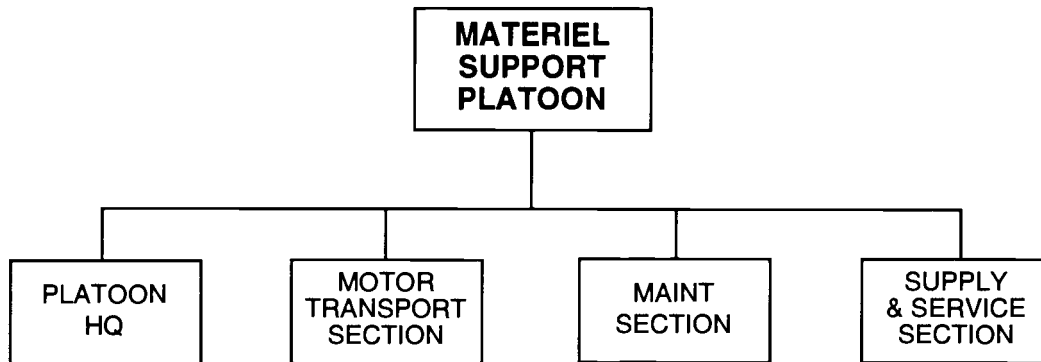

**PRINCIPAL ITEMS OF EQUIPMENT**

| <u>Equipment</u>              | <u>Total</u> | <u>Equipment</u>                     | <u>Total</u> |
|-------------------------------|--------------|--------------------------------------|--------------|
| Truck, Medium .....           | 18           | Trailer, Kitchen .....               | 3            |
| Truck, POL (5,000-Liter)..... | 3            | Trailer, POL (4,200-Liter) .....     | 3            |
| Van, Maintenance .....        | 3            | Trailer, Water (1,200-Liter) .....   | 1            |
| Trailer, Cargo, 2-Axle.....   | 18           | Radio, VHF, Manpack, Low-Power ..... | 1            |
| Trailer, Generator.....       | 1            |                                      |              |

Target Acquisition Battery, Arty Regt  
or Arty Bde or MRL Bde

---

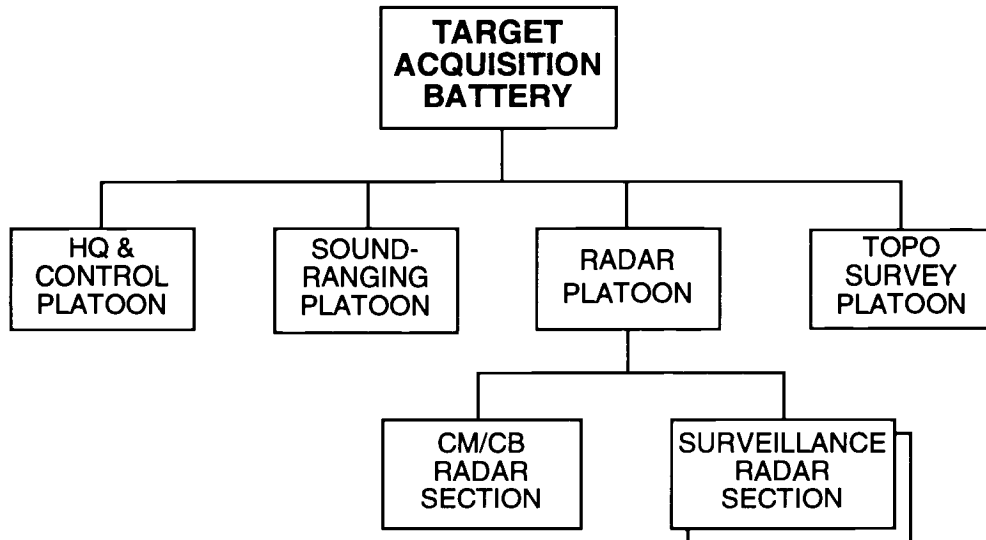

**PRINCIPAL ITEMS OF EQUIPMENT**

| <u>Equipment</u>                   | <u>Total</u> | <u>Equipment</u>   | <u>Total</u> |
|------------------------------------|--------------|--|--------------|
| ACV, BTR (R-145BM) .....           | 1            | Trailer, Water (900-Liter) .....   | 1            |
| APC, Radar, MT-LB (SNAR 10)* ..... | 1            | Rangefinder, Laser, SAGE GLOSS .....   | 2            |
| APC, Radar, MT-LB (ARK-1)** .....  | 1            | Sound-Ranging Set .....  | 1            |
| Truck, Light .....                 | 3            | Radar, Battlefield Surveillance, Man-<br>Portable, PSNR-1 or TALL MIKE ..... | 1            |
| Truck, Medium .....                | 3            | Radios:  |              |
| Van, Maintenance .....             | 4            | VHF, Manpack, Low-Power .....  | 13           |
| Van, Survey .....                  | 1            | VHF, Vehicle Mount,<br>Medium-Power .....                                    | 4            |
| Trailer, Cargo, 1-Axle .....       | 1            | Warning Receiver .....   | 1            |
| Trailer, Generator .....           | 2            |  |              |
| Trailer, Kitchen .....             | 1            |  |              |

**FOOTNOTES:**

- \* This system includes the BIG FRED battlefield surveillance radar.
- \*\* This system includes the RICE BAG countermortar/counterbattery radar.

**Materiel Support Company, Arty Regt and SP Arty Regt,  
or Arty Bde or MRL Bde**

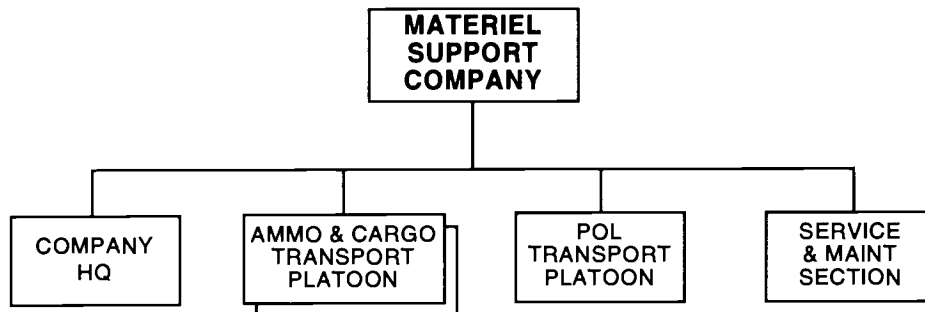

**PRINCIPAL ITEMS OF EQUIPMENT**

| <u>Equipment</u>              | <u>Total</u> | <u>Equipment</u>                     | <u>Total</u> |
|-------------------------------|--------------|--------------------------------------|--------------|
| Truck, Utility .....          | 1            | Trailer, Cargo, 2-Axle.....          | 20           |
| Truck, Light .....            | 1            | Trailer, POL (4,200-Liter) .....     | 6            |
| Truck, Medium .....           | 32           | Trailer, Water (1,200-Liter) .....   | 2            |
| Truck, POL (5,000-Liter)..... | 6            | Radio, VHF, Manpack, Low-Power ..... | 1            |
| Van, Maintenance .....        | 2            |                                      |              |

**Maintenance Company, Arty Regt and SP Arty Regt,  
or Arty Bde or MRL Bde**

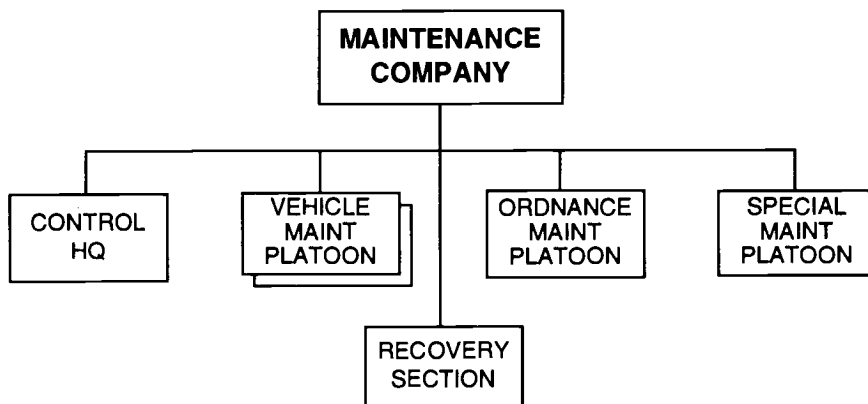

**PRINCIPAL ITEMS OF EQUIPMENT**

| <u>Equipment</u>          | <u>Total</u> | <u>Equipment</u>                     | <u>Total</u> |
|---------------------------|--------------|--------------------------------------|--------------|
| ATGL, RPG-7V.....         | 4            | Van, Maintenance .....               | 6            |
| 5.45-mm LMG, RPK-74 ..... | 2            | Trailer, Cargo, 2-Axle.....          | 3            |
| Truck, Utility .....      | 1            | Trailer, Generator.....              | 2            |
| Truck, Medium .....       | 3            | Trailer, Welding.....                | 1            |
| Truck, Crane .....        | 1            | Radio, VHF, Manpack, Low-Power ..... | 1            |
| Truck, Recovery .....     | 1            |                                      |              |

**Antiaircraft Gun Regiment (57-mm), Mtzd Inf Div and Inf Div, and Mech Inf Div,  
or MD or Army or ADC**

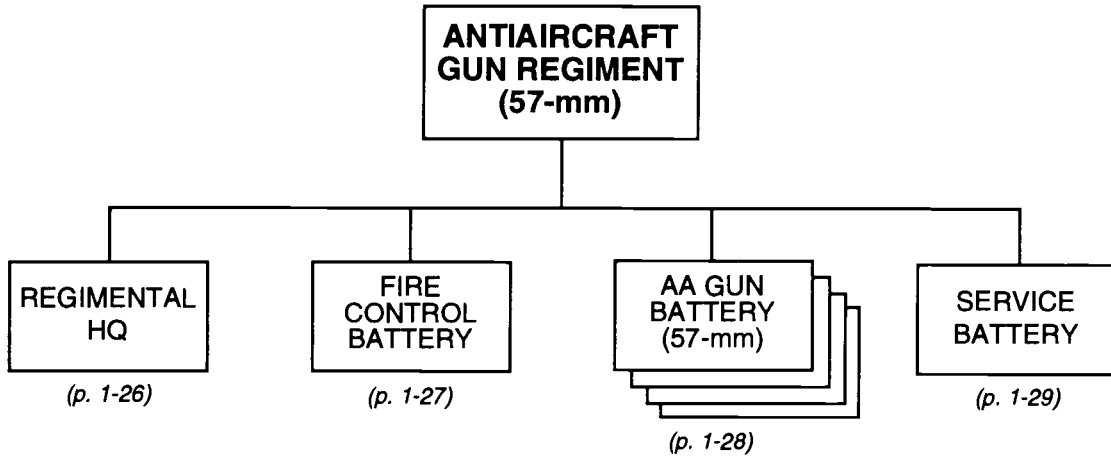

**NOTE:** Some AA gun regiments at army level or in the Air Defense Command (ADC) may have the 100-mm AA gun, KS-19. Regiments so equipped may have the organization shown above or have three battalions, each with three firing batteries. In this organization, regimental total KS- 19 would be 54 systems.

**(continued)**

Antiaircraft Gun Regiment (57-mm), Mtzd Inf Div and  
Inf Div, or Army or ADC (continued)

| <i>Principal Items of<br/>Equipment</i> | <i>Regimental HQ</i> | <i>Fire Control Btry</i> | <i>AA Gun Btry (57-mm) (4x)</i> | <i>Service Btry</i> | <i>TOTAL</i> |
|---|----------------------|--------------------------|---------------------------------|---------------------|--------------|
| <b>ARMORED VEHICLES</b>                 |                      |                          |                                 |                     |              |
| APC, BTR-60 (PU-12)                     | 2                    |                          |                                 |                     | 2            |
| <b>WEAPONS</b>                          |                      |                          |                                 |                     |              |
| 57-mm AA Gun, S-60                      |                      |                          | 24                              |                     | 24           |
| SAM, Shoulder-Fired                     | 3                    |                          | 12                              |                     | 15           |
| <b>TRUCKS</b>                           |                      |                          |                                 |                     |              |
| Truck, Utility                          | 1                    | 3                        | 4                               | 2                   | 10           |
| Truck, Light                            | 3                    |                          | 4                               |                     | 7            |
| Truck, Medium                           |                      |                          | 36                              | 33                  | 69           |
| Truck, Chemical Recon, UAZ-69RKh        |                      | 1                        |                                 |                     | 1            |
| Truck, Crane                            |                      |                          |                                 | 1                   | 1            |
| Truck, POL (5,000-L)                    |                      |                          | 4                               | 2                   | 6            |
| Truck, Water (2,000-L)                  |                      |                          |                                 | 1                   | 1            |
| Van, Maintenance                        |                      |                          |                                 | 4                   | 4            |
| Van, Radar                              |                      | 2                        | 4                               |                     | 6            |
| Van, Signal                             | 2                    | 1                        |                                 |                     | 3            |
| Ambulance                               | 1                    |                          |                                 |                     | 1            |
| <b>TRAILERS</b>                         |                      |                          |                                 |                     |              |
| Trailer, Cargo, 2-Axle                  |                      |                          |                                 | 5                   | 5            |
| Trailer, Generator                      | 1                    | 1                        | 4                               | 2                   | 8            |
| Trailer, Kitchen                        | 1                    |                          | 4                               | 3                   | 8            |
| Trailer, POL (1,200-L)                  |                      |                          | 4                               |                     | 4            |
| Trailer, POL (4,200-L)                  |                      |                          |                                 | 2                   | 2            |
| Trailer, Water (900-/1,200-L)           |                      |                          | 4                               | 3                   | 7            |
| <b>RADARS</b>                           |                      |                          |                                 |                     |              |
| Aer. Surv./Tgt Acq, FLAT FACE           |                      | 2                        |                                 |                     | 2            |
| Radar, Fire Control, FLAP WHEEL         |                      |                          | 4                               |                     | 4            |
| <b>RADIOS</b>                           |                      |                          |                                 |                     |              |
| VHF, Manpack, Low-Power                 | 1                    | 1                        | 18                              | 2                   | 22           |
| VHF, Portable, Very-Low-Power           | 1                    | 1                        | 12                              |                     | 14           |
| VHF, Vehicle Mount, Medium-Power        | 2                    |                          |                                 |                     | 2            |
| HF, Manpack, Low-Power                  |                      |                          |                                 | 1                   | 1            |
| HF, Vehicle Mount, Medium-Power         | 2                    |                          |                                 |                     | 2            |
| HF/VHF, Vehicle Mount, Med-Power        | 1                    | 1                        |                                 |                     | 2            |
| HF/VHF, Vehicle Mount, High-Power       | 1                    | 1                        |                                 |                     | 2            |
| Radio Relay, VHF/UHF                    | 1                    |                          |                                 |                     | 1            |
| Warning Receiver                        | 1                    |                          | 4                               |                     | 5            |

**Regimental Headquarters,  
AA Gun Regt (57-mm)**

---

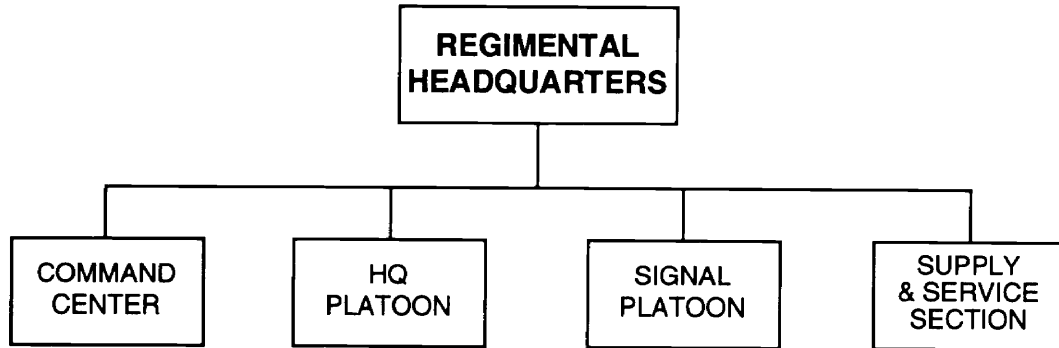

**PRINCIPAL ITEMS OF EQUIPMENT**

| <u>Equipment</u>                    | <u>Total</u> |
|-------------------------------------|--------------|
| SAM, Shoulder-Fired.....            | 3            |
| ACV, BTR-60 (PU-12).....            | 2            |
| Truck, Utility .....                | 1            |
| Truck, Light .....                  | 3            |
| Van, Signal.....                    | 2            |
| Ambulance .....                     | 1            |
| Trailer, Generator.....             | 1            |
| Trailer, Kitchen.....               | 1            |
| Radios:                             |              |
| VHF, Manpack, Low-Power .....       | 1            |
| VHF, Portable, Very-Low-Power ..... | 1            |

| <u>Equipment</u>                             | <u>Total</u> |
|--|--------------|
| VHF, Vehicle Mount,<br>Medium-Power .....    | 2            |
| HF, Vehicle Mount,<br>Medium-Power .....     | 2            |
| HF/VHF, Vehicle Mount,<br>Medium-Power ..... | 1            |
| HF/VHF, Vehicle Mount,<br>High-Power .....   | 1            |
| Radio Relay, VHF/UHF.....                    | 1            |
| Warning Receiver .....                       | 1            |

Fire Control Battery, AA Gun Regt (57-mm)

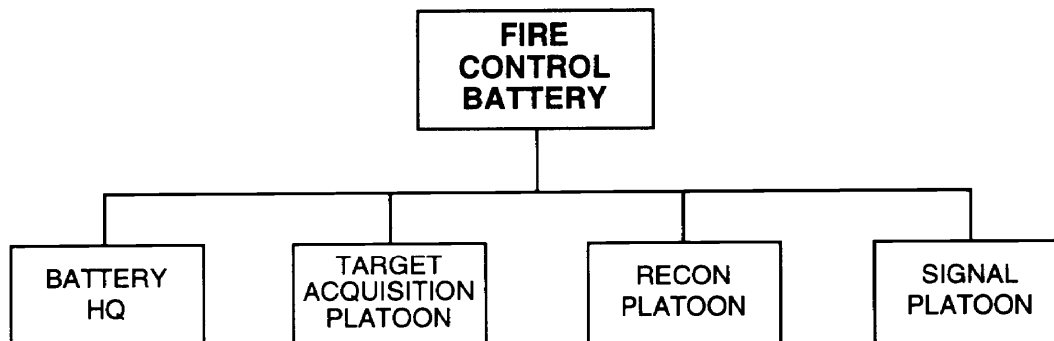

PRINCIPAL ITEMS OF EQUIPMENT

| <u>Equipment</u>                       | <u>Total</u> | <u>Equipment</u>              | <u>Total</u> |
|--|--------------|-------------------------------|--------------|
| Truck, Utility .....                   | 3            | Radios:                       |              |
| Truck, Chemical Recon, UAZ-69RKh ..... | 1            | VHF, Manpack, Low-Power ..... | 1            |
| Van, Radar .....                       | 2            | HF/VHF, Vehicle Mount,        |              |
| Van, Signal.....                       | 1            | Medium-Power .....            | 1            |
| Trailer, Generator.....                | 1            | HF/VHF, Vehicle Mount,        |              |
| Radar, Aerial Surveillance/Target      |              | High-Power .....              | 1            |
| Acquisition, FLAT FACE.....            | 2            |                               |              |



Antiaircraft Gun Battery (57-mm), AA Gun Regt (57-mm)  
or AA Gun Bn (57-mm) or AA Gun Bn (Mixed)

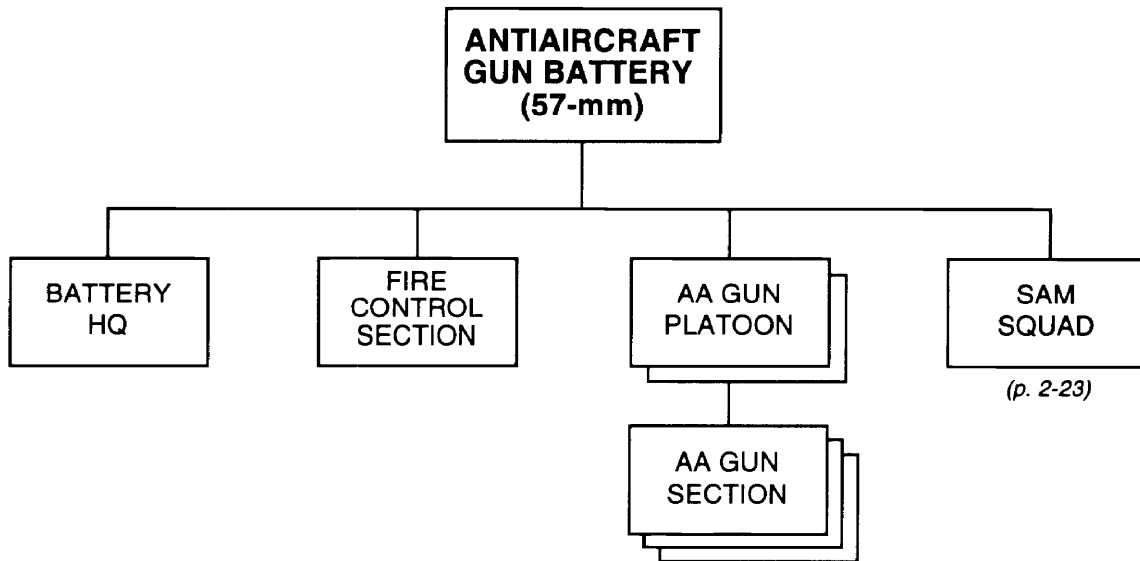

PRINCIPAL ITEMS OF EQUIPMENT

| <u>Equipment</u>              | <u>Total</u> | <u>Equipment</u>                      | <u>Total</u> |
|-------------------------------|--------------|---------------------------------------|--------------|
| 57-mm AA Gun, S-60.....       | 6            | Trailer, Kitchen.....                 | 1            |
| SAM, Shoulder-Fired.....      | 3            | Trailer, POL (1,200-Liter) .....      | 1            |
| Truck, Utility .....          | 1            | Trailer, Water (900-Liter) .....      | 1            |
| Truck, Light .....            | 1            | Radar, Fire Control, FLAP WHEEL*..... | 1            |
| Truck, Medium .....           | 9            | Radios:                               |              |
| Truck, POL (5,000-Liter)..... | 1            | VHF, Manpack, Low-Power .....         | 6            |
| Van, Radar* .....             | 1            | VHF, Portable, Very-Low-Power .....   | 3            |
| Trailer, Generator.....       | 1            | Warning Receiver .....                | 1            |

**FOOTNOTE:** \* Some units may have the older FIRE CAN fire control radar and the PUAZO-6 fire control director with an optical rangefinder. In that case the battery would have two additional medium trucks as prime movers for this combination of towed fire control systems, but it does not have the truck-mounted FLAP WHEEL radar van.

Service Battery, AA Gun Regt (57-mm)

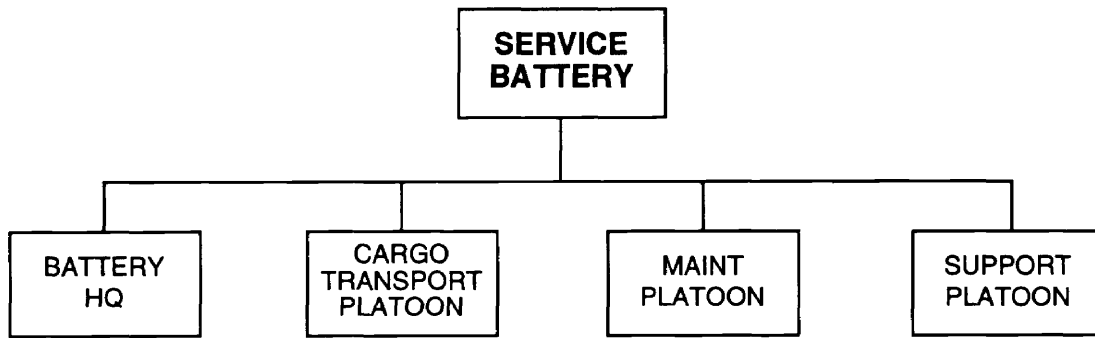

**PRINCIPAL ITEMS OF EQUIPMENT**

| <u>Equipment</u>                 | <u>Total</u> | <u>Equipment</u>                   | <u>Total</u> |
|----------------------------------|--------------|------------------------------------|--------------|
| Truck, Utility .....             | 2            | Trailer, Generator.....            | 2            |
| Truck, Medium .....              | 33           | Trailer, Kitchen.....              | 3            |
| Truck, Crane .....               | 1            | Trailer, POL (4,200-Liter) .....   | 2            |
| Truck, POL (5,000-Liter).....    | 2            | Trailer, Water (1,200-Liter) ..... | 3            |
| Truck, Water (2,000-Liter) ..... | 1            | Radios:                            |              |
| Van, Maintenance .....           | 4            | VHF, Manpack, Low-Power.....       | 2            |
| Trailer, Cargo, 2-Axle.....      | 5            | HF, Manpack, Low-Power.....        | 1            |

Antitank Battalion (Standard), Mtzd Inf Div  
or MD or Army or National

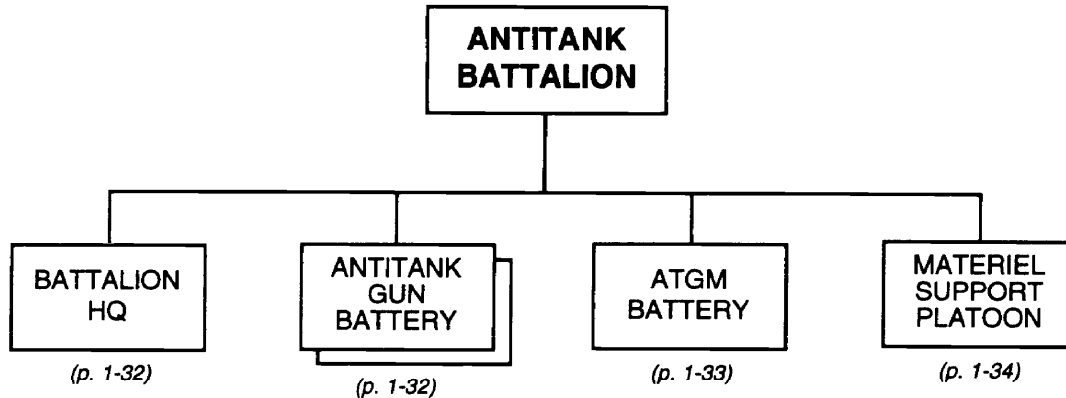

**PRINCIPAL ITEMS OF EQUIPMENT**

| <u>Equipment</u>   | <u>Total</u> | <u>Equipment</u>  | <u>Total</u> |
|--|--------------|---|--------------|
| ATGM Vehicle, 9P133,<br>w/AT-3/SAGGER or 9P148,<br>w/AT-5/SPANDREL ..... | 9            | Trailer, Kitchen .....  | 1            |
| 100-mm Antitank Gun, T-12/MT-12 .....                                    | 12           | Trailer, POL (4,200-Liter) .....  | 1            |
| ATGL, RPG-7V .....   | 9            | Trailer, Water (900-Liter) .....  | 1            |
| ACV, BTR (R-145BM)/BRDM-2U .....   | 1            | Rangefinder, Stereoscopic, DS-1 .....   | 3            |
| ACV, BRDM-2U .....   | 4            | Radar, Battlefield Surveillance, Man-<br>Portable, PSNR-1, or TALL MIKE ..... | 4            |
| Truck, Utility .....   | 3            | Radios:   |              |
| Truck, Light .....   | 4            | VHF, Manpack, Low-Power .....   | 10           |
| Truck, Medium .....  | 26           | VHF, Vehicle Mount,<br>Medium-Power .....                                     | 28           |
| Truck, POL (5,000-Liter) .....   | 3            | HF/VHF, Vehicle Mount,<br>Medium-Power .....                                  | 3            |
| Van, Maintenance .....   | 2            | HF, Vehicle Mount,<br>Medium-Power .....                                      | 1            |
| Van, Signal .....  | 2            | Radio Relay, VHF/UHF .....  | 1            |
| Ambulance .....  | 1            | Warning Receiver .....  | 1            |
| Trailer, Cargo, 2-Axle .....   | 10           |   |              |
| Trailer, Generator .....   | 1            |   |              |

**NOTES:**

1. Some antitank units from the national asset pool have three antitank gun batteries instead of two antitank gun batteries and one ATGM battery. An army, region, district, or division may receive such a battalion, known as an antitank gun battalion. (See p. 1-31.)
2. Separate mechanized infantry brigades and well-equipped districts can have either the battalion as depicted above or a battalion composed entirely of ATGM batteries, in which case it will be called an ATGM battalion (see p. 2-26). During force modernization, the tendency is for districts/brigades with offensive contingency missions to have an ATGM battalion, whereas districts/brigades with primarily defensive contingency missions have the standard antitank battalion.

Antitank Gun Battalion, Mtzd Inf Div and Inf Div,  
or MD or Army or National \_\_\_\_\_

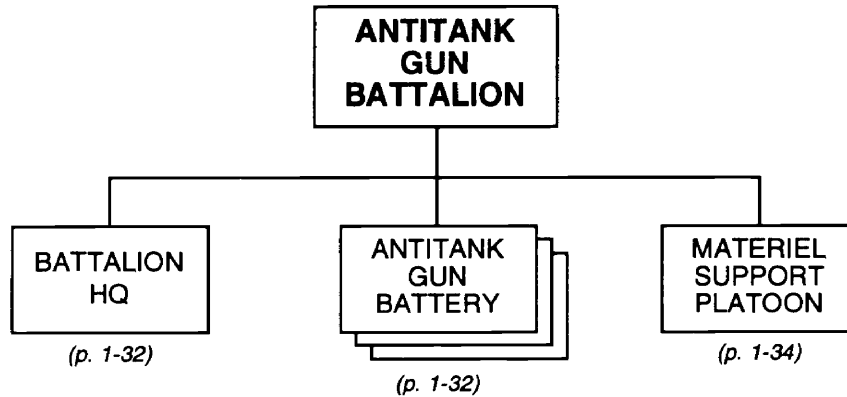

**PRINCIPAL ITEMS OF EQUIPMENT**

| <u>Equipment</u>                     | <u>Total</u> | <u>Equipment</u>                            | <u>Total</u> |
|--------------------------------------|--------------|---|--------------|
| 100-mm Antitank Gun, T-12/MT-12..... | 18           | Rangefinder, Stereoscopic, DS-1 .....       | 3            |
| ACV, BTR (R-145BM)/BRDM-2U .....     | 1            | Radar, Battlefield Surveillance, Man- ..... |              |
| Truck, Utility .....                 | 3            | Portable, PSNR-1, or TALL MIKE .....        | 4            |
| Truck, Light .....                   | 4            | Radios:                                     |              |
| Truck, Medium .....                  | 31           | VHF, Manpack, Low-Power .....               | 7            |
| Truck, POL (5,000-Liter).....        | 3            | VHF, Vehicle Mount,                         |              |
| Van, Maintenance .....               | 2            | Medium-Power .....                          | 22           |
| Van, Signal.....                     | 2            | HF/VHF, Vehicle Mount,                      |              |
| Ambulance .....                      | 1            | Medium-Power .....                          | 3            |
| Trailer, Cargo, 2-Axle.....          | 11           | HF, Vehicle Mount,                          |              |
| Trailer, Generator.....              | 1            | Medium-Power .....                          | 1            |
| Trailer, Kitchen .....               | 1            | Radio Relay, VHF/UHF.....                   | 1            |
| Trailer, POL (4,200-Liter) .....     | 3            | Warning Receiver .....                      | 1            |
| Trailer, Water (900-Liter) .....     | 1            |   |              |

**NOTES:**

1. Some antitank units from the national asset pool are antitank gun battalions. They have three antitank gun batteries instead of two and one ATGM battery of a standard antitank battalion (see p. 1-30).
2. The General Staff can allocate an antitank gun battalion to an army or military region. In turn, the army or region can allocate such a battalion to a division or district expecting the greatest armor threat.

**Battalion Headquarters, Antitank Bn (Standard)  
or Antitank Gun Bn or ATGM Bn**

---



**PRINCIPAL ITEMS OF EQUIPMENT**

| <u>Equipment</u>   | <u>Total</u> | <u>Equipment</u>                             | <u>Total</u> |
|--|--------------|--|--------------|
| ACV, BTR (R-145BM)/BRDM-2U .....   | 1            | HF/VHF, Vehicle Mount,<br>Medium-Power ..... | 2            |
| Truck, Utility .....   | 2            | HF, Vehicle Mount,<br>Medium-Power .....     | 1            |
| Radar, Battlefield Surveillance, Man-<br>Portable, PSNR-1 or TALL MIKE ..... | 1            | Radio Relay, VHF/UHF.....                    | 1            |
| Radios:  |              | Warning Receiver .....                       | 1            |
| VHF, Manpack, Low-Power .....  | 1            |  |              |
| VHF, Vehicle Mount,<br>Medium-Power .....                                    | 1            |  |              |

**Antitank Gun Battery, Antitank Bn (Standard)  
or Antitank Gun Bn**

---

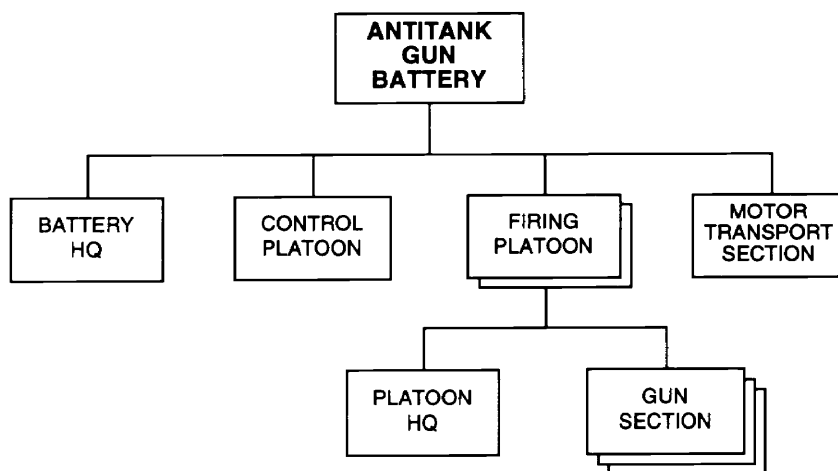

**PRINCIPAL ITEMS OF EQUIPMENT**

| <u>Equipment</u>   | <u>Total</u> | <u>Equipment</u>                          | <u>Total</u> |
|--|--------------|---|--------------|
| 100-mm Antitank Gun, T-12/MT-12.....   | 6            | Radios:                                   |              |
| Truck, Medium .....  | 8            | VHF, Manpack, Low-Power .....             | 1            |
| Trailer, Cargo, 2-Axle.....  | 1            | VHF, Vehicle Mount,<br>Medium-Power ..... | 7            |
| Rangefinder, Stereoscopic, DS-1 .....  | 1            |   |              |
| Radar, Battlefield Surveillance, Man-<br>Portable, PSNR-1 or TALL MIKE ..... | 1            |   |              |

ATGM Battery, Antitank Bn or ATGM Bn \_\_\_\_\_

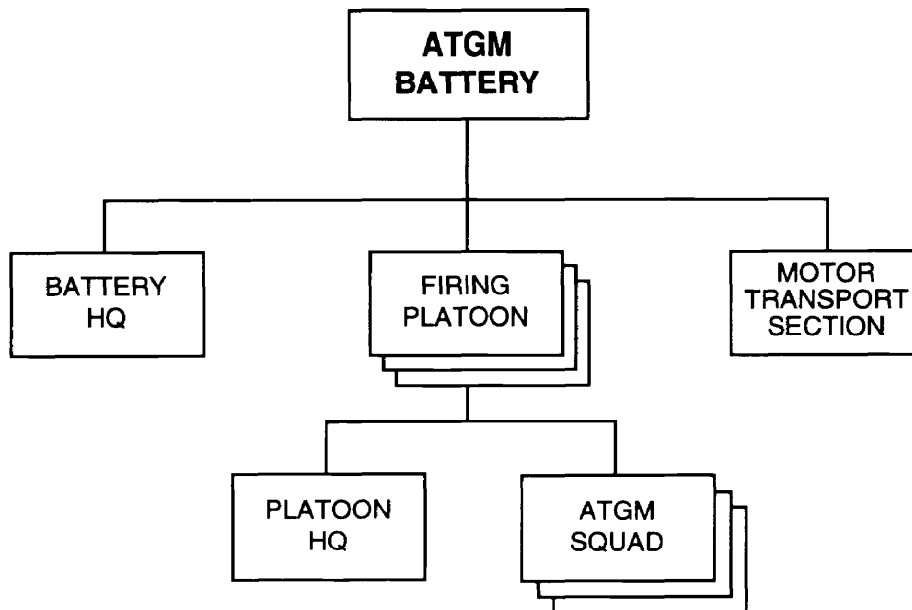

**PRINCIPAL ITEMS OF EQUIPMENT**

| <u>Equipment</u>  | <u>Total</u> | <u>Equipment</u>   | <u>Total</u> |
|---|--------------|--|--------------|
| ATGM Vehicle, 9P133 w/AT-3/SAGGER<br>or 9P148 w/AT-5/SPANDREL ..... | 9            | Radar, Battlefield Surveillance, Man-<br>Portable, PSNR-1 or TALL MIKE ..... | 1            |
| ATGL, RPG-7V .....  | 9            | Radios:  |              |
| ACV, BRDM-2U .....  | 4            | VHF, Manpack, Low-Power .....  | 4            |
| Truck, Medium .....   | 3            | VHF, Vehicle Mount,<br>Medium-Power .....                                    | 13           |
| Rangefinder, Stereoscopic, DS-1 .....                               | 1            |  |              |

**Materiel Support Platoon, Antitank Bn  
or Antitank Gun Bn or ATGM Bn**

---

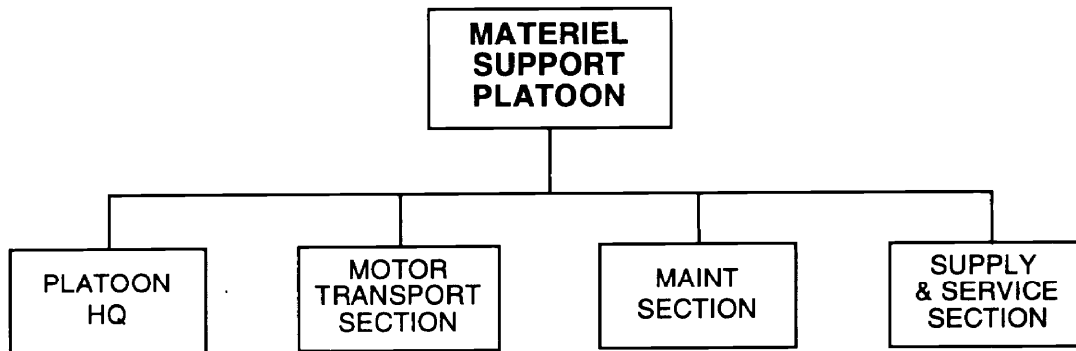

**PRINCIPAL ITEMS OF EQUIPMENT**

| <u>Equipment</u>              | <u>Total</u> | <u>Equipment</u>                 | <u>Total</u> |
|-------------------------------|--------------|----------------------------------|--------------|
| Truck, Utility .....          | 1            | Trailer, Generator.....          | 1            |
| Truck, Light .....            | 4            | Trailer, Kitchen.....            | 1            |
| Truck, Medium .....           | 7            | Trailer, POL (4,200-Liter) ..... | 3            |
| Truck, POL (5,000-Liter)..... | 3            | Trailer, Water (900-Liter) ..... | 1            |
| Van, Maintenance .....        | 2            | Radios:                          |              |
| Van, Signal.....              | 2            | VHF, Manpack, Low-Power.....     | 3            |
| Ambulance .....               | 1            | HF/VHF, Vehicle Mount,           |              |
| Trailer, Cargo, 2-Axle.....   | 8            | Medium-Power .....               | 1            |

**Reconnaissance and Electronic Combat Battalion, Mtzd Inf Div and Inf Div,  
or MD or Army or DMI**

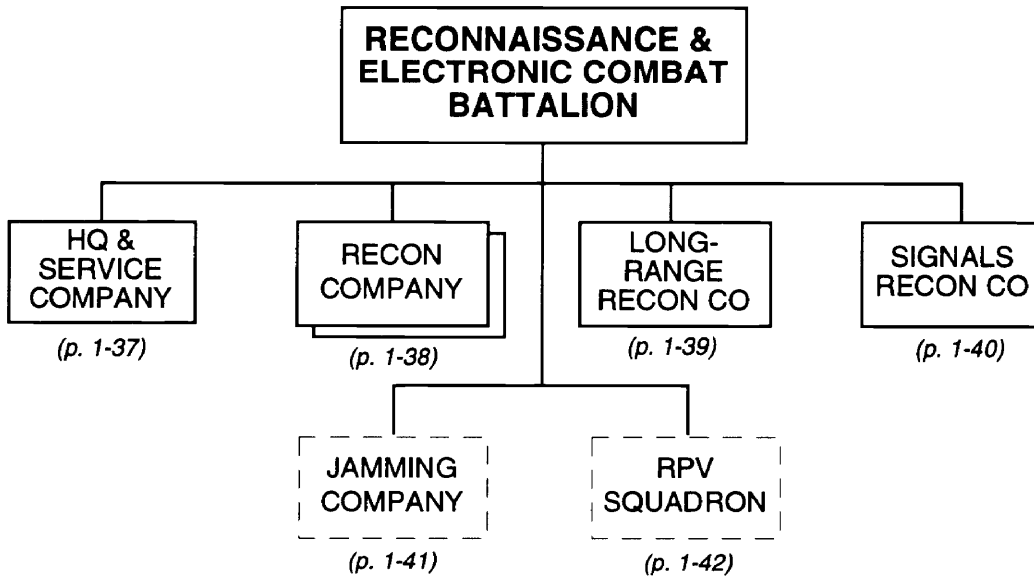

**NOTES:**

1. A reconnaissance and electronic combat (EC) battalion subordinate to the Directorate of Military Intelligence (DMI) would normally have an organic remotely-piloted vehicle (RPV) squadron. If the General Staff allocates a reconnaissance and EC battalion from the DMI to a military region or an expeditionary army, it normally includes an RPV squadron. District and divisional reconnaissance and EC battalions may or may not have an organic RPV squadron.
2. Some infantry divisions and more poorly equipped military districts may have a reconnaissance battalion that lacks a jamming company.
3. The equipment listing for the reconnaissance and EC battalion includes the assets of the jamming company as well as the RPV squadron.

**(continued)**



**Reconnaissance and Electronic Combat Battalion, Mtzd Inf Div and Inf DIV,  
or MD or Army or DMI (continued)**

| <i>Principal Items of Equipment</i> | <i>HQ &amp; Service Co</i> | <i>Recon Co (2x)</i> | <i>Long-Range Recon Co</i> | <i>Signals Recon Co</i> | <i>Jamming Co</i> | <i>RPV Sqdn</i> | <i>TOTAL</i> |
|-------------------------------------|----------------------------|----------------------|----------------------------|-------------------------|-------------------|-----------------|--------------|
| <b>ARMORED VEHICLES</b>             |                            |                      |                            |                         |                   |                 |              |
| ACV, BTR (R-145BM)                  | 2                          |                      |                            |                         |                   |                 | 2            |
| ACV, BRM-1K*                        | 1                          | 8                    |                            |                         |                   |                 | 9            |
| ACV, BRDM-2U                        |                            |                      | 1                          |                         |                   |                 | 1            |
| ASC, BRDM-2                         |                            | 12                   | 12                         |                         |                   |                 | 24           |
| <b>REMOTELY-PILOTED VEHICLES</b>    |                            |                      |                            |                         |                   |                 |              |
| RPV, Short-Range                    |                            |                      |                            |                         |                   | 4               | 4            |
| RPV Launch Vehicle (Truck, Medium)  |                            |                      |                            |                         |                   | 4               | 4            |
| RPV Recovery Vehicle (Truck, Crane) |                            |                      |                            |                         |                   | 2               | 2            |
| Van, Ground Control Station (RPV)   |                            |                      |                            |                         |                   | 2               | 2            |
| Van, Mission Control (RPV)          |                            |                      |                            |                         |                   | 1               | 1            |
| <b>ELECTRONIC COMBAT SYSTEMS</b>    |                            |                      |                            |                         |                   |                 |              |
| Radar Intercept/DF                  |                            |                      |                            | 3                       |                   |                 | 3            |
| Radio Intercept/DF, VHF/HF          |                            |                      |                            | 7                       | 3                 |                 | 10           |
| Communications Jammer, VHF          |                            |                      |                            |                         | 6                 |                 | 6            |
| Communications Jammer, HF           |                            |                      |                            |                         | 3                 |                 | 3            |
| Proximity Fuze Jammer               |                            |                      |                            |                         | 9                 |                 | 9            |
| <b>TRUCKS</b>                       |                            |                      |                            |                         |                   |                 |              |
| Truck, Utility                      | 4                          |                      |                            | 1                       |                   | 4               | 9            |
| Truck, Light                        | 5                          |                      |                            | 1                       | 2                 | 1               | 9            |
| Truck, Medium                       | 4                          |                      |                            |                         |                   | 1               | 5            |
| Truck, POL (5,000-L)                | 3                          |                      |                            |                         |                   |                 | 3            |
| Truck, Water (2,000-L)              | 1                          |                      |                            |                         |                   |                 | 1            |
| Van, Command                        | 2                          |                      |                            | 1                       | 1                 | 1               | 5            |
| Van, Jammer                         |                            |                      |                            |                         | 18                |                 | 18           |
| Van, Maintenance                    | 1                          |                      |                            | 1                       | 1                 | 1               | 4            |
| Van, Signal                         | 6                          |                      |                            |                         |                   |                 | 6            |
| Van, Signals Reconnaissance         |                            |                      |                            | 10                      | 3                 |                 | 13           |
| Ambulance                           | 1                          |                      |                            |                         |                   |                 | 1            |
| <b>TRAILERS</b>                     |                            |                      |                            |                         |                   |                 |              |
| Trailer, Generator                  | 1                          |                      |                            | 11                      | 21                | 3               | 36           |
| Trailer, Kitchen                    | 6                          |                      |                            | 1                       | 1                 | 1               | 9            |
| Trailer, POL (4,200-L)              | 3                          |                      |                            |                         |                   |                 | 3            |
| Trailer, Water (900-L)              | 2                          |                      |                            | 1                       | 1                 | 1               | 5            |
| <b>RADIOS</b>                       |                            |                      |                            |                         |                   |                 |              |
| VHF, Manpack, Low-Power             | 2                          | 20                   | 13                         | 7                       |                   | 13              | 55           |
| VHF, Vehicle Mount, Medium-Power    | 3                          | 20                   | 13                         |                         | 22                | 4               | 62           |
| HF, Manpack, Low-Power              | 2                          | 2                    | 1                          | 4                       |                   |                 | 9            |
| HF, Vehicle Mount, Medium-Power     | 1                          | 2                    | 1                          |                         | 1                 | 1               | 6            |
| HF/VHF, Vehicle Mount, Med-Power    | 2                          |                      |                            | 4                       |                   |                 | 6            |
| HF/VHF, Vehicle Mount, High-Power   | 1                          |                      |                            | 1                       |                   |                 | 2            |
| Radio Relay, VHF/UHF                | 1                          |                      |                            |                         |                   |                 | 1            |
| Radio Telegraph                     | 6                          |                      |                            |                         |                   |                 | 6            |
| Warning Receiver                    | 2                          | 2                    | 1                          | 1                       | 1                 | 1               | 8            |

**FOOTNOTE:**

\*This system includes the TALL MIKE battlefield surveillance radar.

**Headquarters and Service Company,  
Recon & EC Bn**

---

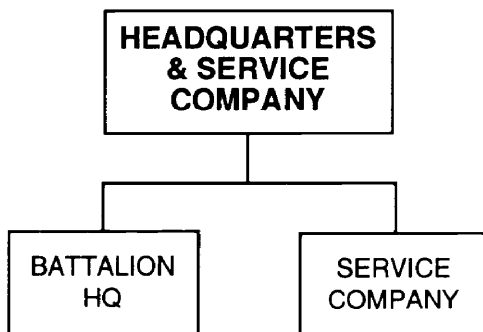

**PRINCIPAL ITEMS OF EQUIPMENT**

| <u>Equipment</u>                 | <u>Total</u> |
|----------------------------------|--------------|
| ACV, BRM-1K* .....               | 1            |
| ACV, BTR (R-145BM) .....         | 2            |
| 5.45-mm LMG, RPK-74 .....        | 4            |
| ATRL, RPG-18/22 .....            | 4            |
| Truck, Utility .....             | 4            |
| Truck, Light .....               | 5            |
| Truck, Medium .....              | 4            |
| Truck, POL (5,000-Liter) .....   | 3            |
| Truck, Water (2,000-Liter) ..... | 1            |
| Van, Command .....               | 2            |
| Van, Maintenance .....           | 1            |
| Van, Signal .....                | 6            |
| Ambulance .....                  | 1            |
| Trailer, Generator .....         | 1            |
| Trailer, Kitchen .....           | 6            |
| Trailer, POL (4,200-Liter) ..... | 3            |

| <u>Equipment</u>                             | <u>Total</u> |
|--|--------------|
| Trailer, Water (900-Liter) .....             | 2            |
| Radios:                                      |              |
| VHF, Manpack, Low-Power .....                | 2            |
| VHF, Vehicle Mount,<br>Medium-Power .....    | 3            |
| HF/VHF, Vehicle Mount,<br>Medium-Power ..... | 2            |
| HF/VHF, Vehicle Mount,<br>High-Power .....   | 1            |
| HF, Manpack, Low-Power .....                 | 2            |
| HF, Vehicle Mount,<br>Medium-Power .....     | 1            |
| Radio Relay, VHF/UHF .....                   | 1            |
| Radio Telegraph .....                        | 6            |
| Warning Receiver .....                       | 2            |

**FOOTNOTE:** \* This system includes the TALL MIKE battlefield surveillance radar.

Reconnaissance Company, Recon & EC Bn, Mtzd Inf Div  
and Inf Div, or MD or Army or DMI \_\_\_\_\_

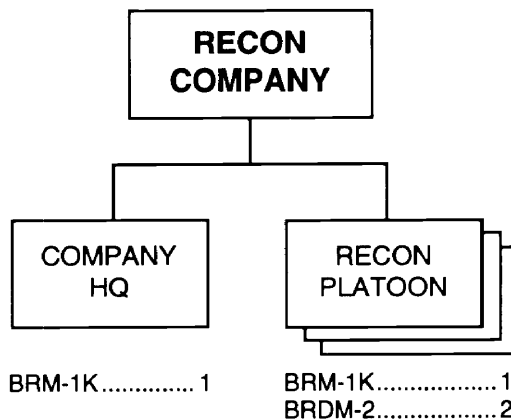

**PRINCIPAL ITEMS OF EQUIPMENT**

| <u>Equipment</u>                                   | <u>Total</u> |
|--|--------------|
| ACV, BRM-1K* .....                                 | 4            |
| ASC, BRDM-2 .....                                  | 6            |
| 9-mm Pistol, PM.....                               | 22           |
| 5.45-mm Assault Rifle, AK-74.....                  | 38           |
| 5.45-mm LMG, RPK-74 .....                          | 4            |
| 40-mm Under-Barrel Grenade Launcher,<br>BG-15..... | 14           |
| ATGL, RPG-7V .....                                 | 4            |
| ATRL, RPG-18/22.....                               | 6            |
| Night-Vision Goggles .....                         | 10           |

| <u>Equipment</u>                          | <u>Total</u> |
|---|--------------|
| Night-Vision Sight (Small Arms) .....     | 10           |
| Radios:                                   |              |
| VHF, Manpack, Low-Power .....             | 10           |
| VHF, Vehicle Mount,<br>Medium-Power ..... | 10           |
| HF, Vehicle Mount,<br>Medium-Power .....  | 1            |
| HF, Manpack, Low-Power.....               | 1            |
| Warning Receiver .....                    | 1            |

*NOTE:* Motorized infantry and infantry divisions, military districts, an expeditionary army, or the DMI could have either this reconnaissance company or a variant of the above with APCs, BTR-60/70/80 replacing the BRDM-2s.

*FOOTNOTE:* \* This system includes the TALL MIKE battlefield surveillance radar.

**Long-Range Reconnaissance Company,  
Recon & EC Bn**

---

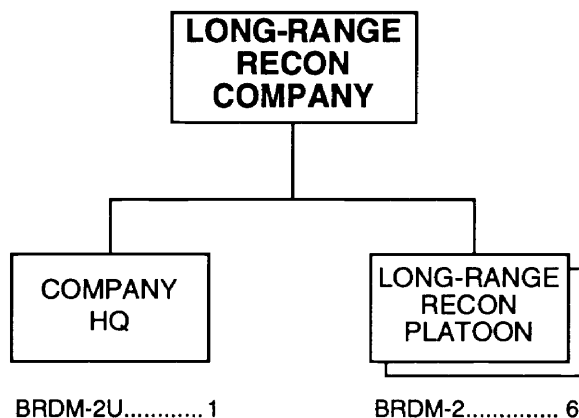

**PRINCIPAL ITEMS OF EQUIPMENT**

| <u>Equipment</u>                     | <u>Total</u> | <u>Equipment</u>                      | <u>Total</u> |
|--------------------------------------|--------------|---------------------------------------|--------------|
| ACV, BRDM-2U .....                   | 1            | Night-Vision Sight (Small Arms) ..... | 13           |
| ASC, BRDM-2 .....                    | 12           | Radios:                               |              |
| 9-mm Pistol, PM .....                | 16           | VHF, Manpack, Low-Power .....         | 13           |
| 5.45-mm Assault Rifle, AK-74 .....   | 23           | VHF, Vehicle Mount,                   |              |
| 5.45-mm LMG, RPK-74 .....            | 13           | Medium-Power .....                    | 13           |
| 40-mm Under-Barrel Grenade Launcher, |              | HF, Manpack, Low-Power .....          | 1            |
| BG-15 .....                          | 13           | HF, Vehicle Mount,                    |              |
| ATRL, RPG-18/22 .....                | 13           | Medium-Power .....                    | 1            |
| Night-Vision Goggles .....           | 13           | Warning Receiver .....                | 1            |

**NOTES:**

1. Personnel in the long-range reconnaissance company have parachute training. Small teams of four to six men can enter the enemy rear area by parachute, helicopter, vehicle, or on foot. They can also land by transport helicopter with their combat vehicles.
2. A variant of the long-range reconnaissance company could have 12 APCS, BTR-60/70/80 instead of the BRDM-2s. In that case, the command vehicle could be either a BRDM-2U or a command variant of the BTR.

Signals Reconnaissance Company,  
Recon & EC Bn

---

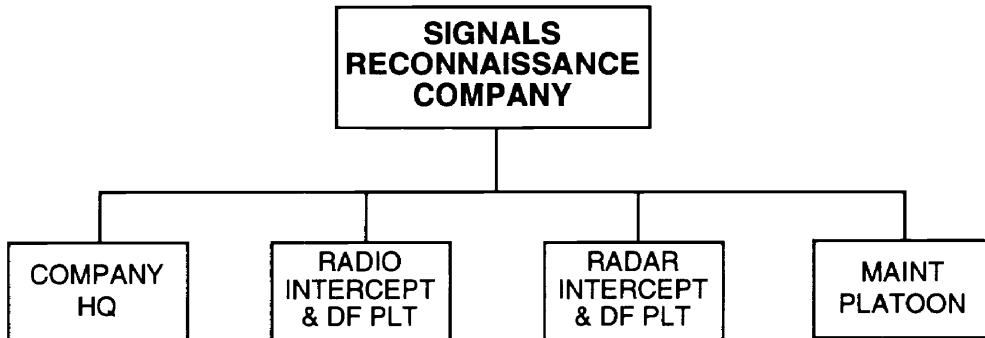

**PRINCIPAL ITEMS OF EQUIPMENT**

| <u>Equipment</u>                                  | <u>Total</u> |
|---|--------------|
| Radio Intercept/Direction Finder,<br>HF/VHF ..... | 7            |
| Radar Intercept/Direction Finder .....            | 3            |
| Truck, Utility .....                              | 1            |
| Truck, Light .....                                | 1            |
| Van, Command .....                                | 1            |
| Van, Maintenance .....                            | 1            |
| Van, Signals Reconnaissance .....                 | 10           |
| Trailer, Generator.....                           | 11           |
| Trailer, Kitchen.....                             | 1            |

| <u>Equipment</u>                             | <u>Total</u> |
|--|--------------|
| Trailer, Water (900-Liter) .....             | 1            |
| Radios:                                      |              |
| VHF, Manpack, Low-Power.....                 | 7            |
| HF/VHF, Vehicle Mount,<br>Medium-Power ..... | 4            |
| HF/VHF, Vehicle Mount,<br>High-Power .....   | 1            |
| HF, Manpack, Low-Power.....                  | 4            |
| Warning Receiver .....                       | 1            |

Jamming Company, Recon & EC Bn

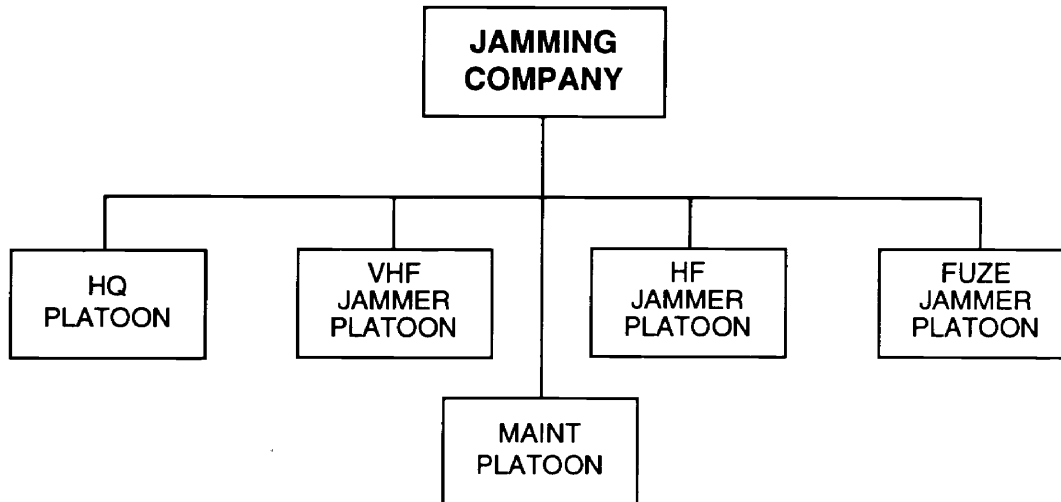

**PRINCIPAL ITEMS OF EQUIPMENT**

| <u>Equipment</u>                                  | <u>Total</u> | <u>Equipment</u>                 | <u>Total</u> |
|---|--------------|----------------------------------|--------------|
| Radio Intercept/Direction Finder,<br>VHF/HF ..... | 3            | Trailer, Generator .....         | 21           |
| Communications Jammer, VHF .....                  | 6            | Trailer, Kitchen .....           | 1            |
| Communications Jammer, HF .....                   | 3            | Trailer, Water (900-Liter) ..... | 1            |
| Proximity Fuze Jammer .....                       | 9            | Radios:                          |              |
| Truck, Light .....                                | 2            | VHF, Vehicle Mount,              |              |
| Van, Command .....                                | 1            | Medium-Power .....               | 22           |
| Van, Jammer .....                                 | 18           | HF, Vehicle-Mount,               |              |
| Van, Maintenance .....                            | 1            | Medium-Power .....               | 1            |
| Van, Signals Reconnaissance .....                 | 3            | Warning Receiver .....           | 1            |

RPV Squadron, Recon & EC Bn

---

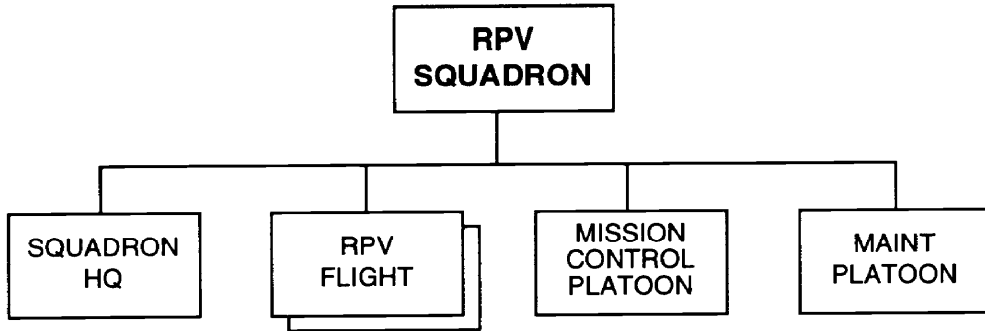

**PRINCIPAL ITEMS OF EQUIPMENT**

| <u>Equipment</u>                               | <u>Total</u> | <u>Equipment</u>                          | <u>Total</u> |
|--|--------------|---|--------------|
| RPV Launch Vehicle (Truck, Medium).....        | 4            | Van, Maintenance .....                    | 1            |
| RPV Recovery Vehicle<br>(Truck, Crane).....    | 2            | Trailer, Generator.....                   | 3            |
| Remotely-Piloted Vehicle<br>(Short-Range)..... | 4            | Trailer, Kitchen.....                     | 1            |
| Van, Mission Control (RPV) .....               | 1            | Trailer, Water (900-Liter) .....          | 1            |
| Van, Ground Control Station (RPV) .....        | 2            | Radios:                                   |              |
| Truck, Utility .....                           | 4            | VHF, Manpack, Low-Power .....             | 13           |
| Truck, Light .....                             | 1            | VHF, Vehicle Mount,<br>Medium-Power ..... | 4            |
| Truck, Medium .....                            | 1            | HF, Vehicle Mount,<br>Medium-Power .....  | 1            |
| Van, Command .....                             | 1            | Warning Receiver .....                    | 1            |

**NOTE:** An expeditionary army, the CDF, and higher levels of command normally have a reconnaissance and EC battalion with an organic remotely-piloted vehicle (RPV) squadron. If the General Staff allocates a reconnaissance and EC battalion from the DMI to a region, it normally includes an RPV squadron. District and divisional reconnaissance and EC battalions may or may not have an organic RPV squadron. The equipment listing for the reconnaissance and EC battalion includes the RPV squadron.

**Chemical Defense Company, Mtzd Inf Div  
and Inf Div, or MD**

---

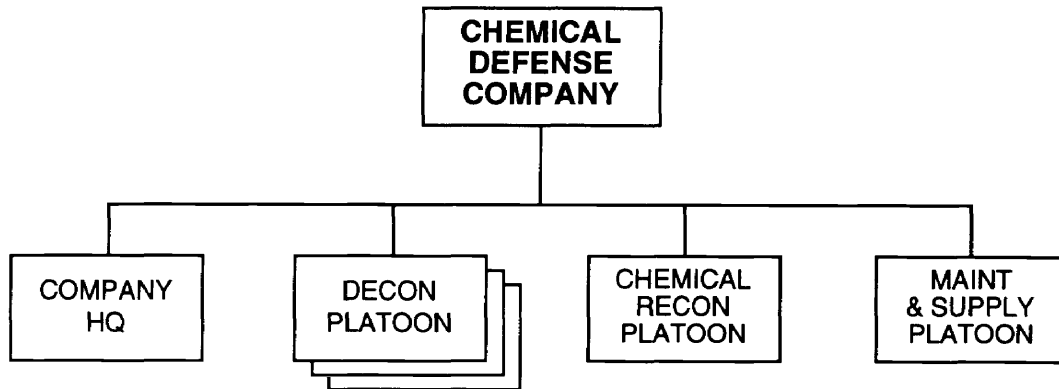

**PRINCIPAL ITEMS OF EQUIPMENT**

| <u>Equipment</u>                           | <u>Total</u> | <u>Equipment</u>                   | <u>Total</u> |
|--|--------------|------------------------------------|--------------|
| Chemical Recon Vehicle,<br>BRDM-2RKh*..... | 4            | Truck, Water (2,000-Liter) .....   | 2            |
| Truck, Decon, ARS-12U/14 .....             | 4            | Trailer, POL (4,200-Liter) .....   | 1            |
| Truck, Decon, DDA-53/66** .....            | 8            | Trailer, Water (1,200-Liter) ..... | 2            |
| Truck, Decon, TMS-65 .....                 | 2            | Trailer, Water (900-Liter) .....   | 2            |
| Truck, Utility .....                       | 2            | Radios:                            |              |
| Truck, Light .....                         | 3            | VHF, Vehicle Mount,                |              |
| Truck, Medium .....                        | 6            | Medium-Power .....                 | 4            |
| Truck, POL (5,000-Liter).....              | 1            | HF, Manpack, Low-Power.....        | 2            |

**FOOTNOTES:**

\* Some motorized infantry or infantry divisions may use the truck-mounted chemical reconnaissance vehicle UAZ-69RKh instead of the armored BRDM-2RKh.

\*\* Some infantry divisions may use the single-axle DDP decontamination trailer, towed by a light truck, to perform the same personnel decontamination function as the truck-mounted DDA-53/66.



**Materiel Support Battalion, Mtzd Inf Div and  
Inf Div, or MD or Army or National**

---

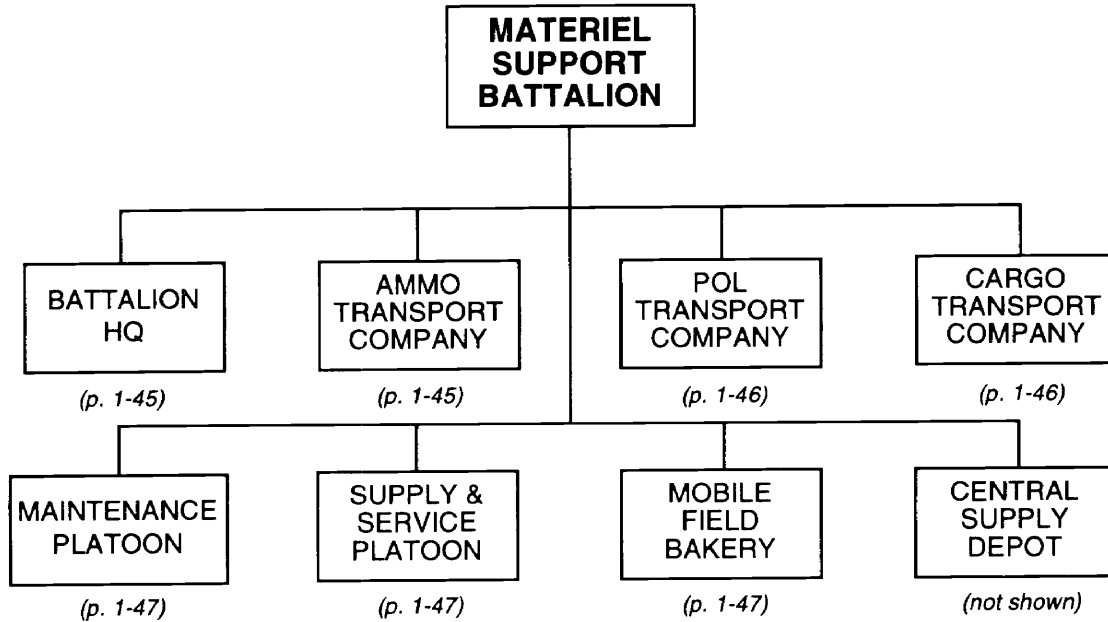

**PRINCIPAL ITEMS OF EQUIPMENT**

| <u>Equipment</u>               | <u>Total</u> |
|--------------------------------|--------------|
| SAM, Shoulder-Fired.....       | 2            |
| ATRL, RPG-18/22.....           | 11           |
| Truck, Utility .....           | 5            |
| Truck, Light .....             | 33           |
| Truck, Medium .....            | 98           |
| Truck, Crane .....             | 3            |
| Truck, Kitchen .....           | 2            |
| Truck, POL (5,000-Liter).....  | 50           |
| Truck, Water (900-Liter) ..... | 6            |
| Van, Maintenance .....         | 11           |
| Van, Mobile Field Bakery.....  | 4            |
| Van, Signal.....               | 1            |

| <u>Equipment</u>                             | <u>Total</u> |
|--|--------------|
| Ambulance .....                              | 1            |
| Trailer, Cargo, 1-Axle.....                  | 2            |
| Trailer, Cargo, 2-Axle.....                  | 64           |
| Trailer, Generator.....                      | 6            |
| Trailer, POL (4,200-Liter) .....             | 50           |
| Trailer, Water (900-Liter) .....             | 7            |
| Radios:                                      |              |
| VHF, Manpack, Low-Power .....                | 3            |
| HF/VHF, Vehicle Mount,<br>Medium-Power ..... | 1            |
| HF, Manpack, Low-Power.....                  | 1            |
| Warning Receiver .....                       | 1            |

**Battalion Headquarters, Mat Spt Bn or  
Motor Transport Bn**

---



**PRINCIPAL ITEMS OF EQUIPMENT**

| <u>Equipment</u>            | <u>Total</u> | <u>Equipment</u>            | <u>Total</u> |
|-----------------------------|--------------|-----------------------------|--------------|
| SAM, Shoulder-Fired.....    | 2            | Radios:                     |              |
| Truck, Utility .....        | 2            | HF/VHF, Vehicle Mount,      |              |
| Van, Maintenance .....      | 1            | Medium-Power .....          | 1            |
| Van, Signal.....            | 1            | HF, Manpack, Low-Power..... | 1            |
| Trailer, Cargo, 2-Axle..... | 2            | Warning Receiver .....      | 1            |

**Ammunition Transport Company,  
Mat Spt Bn**

---

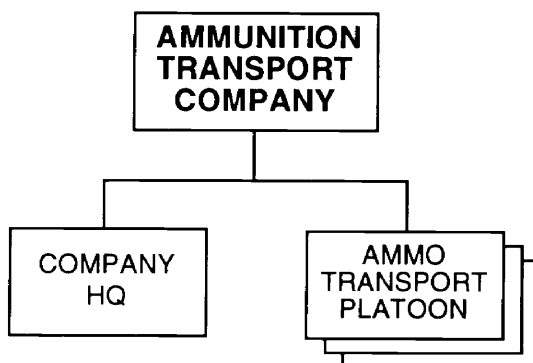

**PRINCIPAL ITEMS OF EQUIPMENT**

| <u>Equipment</u>     | <u>Total</u> | <u>Equipment</u>                     | <u>Total</u> |
|----------------------|--------------|--------------------------------------|--------------|
| ATRL, RPG-18/22..... | 3            | Truck, Crane .....                   | 1            |
| Truck, Utility ..... | 1            | Trailer, Cargo, 2-Axle.....          | 60           |
| Truck, Medium .....  | 60           | Radio, VHF, Manpack, Low-Power ..... | 1            |

**POL Transport Company, Mat Spt Bn**

---

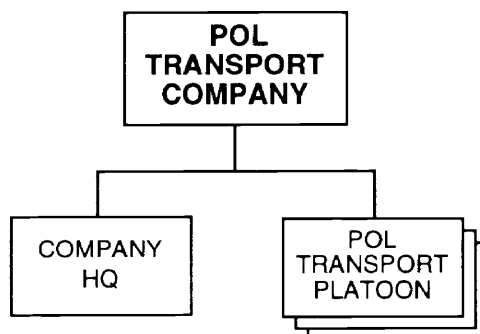

**PRINCIPAL ITEMS OF EQUIPMENT**

| <u>Equipment</u>              | <u>Total</u> | <u>Equipment</u>                     | <u>Total</u> |
|-------------------------------|--------------|--------------------------------------|--------------|
| ATRL, RPG-18/22 .....         | 3            | Trailer, POL (4,200-Liter) .....     | 50           |
| Truck, Utility .....          | 1            | Radio, VHF, Manpack, Low-Power ..... | 1            |
| Truck, POL (5,000-Liter)..... | 50           |                                      |              |

**Cargo Transport Company, Mat Spt Bn**

---

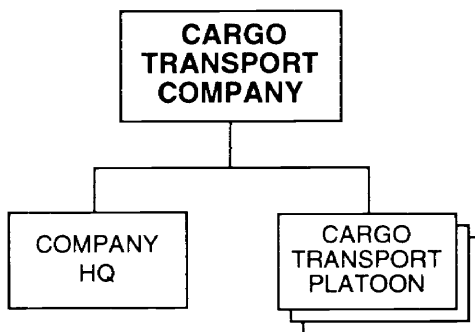

**PRINCIPAL ITEMS OF EQUIPMENT**

| <u>Equipment</u>      | <u>Total</u> | <u>Equipment</u>                     | <u>Total</u> |
|-----------------------|--------------|--------------------------------------|--------------|
| ATRL, RPG-18/22 ..... | 3            | Truck, Medium .....                  | 30**         |
| Truck, Utility .....  | 1            | Truck, Crane .....                   | 1            |
| Truck, Light .....    | 30*          | Radio, VHF, Manpack, Low-Power ..... | 1            |

**FOOTNOTES:**

\* In a mechanized infantry division, each of these light trucks can pull a 1-axle cargo trailer.

\*\* In a mechanized infantry division, each of these medium trucks can pull a 2-axle cargo trailer.

Maintenance Platoon, Mat Spt Bn \_\_\_\_\_

MAINTENANCE  
PLATOON

**PRINCIPAL ITEMS OF EQUIPMENT**

| <u>Equipment</u>       | <u>Total</u> | <u>Equipment</u>        | <u>Total</u> |
|------------------------|--------------|-------------------------|--------------|
| ATRL, RPG-18/22.....   | 1            | Trailer, Generator..... | 6            |
| Van, Maintenance ..... | 9            | Truck, Crane .....      | 1            |

Supply and Service Platoon, Mat Spt Bn \_\_\_\_\_

SUPPLY &  
SERVICE  
PLATOON

**PRINCIPAL ITEMS OF EQUIPMENT**

| <u>Equipment</u>                 | <u>Total</u> | <u>Equipment</u>                 | <u>Total</u> |
|----------------------------------|--------------|----------------------------------|--------------|
| ATRL, RPG-18/22.....             | 1            | Ambulance .....                  | 1            |
| Truck, Light .....               | 3            | Trailer, Cargo, 1-Axle.....      | 2            |
| Truck, Kitchen .....             | 2            | Trailer, Cargo, 2-Axle.....      | 2            |
| Truck, Water (2,000-Liter) ..... | 6            | Trailer, Water (900-Liter) ..... | 3            |
| Van, Maintenance .....           | 1            |                                  |              |

Mobile Field Bakery, Mat Spn Bn \_\_\_\_\_

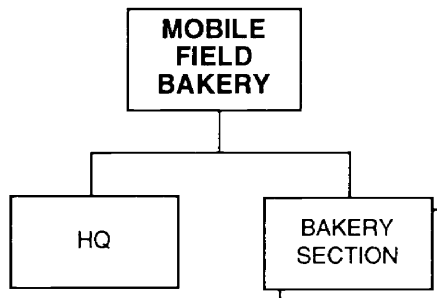

**PRINCIPAL ITEMS OF EQUIPMENT**

| <u>Equipment</u>              | <u>Total</u> | <u>Equipment</u>                 | <u>Total</u> |
|-------------------------------|--------------|----------------------------------|--------------|
| Truck, Medium .....           | 8            | Trailer, Water (900-Liter) ..... | 4            |
| Van, Mobile Field Bakery..... | 4            |                                  |              |

Maintenance Battalion, Mtzd Inf Div or MD  
or MR or Army or CDF or National

---

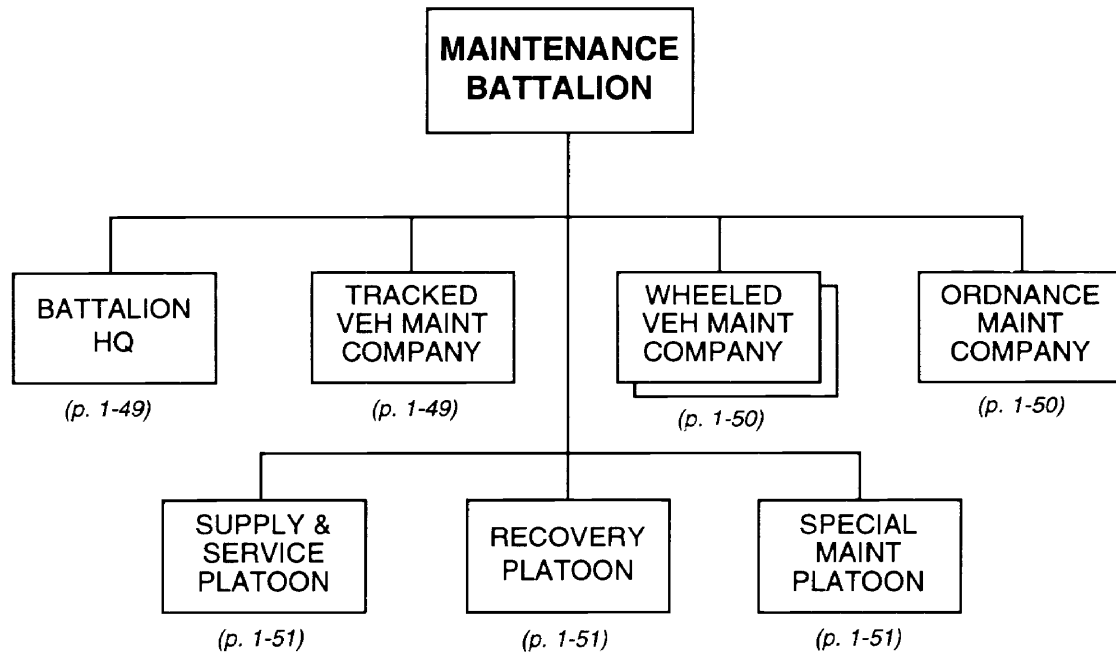

**PRINCIPAL ITEMS OF EQUIPMENT**

| <u>Equipment</u>                  | <u>Total</u> |
|-----------------------------------|--------------|
| ATRL, RPG-18/22.....              | 15           |
| Truck, Utility .....              | 6            |
| Truck, Light .....                | 4            |
| Truck, Medium .....               | 26           |
| Truck, Crane .....                | 4            |
| Truck, POL (5,000-Liter).....     | 5            |
| Truck, Recovery.....              | 2            |
| Truck, Water (2,000-Liter) .....  | 1            |
| Van, Light .....                  | 4            |
| Van, Maintenance .....            | 54           |
| Van, Signal.....                  | 1            |
| Ambulance .....                   | 1            |
| Tracked Amphibian, K-61/PTS ..... | 1            |
| Tractor, Artillery, AT-S.....     | 1            |
| Motorcycle .....                  | 3            |
| Armored Recovery Vehicle .....    | 2            |

| <u>Equipment</u>                             | <u>Total</u> |
|--|--------------|
| Trailer, Cargo, 2-Axle.....                  | 17           |
| Trailer, Generator.....                      | 9            |
| Trailer, Kitchen.....                        | 3            |
| Trailer, POL (4,200-Liter) .....             | 4            |
| Trailer, Water (900-Liter) .....             | 1            |
| Tractor-Trailer, Lowboy .....                | 2            |
| Radios:                                      |              |
| VHF, Manpack, Low-Power .....                | 6            |
| VHF, Vehicle Mount,<br>Medium-Power .....    | 4            |
| HF/VHF, Vehicle Mount,<br>Medium-Power ..... | 1            |
| HF, Vehicle Mount,<br>Medium-Power .....     | 1            |
| Warning Receiver .....                       | 1            |

Battalion Headquarters, Maint Bn \_\_\_\_\_



**PRINCIPAL ITEMS OF EQUIPMENT**

| <u>Equipment</u>     | <u>Total</u> | <u>Equipment</u>                             | <u>Total</u> |
|----------------------|--------------|--|--------------|
| Truck, Utility ..... | 2            | Radios:                                      |              |
| Van, Signal.....     | 1            | VHF, Manpack, Low-Power.....                 | 1            |
| Motorcycle .....     | 3            | HF/VHF, Vehicle Mount,<br>Medium-Power ..... | 1            |
|                      |              | Warning Receiver .....                       | 1            |

Tracked Vehicle Maintenance Company,  
Maint Bn \_\_\_\_\_

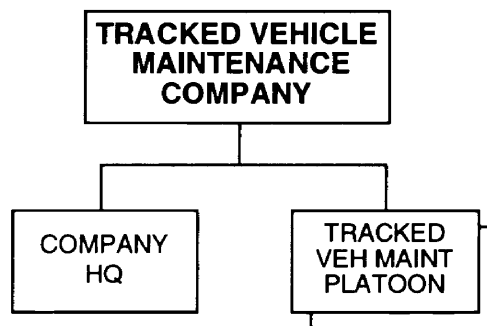

**PRINCIPAL ITEMS OF EQUIPMENT**

| <u>Equipment</u>     | <u>Total</u> | <u>Equipment</u>                     | <u>Total</u> |
|----------------------|--------------|--------------------------------------|--------------|
| ATRL, RPG-18/22..... | 3            | Van, Maintenance .....               | 12           |
| Truck, Utility ..... | 1            | Trailer, Cargo, 2-Axle.....          | 3            |
| Truck, Medium .....  | 4            | Trailer, Generator.....              | 2            |
| Truck, Crane .....   | 1            | Radio, VHF, Manpack, Low-Power ..... | 1            |
| Van, Light .....     | 1            |                                      |              |

**Wheeled Vehicle Maintenance Company,  
Maint Bn**

---

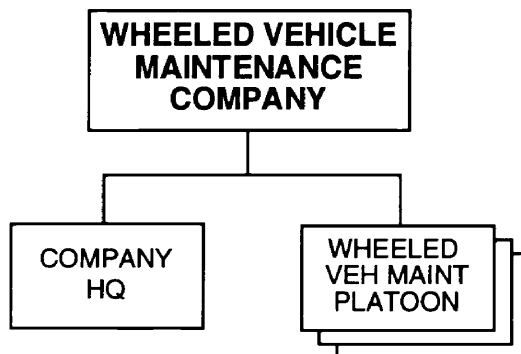

**PRINCIPAL ITEMS OF EQUIPMENT**

| <u>Equipment</u>     | <u>Total</u> | <u>Equipment</u>                     | <u>Total</u> |
|----------------------|--------------|--------------------------------------|--------------|
| ATRL, RPG-18/22..... | 4            | Van, Maintenance .....               | 14           |
| Truck, Utility ..... | 1            | Trailer, Cargo, 2-Axle.....          | 4            |
| Truck, Medium .....  | 6            | Trailer, Generator.....              | 2            |
| Truck, Crane .....   | 1            | Radio, VHF, Manpack, Low-Power ..... | 1            |
| Van, Light .....     | 1            |                                      |              |

**Ordnance Maintenance Company, Maint Bn**

---

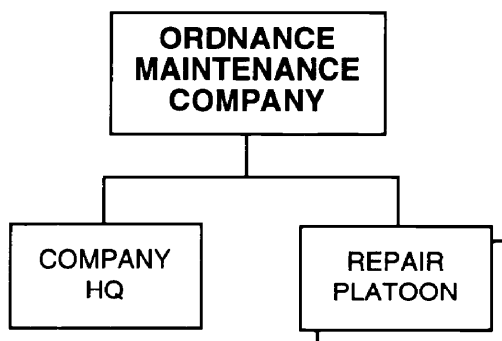

**PRINCIPAL ITEMS OF EQUIPMENT**

| <u>Equipment</u>     | <u>Total</u> | <u>Equipment</u>                     | <u>Total</u> |
|----------------------|--------------|--------------------------------------|--------------|
| ATRL, RPG-18/22..... | 3            | Van, Maintenance .....               | 8            |
| Truck, Utility ..... | 1            | Trailer, Cargo, 2-Axle.....          | 2            |
| Truck, Crane .....   | 1            | Trailer, Generator.....              | 2            |
| Van, Light .....     | 1            | Radio, VHF, Manpack, Low-Power ..... | 1            |

Supply and Service Platoon, Maint Bn,  
Mtzd Inf Div or MD

---

|   |
|---|
| <b>SUPPLY &amp;<br/>SERVICE<br/>PLATOON</b> |
|---|

**PRINCIPAL ITEMS OF EQUIPMENT**

| <u>Equipment</u>                | <u>Total</u> | <u>Equipment</u>                    | <u>Total</u> |
|---------------------------------|--------------|-------------------------------------|--------------|
| ATRL, RPG-18/22.....            | 1            | Trailer, Cargo, 2-Axle.....         | 4            |
| Truck, Light.....               | 4            | Trailer, Kitchen.....               | 3            |
| Truck, Medium.....              | 10           | Trailer, POL (4,200-Liter).....     | 5            |
| Truck, POL (5,000-Liter).....   | 5            | Trailer, Water (900-Liter).....     | 1            |
| Truck, Water (2,000-Liter)..... | 1            | Radio, VHF, Manpack, Low-Power..... | 1            |
| Ambulance.....                  | 1            |                                     |              |

Recovery Platoon, Maint Bn, Mtzd Inf Div and  
Inf Div, or MD

---

|                             |
|-----------------------------|
| <b>RECOVERY<br/>PLATOON</b> |
|-----------------------------|

**PRINCIPAL ITEMS OF EQUIPMENT**

| <u>Equipment</u>                 | <u>Total</u> | <u>Equipment</u>    | <u>Total</u> |
|----------------------------------|--------------|---------------------|--------------|
| Truck, Recovery.....             | 2            | Radios:             |              |
| Tracked Amphibian, K-61/PTS..... | 1            | VHF, Vehicle Mount, |              |
| Tractor, Artillery, AT-S.....    | 1            | Medium-Power.....   | 4            |
| Tractor-Trailer, Lowboy.....     | 2            | HF, Vehicle Mount,  |              |
| Armored Recovery Vehicle.....    | 2            | Medium-Power.....   | 1            |

Special Maintenance Platoon, Maint Bn

---

|  |
|--|
| <b>SPECIAL<br/>MAINTENANCE<br/>PLATOON</b> |
|--|

**PRINCIPAL ITEMS OF EQUIPMENT**

| <u>Equipment</u>      | <u>Total</u> | <u>Equipment</u>        | <u>Total</u> |
|-----------------------|--------------|-------------------------|--------------|
| Van, Maintenance..... | 6            | Trailer, Generator..... | 1            |



Medical Company, Mtzd Inf Div, Inf Div,  
and Mech Inf Div, or MI)

---

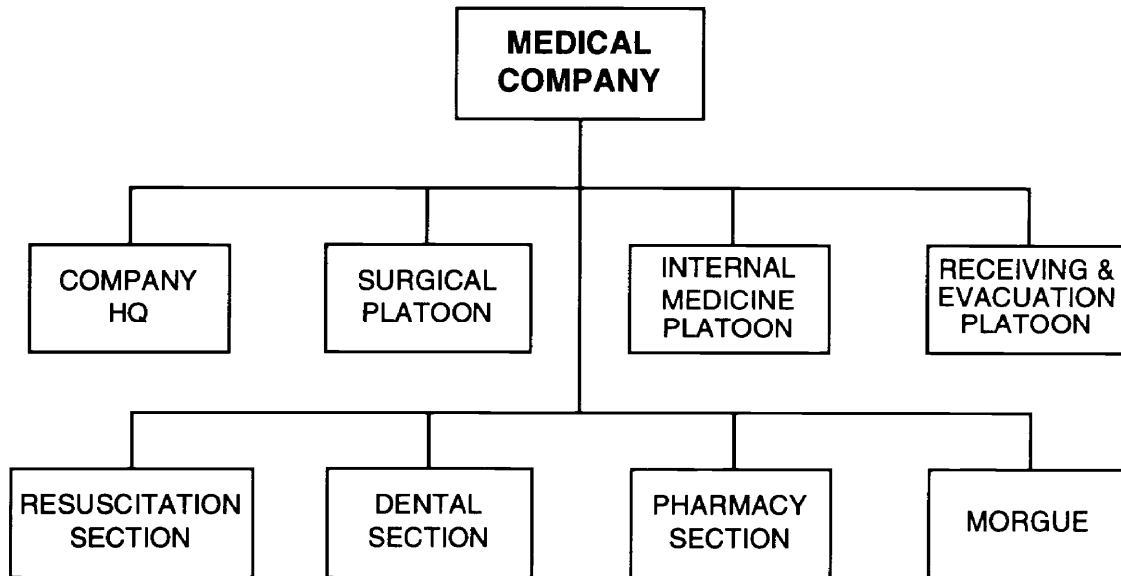

**PRINCIPAL ITEMS OF EQUIPMENT**

| <u>Equipment</u>                 | <u>Total</u> | <u>Equipment</u>                     | <u>Total</u> |
|----------------------------------|--------------|--------------------------------------|--------------|
| Truck, Utility .....             | 2            | Trailer, Cargo, 2-Axle.....          | 7            |
| Truck, Light .....               | 1            | Trailer, Generator.....              | 2            |
| Truck, Medium* .....             | 7            | Trailer, Kitchen.....                | 2            |
| Truck, Water (2,000-Liter) ..... | 2            | Trailer, Water (1,200-Liter) .....   | 1            |
| Van, Hospital .....              | 9            | Radio, VHF, Manpack, Low-Power ..... | 1            |
| Ambulance .....                  | 4            |                                      |              |

**FOOTNOTE:** \* In better-equipped units, additional hospital vans may replace these general-purpose cargo trucks. Cargo trucks may also serve as ambulances.

## Chapter 2

# Infantry and Mechanized Infantry Divisions

The majority of divisions in an infantry-based OPFOR are either infantry or motorized infantry. The primary difference between motorized infantry and infantry divisions is that the former has trucks at brigade level to transport its infantry maneuver elements, while the latter does not. Even an infantry-based force can have some mechanized infantry divisions with infantrymen mounted in APCs or IFVs. For information on the motorized infantry division, and the organizations it has in common with either infantry or mechanized infantry divisions, see Chapter 1. For more information on separate and divisional brigades, see Chapters 3 and 4.

Divisions can be either standing or mobilized from the reserves. Standing divisions may exist in districts along an international border, in districts that contain historically threatened avenues of approach, or around critical cities or facilities. Divisions mobilized from the reserves may draw combat support and combat service support from reserves or receive them from the national asset pool. The commander of the district in which a division is garrisoned or mobilized is also the division commander, as long as the division remains in that district.

## CONTENTS

|  |      |
|--|------|
| <b>Infantry Division</b> .....   | 2-3  |
| Antiaircraft Gun Battalion (Mixed), Inf Div.....   | 2-4  |
| Antiaircraft Heavy Machinegun Battery (14.5-mm), AA Gun Bn (Mixed)<br>or Abn Inf Bde or SAM Bn (SA-2 and SA-3) ..... | 2-5  |
| Antiaircraft Gun Battery (37-mm), AA Gun Bn (Mixed).....   | 2-6  |
| Maintenance Battalion, Inf Div or MD.....  | 2-7  |
| Supply and Service Platoon, Maint Bn, Inf Div or MD.....   | 2-8  |
| <b>Mechanized Infantry Division</b> .....  | 2-9  |
| Self-Propelled Artillery Regiment, Mech Inf Div or MD or Army or CDF<br>or National .....                            | 2-10 |
| Headquarters and Control Battery, SP Arty Regt or Arty Bde .....   | 2-13 |
| 122-mm Self-Propelled Howitzer Battalion, Mech Inf Bde (Sep and Div)<br>and Tank Bde, or SP Arty Regt .....          | 2-14 |
| 122-mm Self-Propelled Howitzer Battery, 122-mm SP Howitzer Bn.....   | 2-15 |
| 152-mm Self-Propelled Howitzer Battalion, SP Arty Regt.....  | 2-16 |
| 152-mm Self-Propelled Howitzer Battery, 152-mm SP Howitzer Bn.....   | 2-17 |
| Target Acquisition Battery, SP Arty Regt or Arty Bde.....  | 2-18 |

|  |      |
|--|------|
| Air Defense Regiment, Mech Inf Div or MD or Army or CDF or ADC.....  | 2-19 |
| SAM Battalion (SA-8), Air Defense Regt .....   | 2-21 |
| Missile Technical Platoon, SAM Bn (SA-8) .....   | 2-22 |
| SAM Squad, SAM Bn (SA-2, SA-3, and SA-8) or AA Gun Bn (57-mm)<br>or Missile Firing Btry (SA-6 and SA-8) or AA Gun Btry (57-mm)<br>or AA Gun Bn Mixed) or Missile Technical Plt, SAM Bn (SA-8)<br>or Missile Technical Btry, SAM Regt (SA-6 and SA-8) ..... | 2-23 |
| Supply and Service Company, SAM Bn (SA-8).....   | 2-23 |
| Antiaircraft Gun Battalion (57-mm), Air Defense Regt .....   | 2-24 |
| Service Battery, AA Gun Bn (57-mm) .....   | 2-25 |
| Materiel Support Company, Air Defense Regt.....  | 2-25 |
| ATGM Battalion, Mech Inf Bde (Sep) or Mech Inf Div or MD or Army or CDF<br>or National .....   | 2-26 |
| Reconnaissance and Electronic Combat Battalion, Mech Inf Div or MD<br>or Army or CDF or DMI.....   | 2-27 |
| Reconnaissance Company, Recon & EC Bn, Mech Inf Div or MD or Army<br>or CDF or DMI .....   | 2-29 |
| Engineer Battalion, Mech Inf Div, Mtzd Inf Div, and Inf Div, or MD or Army<br>or CDF or National (Engr Bde) .....  | 2-30 |
| Combat Engineer Company, Engr Bn or MR .....   | 2-32 |
| Assault Crossing Company, Engr Bn .....  | 2-33 |
| Construction Company, Engr Bn.....   | 2-34 |
| Road and Bridge Construction Company, Engr Bn.....   | 2-35 |
| Pontoon Bridge Company, Engr Bn or Pontoon Bridge Bn .....   | 2-36 |
| Signal Battalion, Mech Inf Div, Mtzd Inf Div, and Inf Div, or MD or Army or CDF<br>or National (Signal Bde) .....  | 2-37 |
| Battalion Headquarters, Signal Bn.....   | 2-38 |
| Radio Company, Signal Bn.....  | 2-38 |
| Radio Telephone and Telegraph Company, Signal Bn.....  | 2-39 |
| Supply and Service Platoon, Signal Bn .....  | 2-39 |
| Chemical Defense Company, Mech Inf Div or MD or Army or CDF.....   | 2-40 |
| Materiel Support Battalion, Mech Inf Div or MD or Army or CDF<br>or National .....   | 2-41 |
| Maintenance Battalion, Mech Inf Div or MD or MR or Army or CDF or National .....   | 2-42 |
| Supply and Service Platoon, Maint Bn, Mech Inf Div or MD or MR<br>or Army or CDF or National.....  | 2-43 |
| Recovery Platoon, Maint Bn, Mech Inf Div or MD or MR or Army<br>or CDF or National .....   | 2-43 |
| Medical Battalion, Mech Inf Div, Mtzd Inf Div, and Inf Div, or MD or Army<br>or CDF .....  | 2-44 |
| Battalion Headquarters, Med Bn.....  | 2-45 |
| Medical Company, Med Bn.....   | 2-45 |
| Collection and Evacuation Company, Med Bn.....   | 2-46 |
| Disinfection and Decontamination Platoon, Med Bn .....   | 2-46 |
| Supply and Service Platoon, Med Bn .....   | 2-47 |

## Infantry Division

---

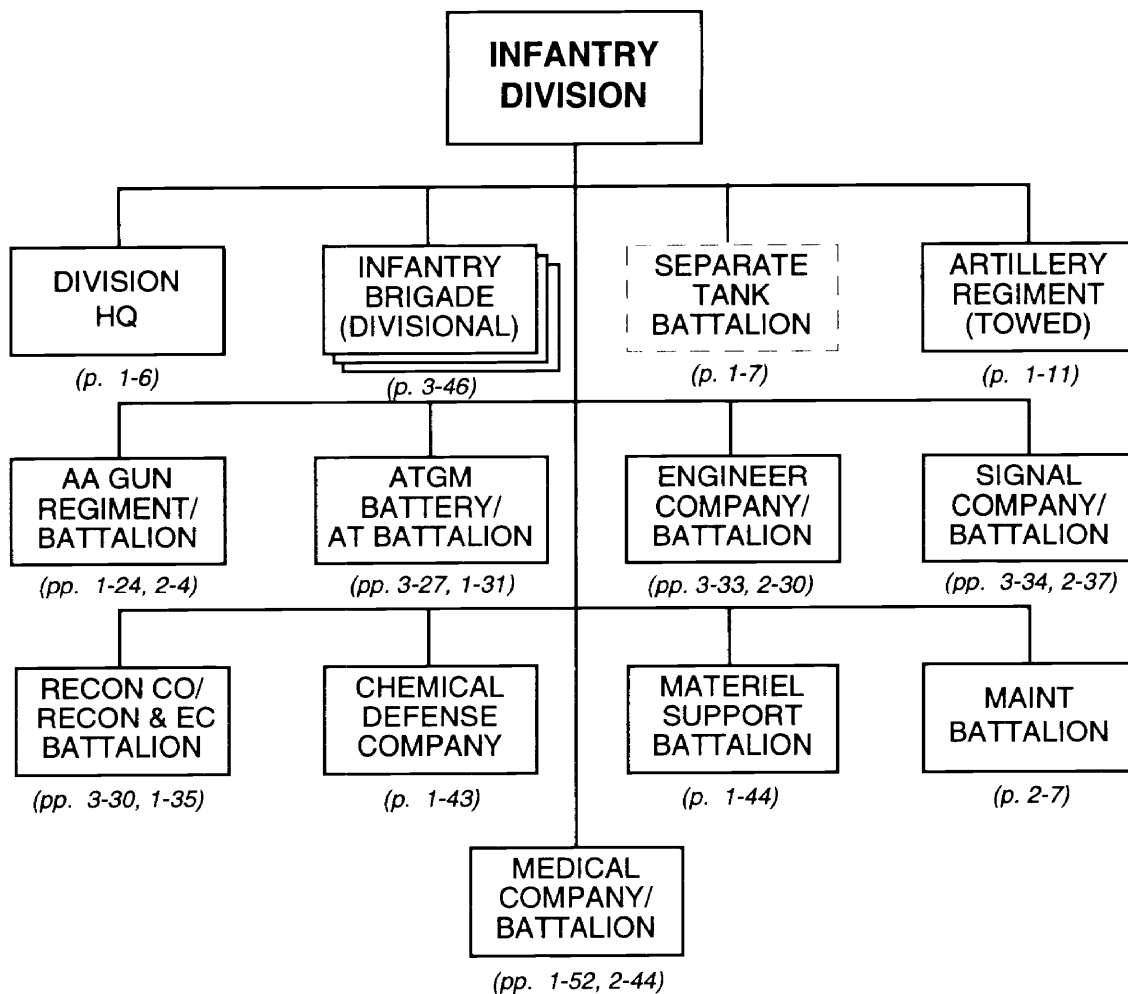

### NOTES:

1. The basic maneuver units in this division are infantry brigades (divisional). Divisional brigades differ structurally from their separate counterparts normally found within districts. In rare cases, an infantry division may include a separate tank battalion.
2. Most infantry divisions have company-sized engineer, signal, reconnaissance, and medical units. However, some better-equipped infantry divisions may have battalion-sized units of these types.
3. Divisions can either be standing or mobilized from the reserves. Standing divisions may exist in districts along an international border, in districts that contain historically threatened avenues of approach, or around critical cities/facilities. Standing divisions have the assets shown above, even before mobilization. Divisions mobilized from the reserves may draw the combat support and combat service support assets shown above from reserves or receive them from the national asset pool. The commander of the district in which a division is garrisoned or mobilized is also the division commander, as long as the division remains in that district.
4. Infantry divisions are less common than motorized infantry divisions.

Antiaircraft Gun Battalion (Mixed), Inf Div \_\_\_\_\_

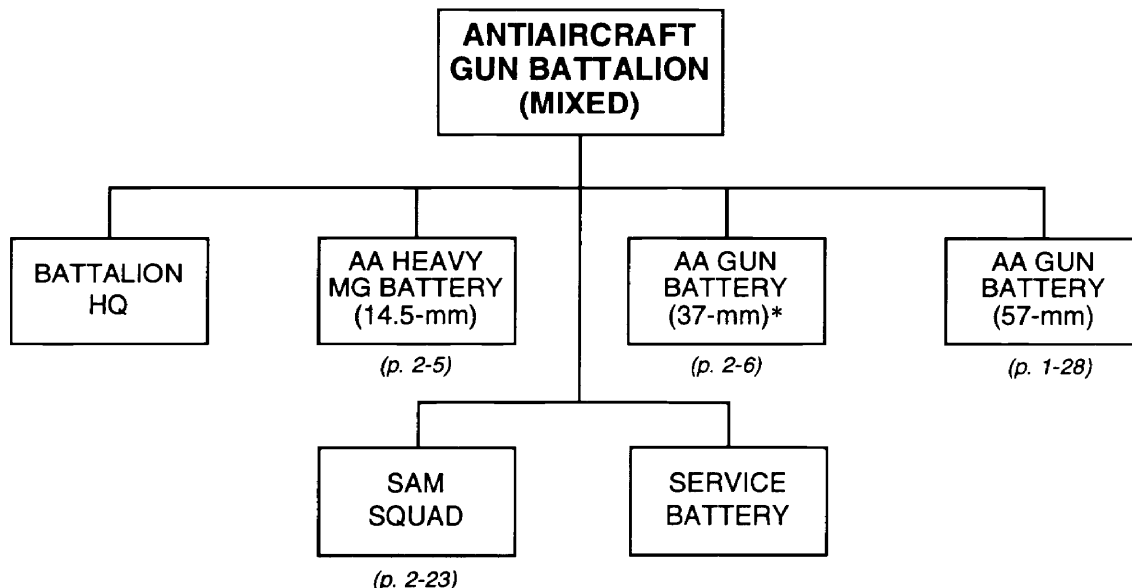

**PRINCIPAL ITEMS OF EQUIPMENT**

| <u>Equipment</u>                        | <u>Total</u> | <u>Equipment</u>                                     | <u>Total</u> |
|---|--------------|--|--------------|
| 14.5-mm AA HMG, ZPU-2<br>or ZPU-4 ..... | 6            | Trailer, Kitchen .....                               | 3            |
| 37-mm AA Gun, M1939* .....              | 6            | Trailer, POL (1,200-Liter) .....                     | 3            |
| 57-mm AA Gun, 57-mm .....               | 6            | Trailer, Water (900-Liter) .....                     | 3            |
| SAM, Shoulder-Fired .....               | 6            | Radar, Fire-Control,<br>FLAP WHEEL or FIRE CAN ..... | 1            |
| Truck, Utility .....                    | 4            | Radios:  |              |
| Truck, Light .....                      | 2            | VHF, Manpack, Low-Power .....                        | 18           |
| Truck, Medium .....                     | 39           | VHF, Portable, Very-Low-Power .....                  | 6            |
| Truck, POL (5,000-Liter) .....          | 3            | HF, Manpack, Low-Power .....                         | 1            |
| Van, Maintenance .....                  | 1            | HF/VHF, Vehicle Mount,<br>Medium-Power .....         | 1            |
| Van, Radar .....                        | 1            | HF/VHF, Vehicle Mount,<br>High-Power .....           | 1            |
| Van, Signal .....                       | 1            | Warning Receiver .....                               | 4            |
| Trailer, Cargo, 2-Axle .....            | 12           |  |              |
| Trailer, Generator .....                | 2            |  |              |

**NOTE:** Some mixed AA gun battalions may have two batteries of 14.5-mm AA HMG and only one battery of larger-caliber AA guns.

**FOOTNOTE:** \* Some mixed AA gun battalions may have a battery of six 23-mm AA gun ZU-23 instead of the 37-mm M1939.

**Antiaircraft Heavy Machinegun Battery (14.5-mm), AA Gun Bn (Mixed)  
or Abn Inf Bde or SAM Bn (SA-2 and SA-3)**

---

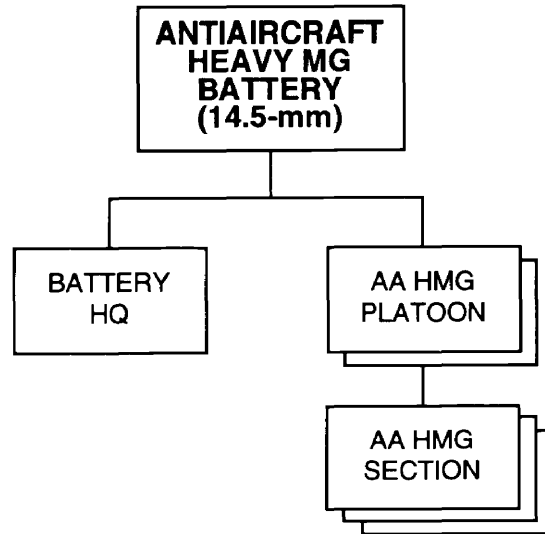

**PRINCIPAL ITEMS OF EQUIPMENT**

| <u>Equipment</u>                    | <u>Total</u> |
|-------------------------------------|--------------|
| 14.5-mm AA HMG, ZPU-2 or ZPU-4..... | 6            |
| Truck, Utility .....                | 1            |
| Truck, Medium .....                 | 10           |

| <u>Equipment</u>                    | <u>Total</u> |
|-------------------------------------|--------------|
| Radios:                             |              |
| VHF, Manpack, Low-Power .....       | 6            |
| VHF, Portable, Very-Low-Power ..... | 1            |
| Warning Receiver .....              | 1            |

Antiaircraft Gun Battery (37-mm),  
AA Gun Bn (Mixed)

---

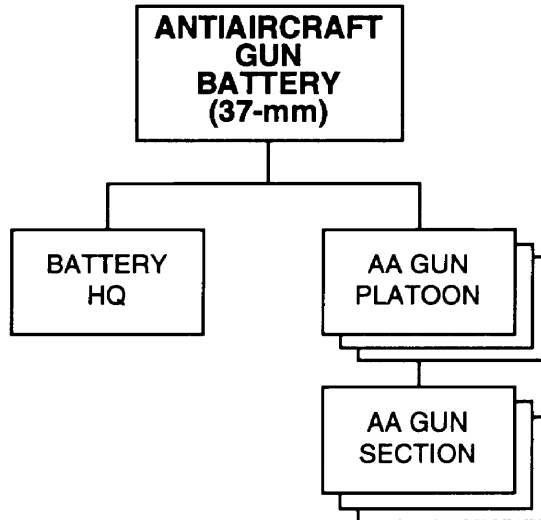

**PRINCIPAL ITEMS OF EQUIPMENT**

| <u>Equipment</u>           | <u>Total</u> | <u>Equipment</u>                    | <u>Total</u> |
|----------------------------|--------------|-------------------------------------|--------------|
| 37-mm AA Gun, M1939* ..... | 6            | Radios:                             |              |
| Truck, Utility .....       | 1            | VHF, Manpack, Low-Power .....       | 6            |
| Truck, Medium .....        | 10           | VHF, Portable, Very-Low-Power ..... | 1            |
|                            |              | Warning Receiver .....              | 1            |

**FOOTNOTE:** \* The 23-mm AA gun ZU-23 may replace the 37-mm M1939 in this battery.

Maintenance Battalion, Inf Div or MD

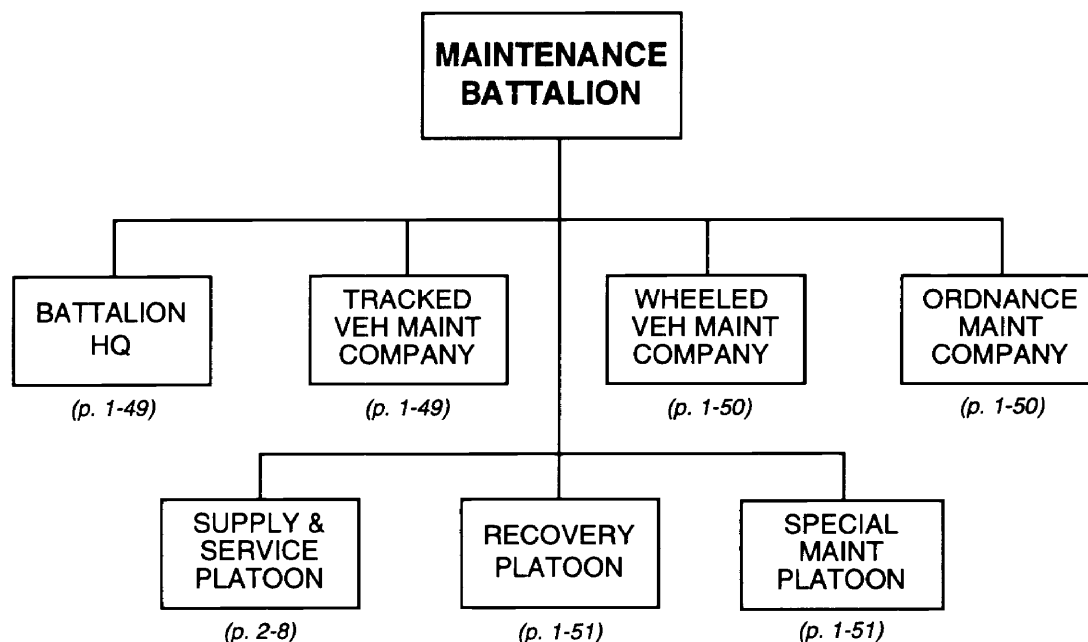

PRINCIPAL ITEMS OF EQUIPMENT

| <u>Equipment</u>                  | <u>Total</u> | <u>Equipment</u>                 | <u>Total</u> |
|-----------------------------------|--------------|----------------------------------|--------------|
| ATRL, RPG-18/22.....              | 11           | Trailer, Cargo, 2-Axle.....      | 13           |
| Truck, Utility .....              | 5            | Trailer, Generator.....          | 7            |
| Truck, Light .....                | 4            | Trailer, Kitchen.....            | 3            |
| Truck, Medium .....               | 20           | Trailer, POL (4,200-Liter) ..... | 3            |
| Truck, Crane .....                | 3            | Trailer, Water (900-Liter) ..... | 1            |
| Truck, POL (5,000-Liter).....     | 4            | Tractor-Trailer, Lowboy .....    | 2            |
| Truck, Recovery.....              | 2            | Radios:                          |              |
| Truck, Water (2,000-Liter) .....  | 1            | VHF, Manpack, Low-Power.....     | 5            |
| Van, Light .....                  | 3            | VHF, Vehicle Mount,              |              |
| Van, Maintenance .....            | 40           | Medium-Power .....               | 4            |
| Van, Signal.....                  | 1            | HF/VHF, Vehicle Mount,           |              |
| Ambulance .....                   | 1            | Medium-Power .....               | 1            |
| Tracked Amphibian, K-61/PTS ..... | 1            | HF, Vehicle Mount,               |              |
| Tractor, Artillery, AT-S .....    | 1            | Medium-Power .....               | 1            |
| Motorcycle .....                  | 3            | Warning Receiver .....           | 1            |
| Armored Recovery Vehicle .....    | 2            |                                  |              |



Supply and Service Platoon,  
Maint Bn, Inf Div or MD \_\_\_\_\_

|   |
|---|
| <b>SUPPLY &amp;<br/>SERVICE<br/>PLATOON</b> |
|---|

**PRINCIPAL ITEMS OF EQUIPMENT**

| <b><u>Equipment</u></b>          | <b><u>Total</u></b> | <b><u>Equipment</u></b>              | <b><u>Total</u></b> |
|----------------------------------|---------------------|--------------------------------------|---------------------|
| ATRL, RPG-18/22.....             | 1                   | Trailer, Cargo, 2-Axle.....          | 4                   |
| Truck, Light .....               | 4                   | Trailer, Kitchen.....                | 3                   |
| Truck, Medium .....              | 10                  | Trailer, POL (4,200-Liter) .....     | 4                   |
| Truck, POL (5,000-Liter).....    | 4                   | Trailer, Water (900-Liter) .....     | 1                   |
| Truck, Water (2,000-Liter) ..... | 1                   | Radio, VHF, Manpack, Low-Power ..... | 1                   |
| Ambulance .....                  | 1                   |                                      |                     |

## Mechanized Infantry Division

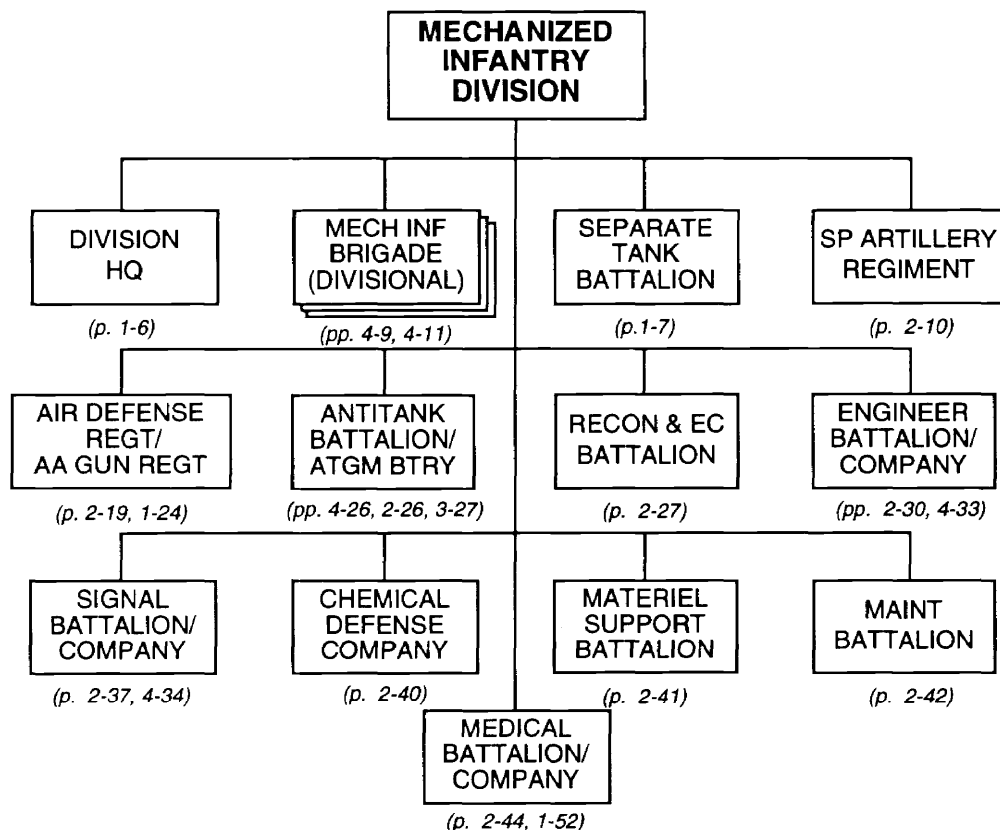

### NOTES:

1. The basic maneuver units in this division are three mechanized infantry brigades (divisional). The normal mix is two APC-equipped brigades and one IFV-equipped brigade, or vice versa. These divisional brigades differ structurally from their separate counterparts normally found within military districts. In addition to its mechanized infantry brigades, this division normally has a separate tank battalion.
2. Most mechanized infantry divisions have battalion-sized antitank, engineer, signal, and medical units. However, some not-so-well-equipped mechanized infantry divisions may have only an ATGM battery and company-sized engineer, signal, and medical units.
3. Mechanized and motorized infantry divisions are normally the basic maneuver formations of an expeditionary army (see p. 5-5). Such an army, mobilized in one military region to conduct large-scale offensive operations, may include divisions resubordinated from other regions or districts.
4. Divisions can be either standing or mobilized from the reserves. Standing divisions may exist in districts along an international border, in districts that contain historically threatened avenues of approach, or around critical cities/facilities. Standing divisions have the assets shown above, even before mobilization. Divisions mobilized from the reserves may draw the combat support and combat service support assets shown above from reserves or receive them from the national asset pool. The commander of the district in which a division is garrisoned or mobilized is also the division commander, as long as the division remains in that district.
5. Mechanized infantry divisions are less common than motorized infantry divisions.

Self-Propelled Artillery Regiment, Mech Inf Div  
 or MD or Army or CDF or National

---

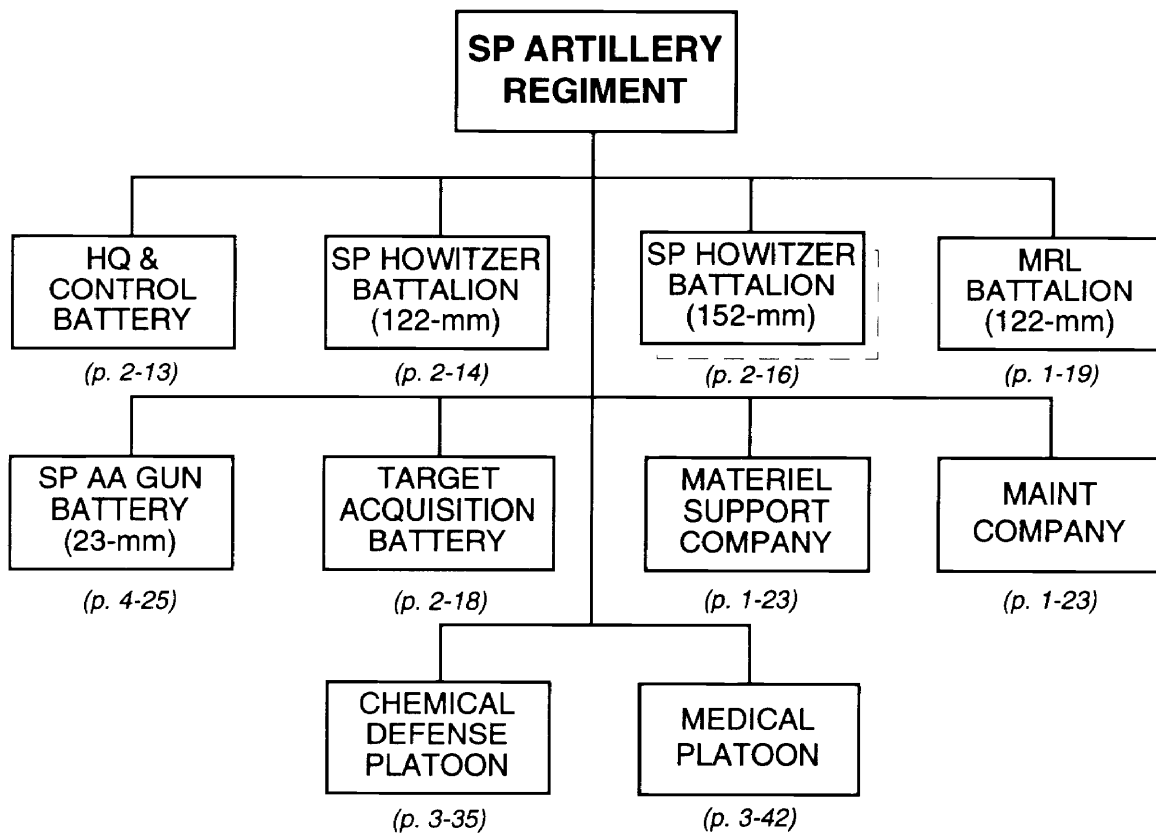

**NOTES:**

1. Divisions always have regiments with only one of each type of battalion. The equipment listing below does not include a second gun-howitzer battalion.
2. Most regiments have one of each type of battalion: howitzer, gun-howitzer, and MRL. Regiments with two 152-mm gun-howitzer battalions are more common in districts with more than three maneuver brigades.

(continued)

**Self-Propelled Artillery Regiment, Mech Inf Div  
or MD or Army or CDF or National (continued)**

| <i>Principal Items of Equipment</i> | <i>HQ &amp; Control Btry</i> | <i>SP Howitzer Bn (122-mm)</i> | <i>SP Howitzer Bn (152-mm)</i> | <i>MRL Bn (122-mm)</i> | <i>SP AA Gun Btry (23-mm)</i> | <i>Target Acquisition Btry</i> | <i>Material Support Co</i> | <i>Maintenance Co</i> | <i>Chemical Defense Plt</i> | <i>Medical Plt</i> | <i>TOTAL</i> |
|-------------------------------------|------------------------------|--------------------------------|--------------------------------|------------------------|-------------------------------|--------------------------------|----------------------------|-----------------------|-----------------------------|--------------------|--------------|
| <b>ARMORED VEHICLES</b>             |                              |                                |                                |                        |                               |                                |                            |                       |                             |                    |              |
| APC, BTR-60/70/80                   | 1                            |                                |                                |                        |                               |                                |                            |                       |                             |                    | 1            |
| APC, BTR-60 (PU-12)                 |                              |                                |                                |                        | 1                             |                                |                            |                       |                             |                    | 1            |
| ACV, BTR (R-145BM)                  | 2                            |                                |                                |                        |                               | 1                              |                            |                       |                             |                    | 3            |
| Chem Recon Vehicle, BRDM-2RKh/RKhM  | 1                            |                                |                                |                        |                               |                                |                            | 3                     |                             |                    | 4            |
| Mobile Recon Post, PRP-3/4*         | 1                            | 1                              | 1                              |                        |                               | 1                              |                            |                       |                             |                    | 4            |
| APC, Radar, MT-LB (SNAR-10)**       |                              |                                |                                |                        |                               | 1                              |                            |                       |                             |                    | 1            |
| APC, Radar, MT-LB (ARK-1)***        |                              |                                |                                |                        |                               | 1                              |                            |                       |                             |                    | 1            |
| ACRV, 1V13/1V13M/1V22               |                              | 3                              | 3                              |                        |                               |                                |                            |                       |                             |                    | 6            |
| ACRV, 1V14/1V14M/1V23               |                              | 3                              | 3                              |                        |                               |                                |                            |                       |                             |                    | 6            |
| ACRV, 1V15/1V15M/1V24               |                              | 1                              | 1                              |                        |                               |                                |                            |                       |                             |                    | 2            |
| ACRV, 1V16/1V16M/1V25               |                              | 1                              | 1                              |                        |                               |                                |                            |                       |                             |                    | 2            |
| ACRV, 1V18                          |                              |                                |                                | 3                      |                               |                                |                            |                       |                             |                    | 3            |
| ACRV, 1V19                          |                              |                                |                                | 1                      |                               |                                |                            |                       |                             |                    | 1            |
| <b>WEAPONS</b>                      |                              |                                |                                |                        |                               |                                |                            |                       |                             |                    |              |
| 122-mm SP Howitzer, 2S1             |                              | 18                             |                                |                        |                               |                                |                            |                       |                             |                    | 18           |
| 152-mm SP Howitzer, 2S3             |                              |                                | 18                             |                        |                               |                                |                            |                       |                             |                    | 18           |
| 122-mm MRL, BM-21                   |                              |                                |                                | 18                     |                               |                                |                            |                       |                             |                    | 18           |
| 23-mm SP AA Gun, ZSU-23-4****       |                              |                                |                                |                        | 8                             |                                |                            |                       |                             |                    | 8            |
| ATGL, RPG-7V                        | 4                            | 6                              | 6                              | 6                      |                               |                                |                            | 4                     |                             |                    | 26           |
| SAM, Shoulder-Fired                 | 3                            | 18                             | 18                             | 18                     |                               |                                |                            |                       |                             |                    | 57           |
| <b>TRUCKS</b>                       |                              |                                |                                |                        |                               |                                |                            |                       |                             |                    |              |
| ACRV, 1V110 (Battery FDC)           |                              |                                |                                | 3                      |                               |                                |                            |                       |                             |                    | 3            |
| ACRV, 1V111 (Battalion FDC)         |                              |                                |                                | 1                      |                               |                                |                            |                       |                             |                    | 1            |
| Truck, Utility                      | 6                            |                                |                                | 1                      |                               |                                | 1                          | 1                     |                             |                    | 9            |
| Truck, Light                        | 2                            | 4                              |                                |                        | 1                             | 2                              | 1                          |                       |                             | 1                  | 11           |
| Truck, Medium                       | 1                            | 14                             | 20                             | 37                     | 4                             | 3                              | 32                         | 3                     |                             | 2                  | 116          |
| Truck, Decon, ARS-12U/14            |                              |                                |                                |                        |                               |                                |                            |                       | 3                           |                    | 3            |
| Truck, Decon, DDA-53/66             |                              |                                |                                |                        |                               |                                |                            |                       | 1                           | 1                  | 2            |
| Truck, Crane                        |                              |                                |                                |                        |                               |                                |                            | 1                     |                             |                    | 1            |
| Truck, POL (5,000-L)                |                              | 2                              | 4                              | 3                      |                               |                                | 6                          |                       |                             |                    | 15           |
| Truck, Recovery                     |                              |                                |                                |                        |                               |                                |                            | 1                     |                             |                    | 1            |
| Truck, Water (2,000-L)              |                              |                                |                                |                        |                               |                                |                            |                       | 2                           |                    | 2            |
| Van, Hospital                       |                              |                                |                                |                        |                               |                                |                            |                       |                             | 1                  | 1            |
| Van, Maintenance                    | 1                            | 2                              | 2                              | 3                      |                               | 4                              | 2                          | 6                     |                             |                    | 20           |
| Van, Signal                         | 2                            | 4                              | 4                              | 4                      |                               |                                |                            |                       |                             |                    | 14           |
| Van, Survey                         |                              |                                |                                |                        |                               | 1                              |                            |                       |                             |                    | 1            |
| Ambulance                           |                              | 1                              | 1                              | 1                      |                               |                                |                            |                       |                             | 4                  | 7            |

**FOOTNOTES:**

- \* This system includes the SMALL FRED or TALL MIKE battlefield surveillance radar.
- \*\* This system includes the BIG FRED battlefield surveillance radar.
- \*\*\* This system includes the RICE BAG countermortar/counterbattery radar.
- \*\*\*\* This system includes the GUN DISH fire control radar.

(continued)

Self-Propelled Artillery Regiment, Mech Inf Div  
or MD or Army or CDF or National (continued)

| <i>Principal Items of Equipment</i> | <i>HQ &amp; Control Btry</i> | <i>SP Howitzer Bn (122-mm)</i> | <i>SP Howitzer Bn (152-mm)</i> | <i>MRL Bn (122-mm)</i> | <i>SP AA Gun Btry (23-mm)</i> | <i>Target Acquisition Btry</i> | <i>Materiel Support Co</i> | <i>Maintenance Co</i> | <i>Chemical Defense Plt</i> | <i>Medical Plt</i> | <i>TOTAL</i> |
|-------------------------------------|------------------------------|--------------------------------|--------------------------------|------------------------|-------------------------------|--------------------------------|----------------------------|-----------------------|-----------------------------|--------------------|--------------|
| <b>TRAILERS</b>                     |                              |                                |                                |                        |                               |                                |                            |                       |                             |                    |              |
| Trailer, Cargo, 1-Axle              |                              |                                |                                |                        |                               | 1                              |                            |                       |                             |                    | 1            |
| Trailer, Cargo, 2-Axle              | 1                            | 16                             | 17                             | 27                     |                               |                                | 20                         | 3                     |                             |                    | 84           |
| Trailer, Generator                  | 2                            | 2                              |                                | 2                      | 2                             | 2                              |                            | 2                     |                             |                    | 12           |
| Trailer, Kitchen                    | 1                            | 3                              | 3                              | 3                      |                               | 1                              |                            |                       |                             | 1                  | 12           |
| Trailer, POL (4,200-L)              |                              | 2                              | 4                              | 3                      |                               |                                | 6                          |                       |                             |                    | 15           |
| Trailer, Water (900-/1,200-L)       | 1                            | 1                              | 1                              | 1                      |                               | 1                              | 2                          |                       | 2                           | 1                  | 10           |
| Trailer, Welding                    |                              |                                |                                |                        |                               |                                |                            | 1                     |                             |                    | 1            |
| <b>RADIOS</b>                       |                              |                                |                                |                        |                               |                                |                            |                       |                             |                    |              |
| VHF, Manpack, Low-Power             | 6                            | 10                             | 10                             | 18                     |                               | 13                             | 1                          | 1                     |                             | 1                  | 60           |
| VHF, Portable, Low-Power            | 1                            |                                |                                |                        | 1                             |                                |                            |                       |                             |                    | 2            |
| VHF, Vehicle Mount, Medium-Power    | 5                            | 27                             | 27                             | 6                      | 9                             | 4                              |                            |                       | 3                           |                    | 81           |
| HF, Manpack, Low-Power              | 1                            |                                |                                |                        |                               |                                |                            |                       | 1                           |                    | 2            |
| HF, Vehicle Mount, Medium-Power     | 5                            |                                |                                |                        |                               |                                |                            |                       |                             |                    | 5            |
| HF/VHF, Vehicle Mount, Med-Power    | 3                            | 4                              | 4                              | 6                      |                               |                                |                            |                       |                             |                    | 17           |
| HF/VHF, Vehicle Mount, High-Power   | 1                            |                                |                                |                        |                               |                                |                            |                       |                             |                    | 1            |
| Radio Relay, VHF/UHF                | 1                            |                                |                                |                        |                               |                                |                            |                       |                             |                    | 1            |
| Warning Receiver                    | 1                            | 2                              | 2                              | 1                      | 3                             | 1                              |                            |                       |                             |                    | 10           |
| <b>MISCELLANEOUS</b>                |                              |                                |                                |                        |                               |                                |                            |                       |                             |                    |              |
| Rangefinder, Laser, SAGE GLOSS      | 1                            | 4                              | 4                              |                        |                               | 2                              |                            |                       |                             |                    | 11           |
| Sound-Ranging Set                   |                              |                                |                                |                        |                               | 1                              |                            |                       |                             |                    | 1            |

**Headquarters and Control Battery,  
SP Arty Regt or Arty Bde**

---

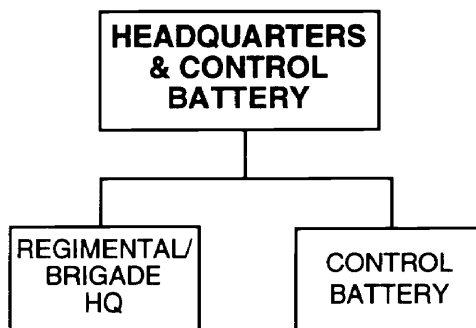

**PRINCIPAL ITEMS OF EQUIPMENT**

| <u>Equipment</u>                  | <u>Total</u> | <u>Equipment</u>                    | <u>Total</u> |
|-----------------------------------|--------------|-------------------------------------|--------------|
| ATGL, RPG-7V .....                | 4            | Rangefinder, Laser, SAGE GLOSS..... | 1            |
| Mobile Recon Post, PRP-3/4* ..... | 1            | Radios:                             |              |
| APC, BTR-60/70/80 .....           | 1            | VHF, Manpack, Low-Power .....       | 6            |
| SAM, Shoulder-Fired.....          | 3            | VHF, Portable, Low-Power or         |              |
| ACV, BTR (R-145BM) .....          | 2            | Very-Low-Power .....                | 1            |
| Truck, Utility .....              | 6            | VHF, Vehicle Mount,                 |              |
| Truck, Light .....                | 2            | Medium-Power .....                  | 5            |
| Truck, Medium .....               | 1            | HF, Manpack, Low-Power.....         | 1            |
| Chemical Recon Vehicle,           |              | HF, Vehicle Mount,                  |              |
| BRDM-2RKh/RKhM .....              | 1            | Medium-Power .....                  | 5            |
| Van, Signal.....                  | 2            | HF/VHF, Vehicle Mount,              |              |
| Van, Maintenance .....            | 1            | High-Power .....                    | 1            |
| Trailer, Cargo, 2-Axle.....       | 1            | HF/VHF, Vehicle Mount,              |              |
| Trailer, Generator.....           | 2            | Medium-Power .....                  | 3            |
| Trailer, Kitchen.....             | 1            | Radio Relay, VHF/UHF.....           | 1            |
| Trailer, Water (900-Liter) .....  | 1            | Warning Receiver .....              | 1            |

**FOOTNOTE:** \* This system includes the SMALL FRED or TALL MIKE battlefield surveillance radar.

**122-mm Self-Propelled Howitzer Battalion, Mech Inf Bde  
(Sep and Div) and Tank Bale, or SP Arty Regt \_\_\_\_\_**

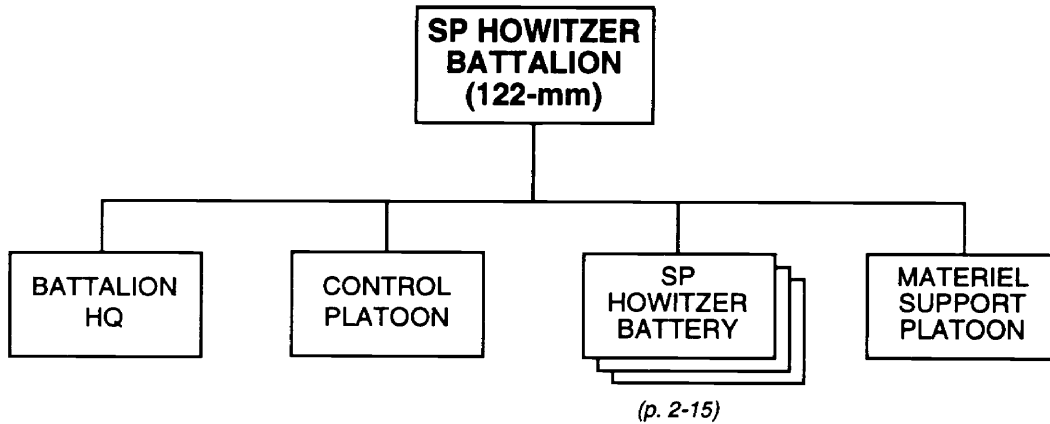

**PRINCIPAL ITEMS OF EQUIPMENT**

| <u>Equipment</u>                      | <u>Total</u> |
|---------------------------------------|--------------|
| 122-mm SP Howitzer, 2S1 .....         | 18           |
| ACRV, 1V13/1V13M/1V22 (Btry FDC) .... | 3            |
| ACRV, 1V14/1V14M/1V23 (Btry COP) .... | 3            |
| ACRV, 1V15/1V15M/1V24 (Bn COP).....   | 1            |
| ACRV, 1V16/1V16M/1V25 (Bn FDC).....   | 1            |
| Mobile Recon Post, PRP-3/4* .....     | 1            |
| 7.62-mm GP MG, PKM.....               | 18           |
| SAM, Shoulder-Fired.....              | 18           |
| ATGL, RPG-7V.....                     | 6            |
| Truck, Light .....                    | 4            |
| Truck, Medium .....                   | 14           |
| Truck, POL (5,000-Liter).....         | 2            |
| Van, Maintenance .....                | 2            |
| Van, Signal.....                      | 4            |

| <u>Equipment</u>                     | <u>Total</u> |
|--------------------------------------|--------------|
| Ambulance .....                      | 1            |
| Trailer, Cargo, 2-Axle.....          | 16           |
| Trailer, Generator.....              | 2            |
| Trailer, Kitchen.....                | 3            |
| Trailer, POL (4,200-Liter) .....     | 2            |
| Trailer, Water (1,200-Liter) .....   | 1            |
| Rangefinder, Laser, SAGE GLOSS ..... | 4            |
| Radios:                              |              |
| VHF, Manpack, Low-Power.....         | 10           |
| VHF, Vehicle Mount,                  |              |
| Medium-Power .....                   | 27           |
| HF/VHF, Vehicle Mount,               |              |
| Medium-Power .....                   | 4            |
| Warning Receiver .....               | 2            |

**FOOTNOTE:** \* This system includes the SMALL FRED or TALL MIKE battlefield surveillance radar.

**122-mm Self-Propelled Howitzer Battery,  
122-mm SP Howitzer Bn**

---

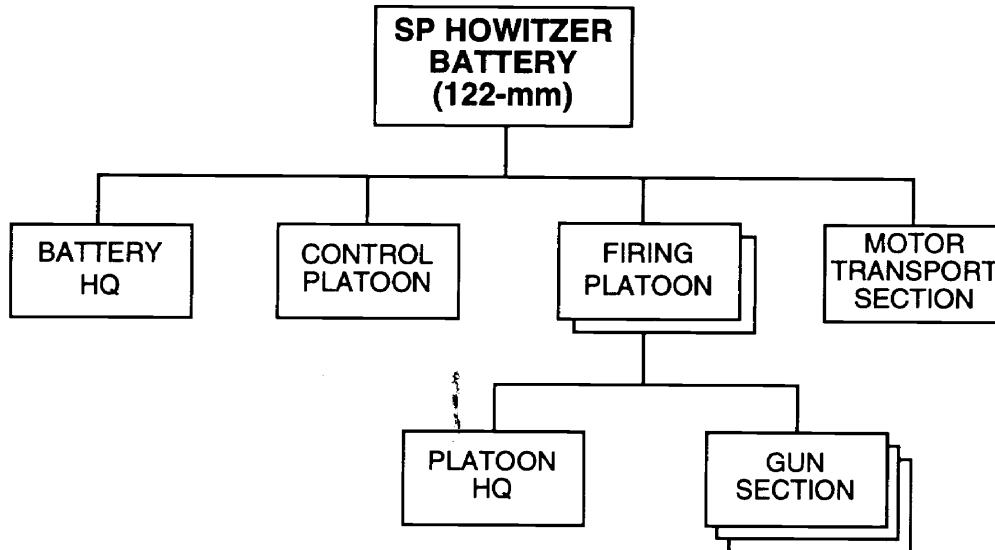

**PRINCIPAL ITEMS OF EQUIPMENT**

| <u>Equipment</u>                      | <u>Total</u> | <u>Equipment</u>                     | <u>Total</u> |
|---------------------------------------|--------------|--------------------------------------|--------------|
| 122-mm SP Howitzer, 2S1 .....         | 6            | Trailer, Cargo, 2-Axle.....          | 3            |
| ACRV, 1V13/1V13M/1V22 (Btry FDC) .... | 1            | Rangefinder, Laser, SAGE GLOSS ..... | 1            |
| ACRV, 1V14/1V14M/1V23 (Btry COP) .... | 1            | Radios:                              |              |
| 7.62-mm GP MG, PKM.....               | 6            | VHF, Manpack, Low-Power.....         | 2            |
| SAM, Shoulder-Fired.....              | 6            | VHF, Vehicle Mount,                  |              |
| ATGL, RPG-7V .....                    | 2            | Medium-Power .....                   | 8            |
| Truck, Medium .....                   | 3            | HF/VHF, Vehicle Mount,               |              |
| Van, Signal.....                      | 1            | Medium-Power .....                   | 1            |



**152-mm Self-Propelled Howitzer Battalion,  
SP Arty Regt**

---

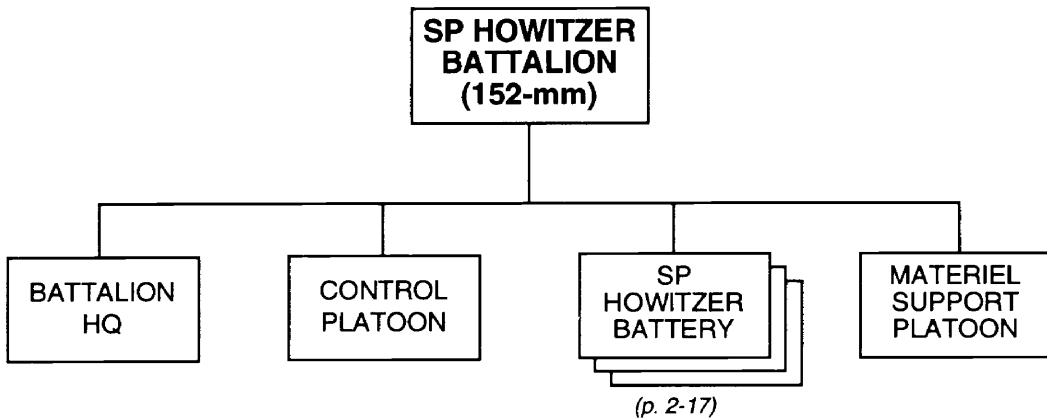

**PRINCIPAL ITEMS OF EQUIPMENT**

| <u>Equipment</u>                      | <u>Total</u> | <u>Equipment</u>                     | <u>Total</u> |
|---------------------------------------|--------------|--------------------------------------|--------------|
| 152-mm SP Howitzer, 2S3 .....         | 18           | Ambulance .....                      | 1            |
| ACRV, 1V13/1V13M/1V22 (Btry FDC) .... | 3            | Trailer, Cargo, 2-Axle.....          | 17           |
| ACRV, 1V14/1V14M/1V23 (Btry COP) .... | 3            | Trailer, Kitchen.....                | 3            |
| ACRV, 1V15/1V15M/1V24 (Bn COP).....   | 1            | Trailer, POL (4,200-Liter) .....     | 4            |
| ACRV, 1V16/1V16M/1V25 (Bn FDC).....   | 1            | Trailer, Water (1,200-Liter) .....   | 1            |
| Mobile Recon Post, PRP-3/4* .....     | 1            | Rangefinder, Laser, SAGE GLOSS ..... | 4            |
| 7.62-mm GP MG, PKM.....               | 18           | Radios:                              |              |
| SAM, Shoulder-Fired.....              | 18           | VHF, Manpack, Low-Power.....         | 10           |
| ATGL, RPG-7V.....                     | 6            | VHF, Vehicle Mount,                  |              |
| Truck, Medium .....                   | 20           | Medium-Power .....                   | 27           |
| Truck, POL (5,000-Liter).....         | 4            | HF/VHF, Vehicle Mount,               |              |
| Van, Maintenance .....                | 2            | Medium-Power .....                   | 4            |
| Van, Signal.....                      | 4            | Warning Receiver .....               | 2            |

**FOOTNOTE:** \* This system includes the SMALL FRED or TALL MIKE battlefield surveillance radar.

**152-mm Self-Propelled Howitzer Battery,  
152-mm SP Howitzer Bn**

---

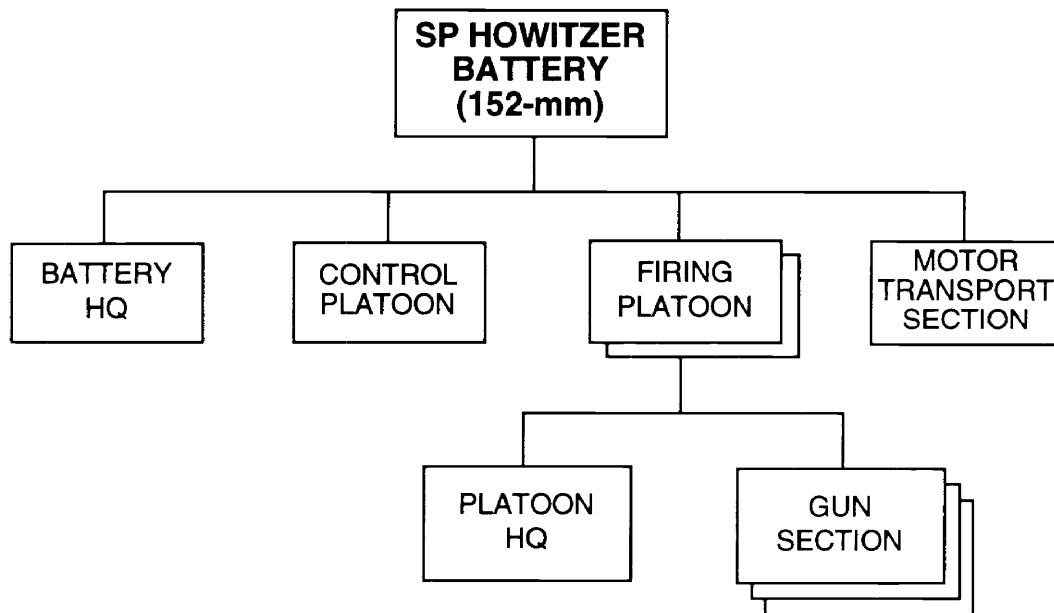

**PRINCIPAL ITEMS OF EQUIPMENT**

| <u>Equipment</u>                      | <u>Total</u> | <u>Equipment</u>                     | <u>Total</u> |
|---------------------------------------|--------------|--------------------------------------|--------------|
| 152-mm SP Howitzer, 2S3 .....         | 6            | Trailer, Cargo, 2-Axle.....          | 3            |
| ACRV, 1V13/1V13M/1V22 (Btry FDC) .... | 1            | Rangefinder, Laser, SAGE GLOSS ..... | 1            |
| ACRV, 1V14/1V14M/1V23 (Btry COP) .... | 1            | Radios:                              |              |
| 7.62-mm GP MG, PKM.....               | 6            | VHF, Manpack, Low-Power.....         | 2            |
| SAM, Shoulder-Fired.....              | 6            | VHF, Vehicle Mount,                  |              |
| ATGL, RPG-7V.....                     | 2            | Medium-Power .....                   | 8            |
| Truck, Medium .....                   | 3            | HF/VHF, Vehicle Mount,               |              |
| Van, Signal.....                      | 1            | Medium-Power .....                   | 1            |

Target Acquisition Battery, SP Arty Regt  
or Arty Bde \_\_\_\_\_

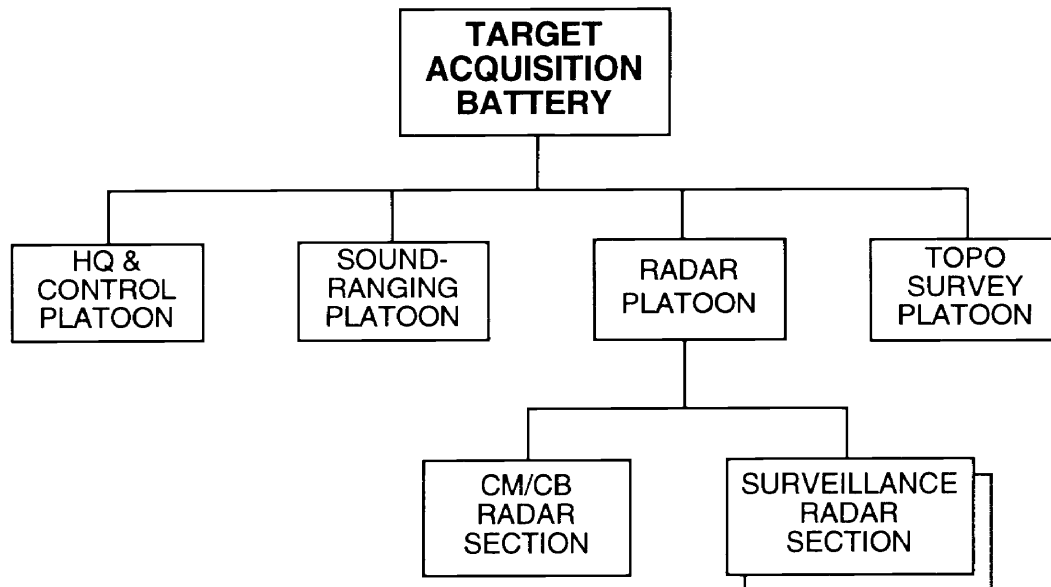

**PRINCIPAL ITEMS OF EQUIPMENT**

| <u>Equipment</u>                   | <u>Total</u> | <u>Equipment</u>                     | <u>Total</u> |
|------------------------------------|--------------|--------------------------------------|--------------|
| ACV, BTR (R-145BM) .....           | 1            | Trailer, Kitchen.....                | 1            |
| APC, Radar, MT-LB (SNAR 10)* ..... | 1            | Trailer, Water (900-Liter) .....     | 1            |
| Mobile Recon Post, PRP-3/4** ..... | 1            | Rangefinder, Laser, SAGE GLOSS ..... | 2            |
| APC, Radar, MT-LB (ARK-1)*** ..... | 1            | Sound-Ranging Set .....              | 1            |
| Truck, Light .....                 | 2            | Radios:                              |              |
| Truck, Medium .....                | 3            | VHF, Manpack, Low-Power.....         | 13           |
| Van, Maintenance .....             | 4            | VHF, Vehicle Mount,                  |              |
| Van, Survey.....                   | 1            | Medium-Power .....                   | 4            |
| Trailer, Cargo, 1-Axle.....        | 1            | Warning Receiver .....               | 1            |
| Trailer, Generator.....            | 2            |                                      |              |

**FOOTNOTES:**

- \* This system includes the BIG FRED battlefield surveillance radar.
- \*\* This system includes the SMALL FRED or TALL MIKE battlefield surveillance radar.
- \*\*\* This system includes the RICE BAG countermortar/counterbattery radar.

**Air Defense Regiment, Mech Inf Div or MD or  
Army or CDF or ADC**

---

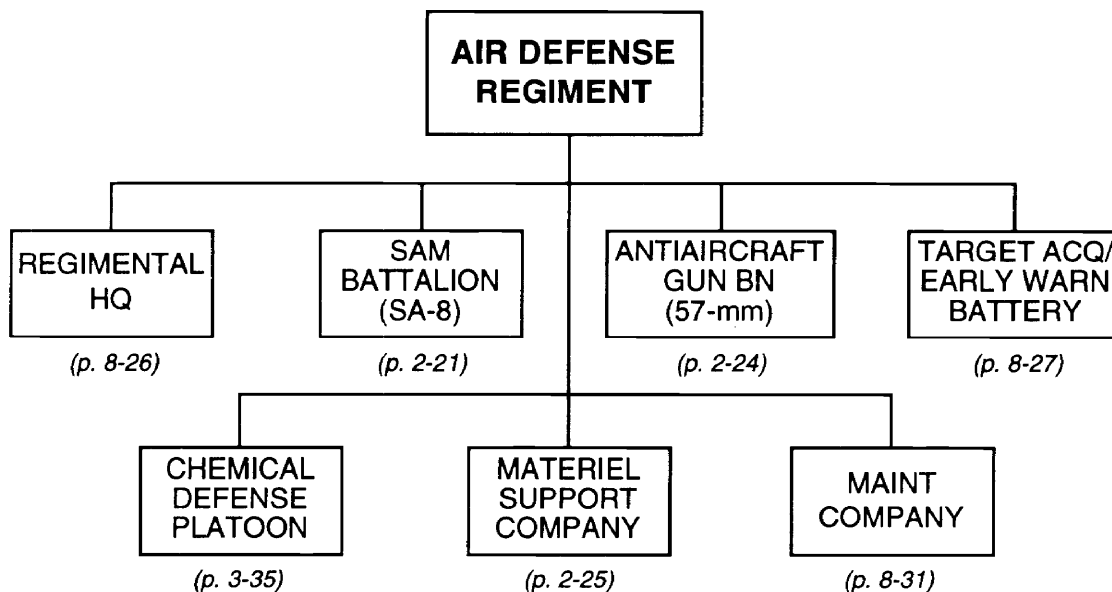

**(continued)**

Air Defense Regiment, Mech Inf Div or MD or Army or CDF or ADC (continued)

| Principal Items of Equipment       | Regimental HQ | SAM Bn (SA-8) | AA Gun Bn (57-mm) | Target Acquisition /Early Warning Btry | Chemical Defense Plt | Materiel Support Co | Maintenance Co | TOTAL |
|------------------------------------|---------------|---------------|-------------------|--|----------------------|---------------------|----------------|-------|
| <b>ARMORED VEHICLES</b>            |               |               |                   |  |                      |                     |                |       |
| APC, BTR-60 (PU-12)                | 1             | 3             | 1                 |  |                      |                     |                | 5     |
| Chem Recon Vehicle, BRDM-2RKh/RKhM |               |               |                   |  | 3                    |                     |                | 3     |
| Tgt Acq Radar Vehicle              |               |               |                   | 2                                      |                      |                     |                | 2     |
| <b>WEAPONS</b>                     |               |               |                   |  |                      |                     |                |       |
| 57-mm AA Gun, S-60                 |               |               | 18                |  |                      |                     |                | 18    |
| SAM, SA-8/GECKO TELAR*             |               | 8             |                   |  |                      |                     |                | 8     |
| SAM, Shoulder-Fired                | 3             | 12            | 12                |  |                      |                     |                | 27    |
| <b>TRUCKS</b>                      |               |               |                   |  |                      |                     |                |       |
| Truck, Utility                     | 1             | 2             | 7                 | 3                                      |                      | 3                   | 1              | 17    |
| Truck, Light                       | 3             | 7             | 7                 | 1                                      |                      | 2                   | 1              | 21    |
| Truck, Medium                      |               | 19            | 36                |  |                      | 25                  | 3              | 83    |
| Truck, Decon, ARS-12U/14           |               |               |                   |  | 3                    |                     |                | 3     |
| Truck, Decon, DDA-53/66            |               |               |                   |  | 1                    |                     |                | 1     |
| Truck, Crane                       |               | 1             | 1                 |  |                      |                     |                | 2     |
| Truck, POL (5,000-L)               |               | 2             | 4                 |  |                      | 3                   |                | 9     |
| Truck, Water (2,000-L)             |               |               | 1                 |  | 2                    | 2                   |                | 5     |
| Van Computer                       |               |               |                   | 1                                      |                      |                     |                | 1     |
| Van, Maintenance                   |               | 5             | 3                 | 1                                      |                      | 2                   | 8              | 19    |
| Van, Medium                        | 2             | 2             |                   |  |                      |                     |                | 4     |
| Van, Missile Testing               |               | 2             |                   |  |                      |                     |                | 2     |
| Van, Radar                         |               |               | 4                 | 1                                      |                      |                     |                | 5     |
| Van, Signal                        | 4             | 1             | 1                 |  |                      |                     |                | 6     |
| Ambulance                          | 2             |               |                   |  |                      |                     |                | 2     |
| <b>TRAILERS</b>                    |               |               |                   |  |                      |                     |                |       |
| Trailer, Cargo, 1-Axle             |               | 1             |                   |  |                      |                     |                | 1     |
| Trailer, Cargo, 2-Axle             |               | 5             | 3                 | 1                                      |                      | 5                   | 3              | 17    |
| Trailer, Generator                 | 2             | 6             | 5                 |  |                      | 2                   | 7              | 22    |
| Trailer, Kitchen                   | 1             | 4             | 4                 | 1                                      |                      | 3                   | 1              | 14    |
| Trailer, POL (1,200-L)             |               |               | 4                 |  |                      |                     |                | 4     |
| Trailer, POL (4,200-L)             |               | 2             | 2                 |  |                      | 3                   |                | 7     |
| Trailer, Van                       | 4             | 4             |                   | 1                                      |                      |                     |                | 9     |
| Trailer, Water (900-/1,200-L)      |               | 2             | 4                 |  | 2                    | 1                   | 1              | 10    |
| <b>RADARS</b>                      |               |               |                   |  |                      |                     |                |       |
| Aer. Surv./Tgt Acq, LONG TRACK     |               |               |                   | 2                                      |                      |                     |                | 2     |
| Aer. Surv./Tgt Acq, FLAT FACE      |               |               | 1                 |  |                      |                     |                | 1     |
| Radar, Fire Control, FLAP WHEEL    |               |               | 3                 |  |                      |                     |                | 3     |
| Radar, Height Finding, THIN SKIN   |               |               |                   | 1                                      |                      |                     |                | 1     |
| <b>RADIOS</b>                      |               |               |                   |  |                      |                     |                |       |
| VHF, Manpack, Low-Power            | 1             | 6             | 20                | 2                                      |                      | 1                   | 1              | 31    |
| VHF, Portable, Low-Power           |               | 3             |                   |  |                      |                     |                | 3     |
| VHF, Portable, Very-Low-Power      | 1             | 4             | 10                |  |                      |                     |                | 15    |
| VHF, Vehicle Mount, Medium-Power   | 1             | 15            | 1                 | 3                                      | 3                    |                     |                | 23    |
| HF, Manpack, Low-Power             |               |               | 1                 | 2                                      | 1                    |                     |                | 4     |
| HF, Vehicle Mount, Medium-Power    |               | 1             | 1                 |  |                      |                     |                | 2     |
| HF/VHF, Vehicle Mount, Med-Power   | 4             | 1             | 1                 |  |                      |                     |                | 6     |
| HF/VHF, Vehicle Mount, High-Power  | 2             | 1             | 1                 |  |                      |                     |                | 4     |
| Radio Relay, VHF/UHF               | 1             |               |                   |  |                      |                     |                | 1     |
| Warning Receiver                   | 2             | 3             | 4                 |  |                      |                     |                | 9     |
| <b>MISCELLANEOUS</b>               |               |               |                   |  |                      |                     |                |       |
| SA-8 Transloader (TELAR Chassis)   |               | 4             |                   |  |                      |                     |                | 4     |

FOOTNOTE: \* The TELAR includes the LAND ROLL fire control/target acquisition radar.

SAM Battalion (SA-8), Air Defense Regt

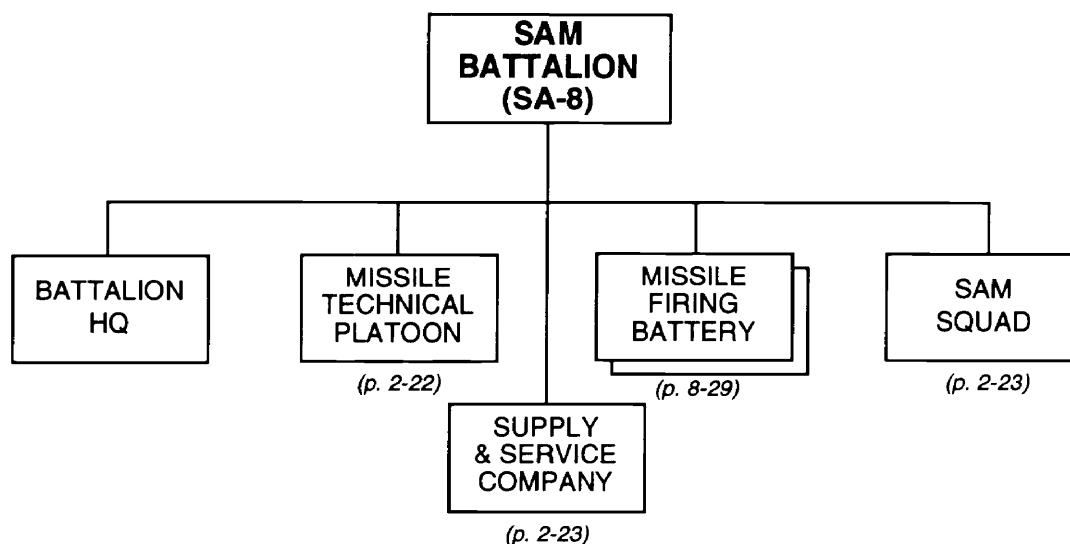

**PRINCIPAL ITEMS OF EQUIPMENT**

| <u>Equipment</u>                            | <u>Total</u> | <u>Equipment</u>                       | <u>Total</u> |
|---|--------------|--|--------------|
| SAM, SA-8/GECKO TELAR*                      | 8            | Trailer, Van                           | 4            |
| SAM, Shoulder-Fired                         | 12           | Trailer, Water (1,200-Liter)           | 2            |
| ACV, BTR-60 (PU-12)                         | 3            | Trailer, Kitchen                       | 4            |
| SA-8 Missile Transloader<br>(TELAR Chassis) | 4            | Radios:                                |              |
| Truck, Utility                              | 2            | VHF, Manpack, Low-Power                | 6            |
| Truck, Light                                | 7            | VHF, Portable, Low-Power               | 3            |
| Truck, Medium                               | 19           | VHF, Portable,<br>Very-Low-Power       | 4            |
| Truck, Crane                                | 1            | VHF, Vehicle Mount,<br>Medium-Power    | 15           |
| Truck, POL (5,000-Liter)                    | 2            | HF, Vehicle Mount,<br>Medium-Power     | 1            |
| Van, Medium                                 | 2            | HF/VHF, Vehicle Mount,<br>Medium-Power | 1            |
| Van, Signal                                 | 1            | HF/VHF, Vehicle Mount,<br>High-Power   | 1            |
| Van, Maintenance                            | 5            | Warning Receiver                       | 3            |
| Van, Missile Testing                        | 2            |  |              |
| Trailer, Cargo, 1-Axle                      | 1            |  |              |
| Trailer, Cargo, 2-Axle                      | 5            |  |              |
| Trailer, Generator                          | 6            |  |              |
| Trailer, POL (4,200-Liter)                  | 2            |  |              |

FOOTNOTE: \* The TELAR includes the LAND ROLL fire control/target acquisition radar.

Missile Technical Platoon, SAM Bn (SA-8) \_\_\_\_\_

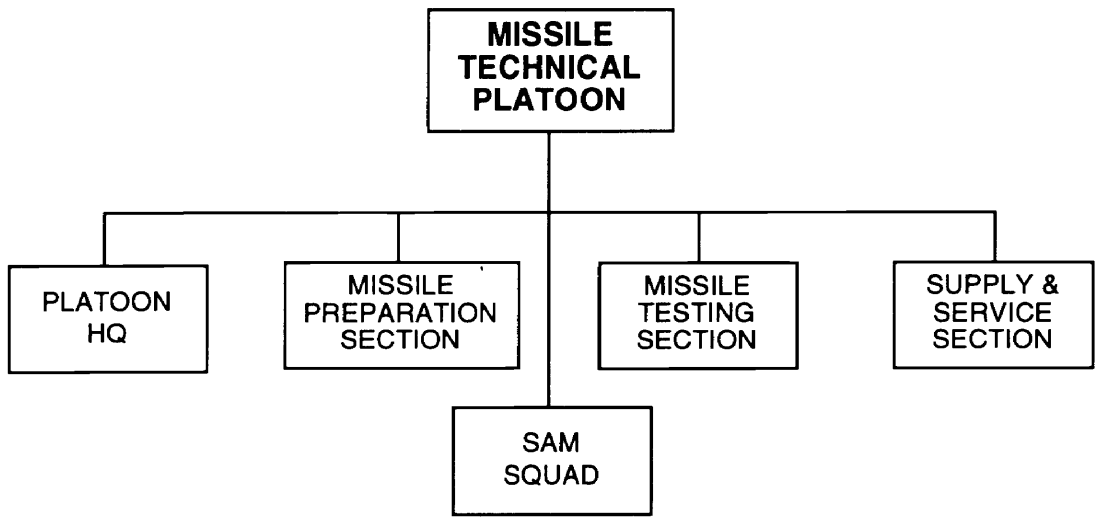

(p. 2-23)

**PRINCIPAL ITEMS OF EQUIPMENT**

| <u>Equipment</u>            | <u>Total</u> | <u>Equipment</u>                    | <u>Total</u> |
|-----------------------------|--------------|-------------------------------------|--------------|
| SAM, Shoulder-Fired.....    | 3            | Trailer, Generator.....             | 1            |
| Truck, Utility .....        | 1            | Trailer, Van.....                   | 1            |
| Truck, Light .....          | 3            | Trailer, Kitchen.....               | 1            |
| Truck, Medium .....         | 2            | Radios:                             |              |
| Truck, Crane .....          | 1            | VHF, Manpack, Low-Power.....        | 1            |
| Van, Missile Testing .....  | 2            | VHF, Portable, Low-Power .....      | 3            |
| Trailer, Cargo, 1-Axle..... | 1            | VHF, Portable, Very-Low-Power ..... | 1            |

**SAM Squad, SAM Bn (SA-2, SA-3, and SA-8) or AA Gun Bn (57-mm) or Missile Firing Btry (SA-6 and SA-8) or AA Gun Btry (57-mm) or AA Gun Bn (Mixed) or Missile Technical Pit, SAM Bn (SA-8) or Missile Technical Btry, SAM Regt (SA-6 and SA-8)** \_\_\_\_\_



**PRINCIPAL ITEMS OF EQUIPMENT**

| <u>Equipment</u>                  | <u>Total</u> | <u>Equipment</u>      | <u>Total</u> |
|-----------------------------------|--------------|-----------------------|--------------|
| SAM, Shoulder-Fired.....          | 3            | Radio, VHF, Portable, |              |
| 5.45-mm Assault Rifle, AK-74..... | 3            | Very-Low-Power .....  | 1            |
| Truck, Light .....                | 1            |                       |              |

**Supply and Service Company, SAM Bn (SA-8)** \_\_\_\_\_

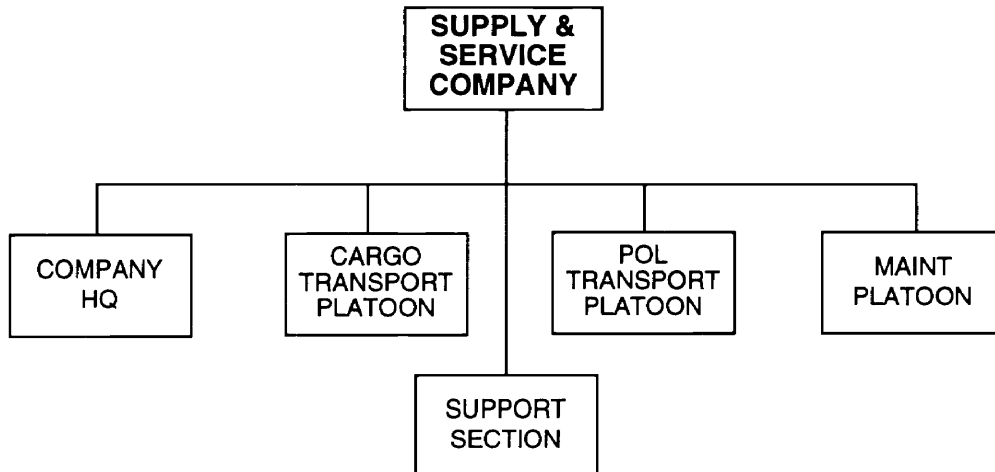

**PRINCIPAL ITEMS OF EQUIPMENT**

| <u>Equipment</u>              | <u>Total</u> | <u>Equipment</u>                     | <u>Total</u> |
|-------------------------------|--------------|--------------------------------------|--------------|
| Truck, Utility .....          | 1            | Trailer, Generator.....              | 4            |
| Truck, Light .....            | 1            | Trailer, Kitchen.....                | 1            |
| Truck, Medium .....           | 17           | Trailer, POL (4,200-Liter) .....     | 2            |
| Truck, POL (5,000-Liter)..... | 2            | Trailer, Van.....                    | 1            |
| Van, Maintenance .....        | 5            | Trailer, Water (900-Liter) .....     | 2            |
| Trailer, Cargo, 2-Axle.....   | 3            | Radio, VHF, Manpack, Low-Power ..... | 1            |



Antiaircraft Gun Battalion (57-mm),  
Air Defense Regt

---

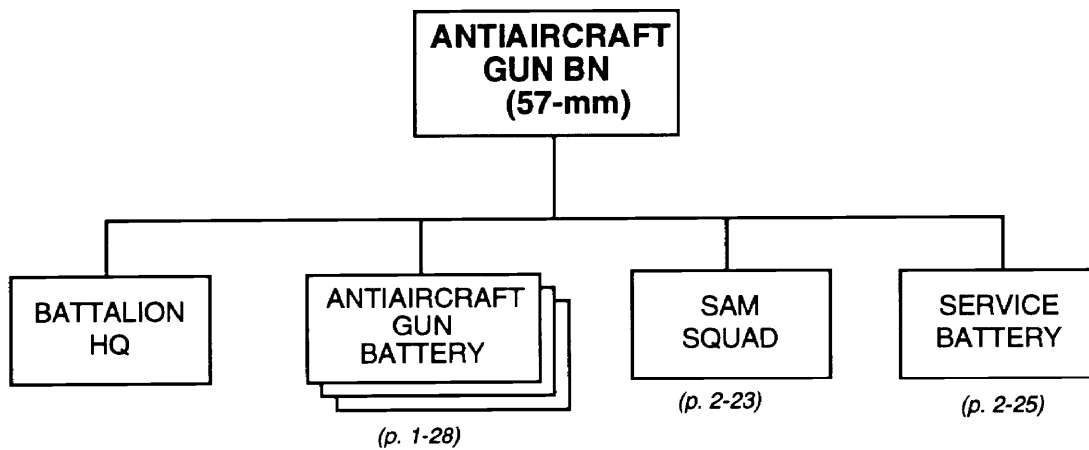

**PRINCIPAL ITEMS OF EQUIPMENT**

| <u>Equipment</u>                  | <u>Total</u> |
|-----------------------------------|--------------|
| 57-mm AA Gun, S-60.....           | 18           |
| SAM, Shoulder-Fired.....          | 12           |
| ACV, BTR-60 (PU-12).....          | 1            |
| Truck, Utility .....              | 7            |
| Truck, Light .....                | 7            |
| Truck, Medium .....               | 36           |
| Truck, Crane .....                | 1            |
| Truck, POL (5,000-Liter).....     | 4            |
| Truck, Water (2,000-Liter) .....  | 1            |
| Van, Maintenance .....            | 3            |
| Van, Radar .....                  | 4            |
| Van, Signal.....                  | 1            |
| Trailer, Cargo, 2-Axle.....       | 3            |
| Trailer, Generator.....           | 5            |
| Trailer, Kitchen .....            | 4            |
| Trailer, POL (1,200-Liter) .....  | 4            |
| Trailer, Water (900-Liter) .....  | 3            |
| Trailer, Water (1,200-Liter)..... | 2            |

| <u>Equipment</u>  | <u>Total</u> |
|---|--------------|
| <b>Radars:</b>  |              |
| Fire Control, FLAP WHEEL .....                            | 3            |
| Aerial Surveillance/Target<br>Acquisition, FLAT FACE..... | 1            |
| <b>Radios:</b>  |              |
| VHF, Portable, Very-Low-Power .....                       | 10           |
| VHF, Manpack, Low-Power.....                              | 20           |
| VHF, Vehicle Mount,<br>Medium-Power .....                 | 1            |
| HF/VHF, Vehicle Mount,<br>High-Power .....                | 1            |
| HF/VHF, Vehicle Mount,<br>Medium-Power .....              | 1            |
| HF, Manpack, Low-Power.....                               | 1            |
| HF, Vehicle Mount,<br>Medium-Power .....                  | 1            |
| Warning Receiver .....                                    | 4            |

Service Battery, AA Gun Bn (57-mm)

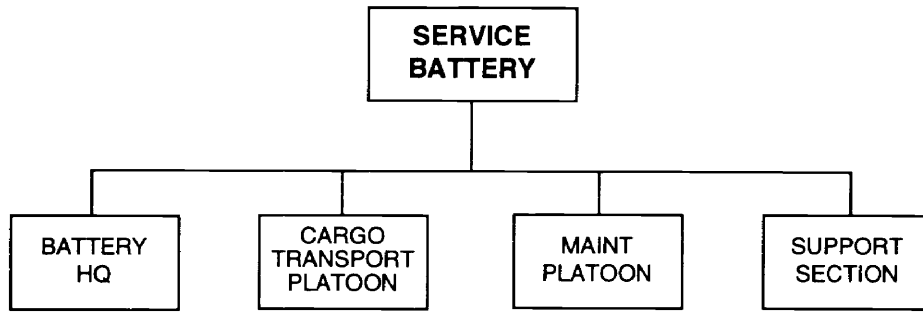

PRINCIPAL ITEMS OF EQUIPMENT

| <u>Equipment</u>                 | <u>Total</u> | <u>Equipment</u>                   | <u>Total</u> |
|----------------------------------|--------------|------------------------------------|--------------|
| Truck, Utility .....             | 4            | Trailer, Generator.....            | 1            |
| Truck, Light .....               | 3            | Trailer, Kitchen.....              | 1            |
| Truck, Medium .....              | 9            | Trailer, POL (1,200-Liter) .....   | 1            |
| Truck, Crane .....               | 1            | Trailer, Water (1,200-Liter) ..... | 1            |
| Truck, POL (5,000-Liter).....    | 1            | Radios:                            |              |
| Truck, Water (2,000-Liter) ..... | 1            | VHF, Manpack, Low-Power.....       | 2            |
| Van, Maintenance .....           | 3            | HF, Manpack, Low-Power.....        | 1            |
| Trailer, Cargo, 2-Axle.....      | 3            |                                    |              |

Materiel Support Company, Air Defense Regt

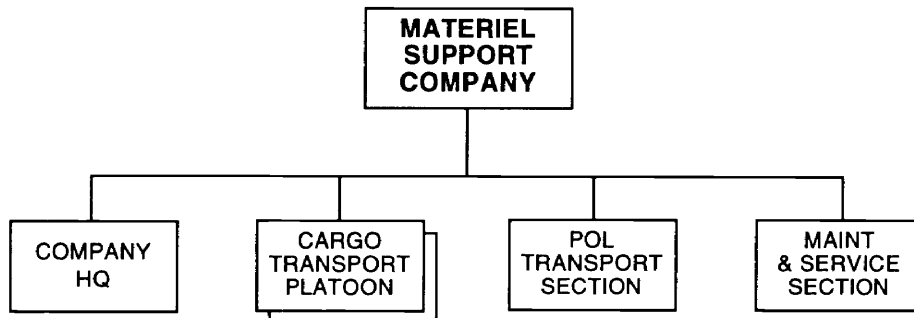

PRINCIPAL ITEMS OF EQUIPMENT

| <u>Equipment</u>                 | <u>Total</u> | <u>Equipment</u>                     | <u>Total</u> |
|----------------------------------|--------------|--------------------------------------|--------------|
| Truck, Utility .....             | 3            | Trailer, Cargo, 2-Axle.....          | 5            |
| Truck, Light .....               | 2            | Trailer, Generator.....              | 2            |
| Truck, Medium .....              | 25           | Trailer, Kitchen.....                | 3            |
| Truck, POL (5,000- Liter).....   | 3            | Trailer, POL (4,200-Liter) .....     | 3            |
| Truck, Water (2,000-Liter) ..... | 2            | Trailer, Water (1,200-Liter) .....   | 1            |
| Van, Maintenance .....           | 2            | Radio, VHF, Manpack, Low-Power ..... | 1            |

ATGM Battalion, Mech Inf Bde (Sep) or Mech Inf Div  
or MD or Army or CDF or National

---

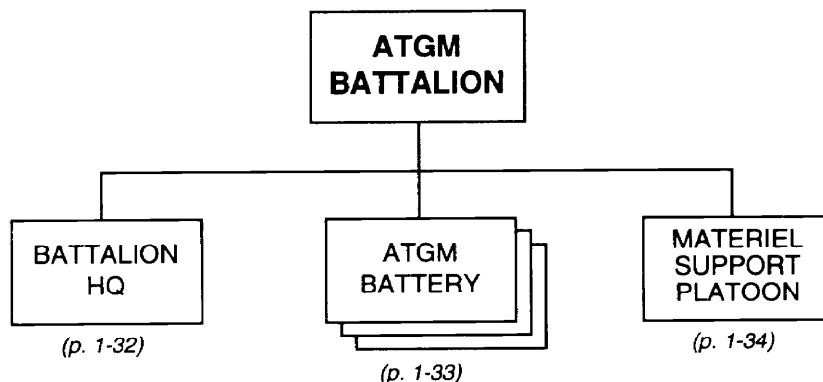

**PRINCIPAL ITEMS OF EQUIPMENT**

| <u>Equipment</u>  | <u>Total</u> | <u>Equipment</u>  | <u>Total</u> |
|---|--------------|---|--------------|
| ATGM Vehicle, 9P133,<br>w/AT-3/SAGGER or 9P148,<br>w/AT-5/SPANDREL..... | 27           | Trailer, POL (4,200-Liter) .....  | 3            |
| ATGL, RPG-7V.....   | 27           | Trailer, Water (900-Liter) .....  | 1            |
| ACV, BTR (R-145BM)/BRDM-2U .....  | 1            | Rangefinder, Stereoscopic, DS-1 .....   | 3            |
| ACV, BRDM-2U.....   | 12           | Radar, Battlefield Surveillance, Man-<br>Portable, PSNR-1, or TALL MIKE ..... | 4            |
| Truck, Utility .....  | 3            | Radios:   |              |
| Truck, Light .....  | 4            | VHF, Manpack, Low-Power.....  | 16           |
| Truck, Medium .....   | 16           | VHF, Vehicle Mount,<br>Medium-Power .....                                     | 40           |
| Truck, POL (5,000-Liter).....   | 3            | HF/VHF, Vehicle Mount,<br>Medium-Power .....                                  | 3            |
| Van, Maintenance .....  | 2            | HF, Vehicle Mount,<br>Medium-Power .....                                      | 1            |
| Van, Signal.....  | 2            | Radio Relay, VHF/UHF.....   | 1            |
| Ambulance .....   | 1            | Warning Receiver .....  | 1            |
| Trailer, Cargo, 2-Axle.....   | 8            |   |              |
| Trailer, Generator.....   | 1            |   |              |
| Trailer, Kitchen.....   | 1            |   |              |

**NOTES:**

1. Separate mechanized infantry brigades and well-equipped districts can have either the ATGM battalion as depicted above or an antitank battalion (see p. 4-26) composed of two antitank gun batteries and one ATGM battery.
2. During force modernization, the tendency is for districts/brigades with offensive contingency missions to have an ATGM battalion, whereas districts/brigades with primarily defensive contingency missions have the standard antitank battalion.

**Reconnaissance and Electronic Combat Battalion, Mech Inf Div  
or MD or Army or CDF or DMI**

---

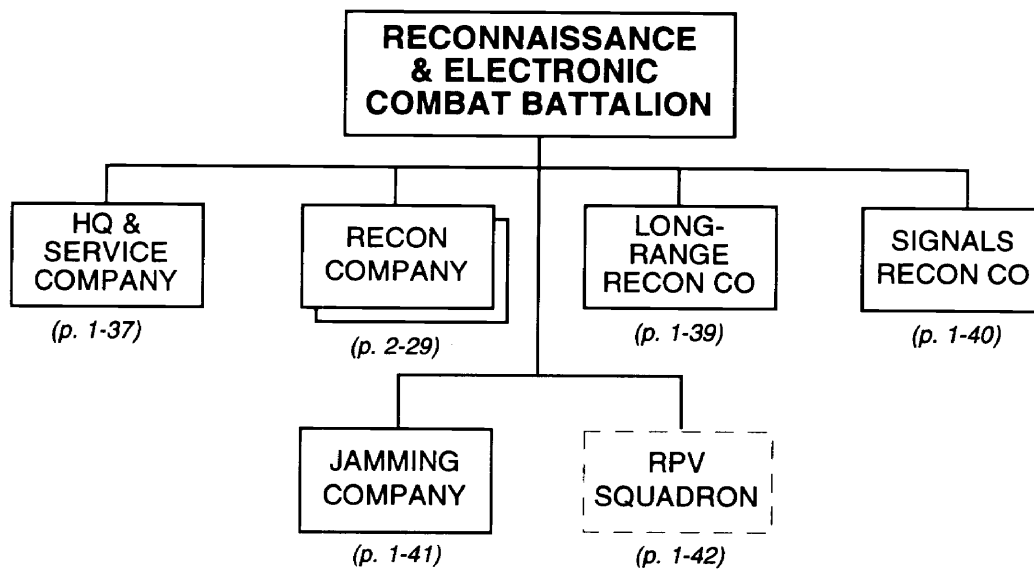

**NOTES:**

1. A reconnaissance and electronic combat (EC) battalion subordinate to the CDF or the DMI would normally have an organic RPV squadron. If the General Staff allocates a reconnaissance and EC battalion from the DMI to a military district or an expeditionary army, it normally includes an RPV squadron.
2. District and divisional reconnaissance and EC battalions may or may not have an organic RPV squadron. However, a mechanized infantry division is more likely to have one than are motorized infantry or infantry divisions.
3. The equipment listing for the reconnaissance and EC battalion includes the assets of the RPV squadron.

**(continued)**

Reconnaissance and Electronic Combat Battalion, Mech hf Div  
or MD or Army or CDF (continued)

| <i>Principal Items of Equipment</i> | <i>HQ &amp; Service Co</i> | <i>Recon Co (2x)</i> | <i>Long-Range Recon Co</i> | <i>Signals Recon Co</i> | <i>Jamming Co</i> | <i>RPV Sqdn</i> | <i>TOTAL</i> |
|-------------------------------------|----------------------------|----------------------|----------------------------|-------------------------|-------------------|-----------------|--------------|
| <b>ARMORED VEHICLES</b>             |                            |                      |                            |                         |                   |                 |              |
| ACV, BTR (R-145BM)                  | 2                          |                      |                            |                         |                   |                 | 2            |
| ACV, BRM-1K*                        | 1                          | 8                    |                            |                         |                   |                 | 9            |
| ACV, BRDM-2U                        |                            |                      | 1                          |                         |                   |                 | 1            |
| ASC, BRDM-2                         |                            |                      | 12                         |                         |                   |                 | 12           |
| IFV, BMP-1/2                        |                            | 12                   |                            |                         |                   |                 | 12           |
| <b>REMOTELY-PILOTED VEHICLES</b>    |                            |                      |                            |                         |                   |                 |              |
| RPV, Short-Range                    |                            |                      |                            |                         |                   | 4               | 4            |
| RPV Launch Vehicle (Truck, Medium)  |                            |                      |                            |                         |                   | 4               | 4            |
| RPV Recovery Vehicle (Truck, Crane) |                            |                      |                            |                         |                   | 2               | 2            |
| Van, Ground Control Station (RPV)   |                            |                      |                            |                         |                   | 2               | 2            |
| Van, Mission Control (RPV)          |                            |                      |                            |                         |                   | 1               | 1            |
| <b>ELECTRONIC COMBAT SYSTEMS</b>    |                            |                      |                            |                         |                   |                 |              |
| Radar Intercept/DF                  |                            |                      |                            | 3                       |                   |                 | 3            |
| Radio Intercept/DF, VHF/HF          |                            |                      |                            | 7                       | 3                 |                 | 10           |
| Communications Jammer, VHF          |                            |                      |                            |                         | 6                 |                 | 6            |
| Communications Jammer, HF           |                            |                      |                            |                         | 3                 |                 | 3            |
| Proximity Fuze Jammer               |                            |                      |                            |                         | 9                 |                 | 9            |
| <b>TRUCKS</b>                       |                            |                      |                            |                         |                   |                 |              |
| Truck, Utility                      | 4                          |                      |                            | 1                       |                   | 4               | 9            |
| Truck, Light                        | 5                          |                      |                            | 1                       | 2                 | 1               | 9            |
| Truck, Medium                       | 4                          |                      |                            |                         |                   | 1               | 5            |
| Truck, POL (5,000-L)                | 3                          |                      |                            |                         |                   |                 | 3            |
| Truck, Water (2,000-L)              | 1                          |                      |                            |                         |                   |                 | 1            |
| Van, Command                        | 2                          |                      |                            | 1                       | 1                 | 1               | 5            |
| Van, Jammer                         |                            |                      |                            |                         | 18                |                 | 18           |
| Van, Maintenance                    | 1                          |                      |                            | 1                       | 1                 | 1               | 4            |
| Van, Signal                         | 6                          |                      |                            |                         |                   |                 | 6            |
| Van, Signals Reconnaissance         |                            |                      |                            | 10                      | 3                 |                 | 13           |
| Ambulance                           | 1                          |                      |                            |                         |                   |                 | 1            |
| <b>TRAILERS</b>                     |                            |                      |                            |                         |                   |                 |              |
| Trailer, Generator                  | 1                          |                      |                            | 11                      | 21                | 3               | 36           |
| Trailer, Kitchen                    | 6                          |                      |                            | 1                       | 1                 | 1               | 9            |
| Trailer, POL (4,200-L)              | 3                          |                      |                            |                         |                   |                 | 3            |
| Trailer, Water (900-L)              | 2                          |                      |                            | 1                       | 1                 | 1               | 5            |
| <b>RADIOS</b>                       |                            |                      |                            |                         |                   |                 |              |
| VHF, Manpack, Low-Power             | 2                          | 20                   | 13                         | 7                       |                   | 13              | 55           |
| VHF, Vehicle Mount, Medium-Power    | 3                          | 20                   | 13                         |                         | 22                | 4               | 62           |
| HF, Manpack, Low-Power              | 2                          | 2                    | 1                          | 4                       |                   |                 | 9            |
| HF, Vehicle Mount, Medium-Power     | 1                          | 2                    | 1                          |                         | 1                 | 1               | 6            |
| HF/VHF, Vehicle Mount, Med-Power    | 2                          |                      |                            | 4                       |                   |                 | 6            |
| HF/VHF, Vehicle Mount, High-Power   | 1                          |                      |                            | 1                       |                   |                 | 2            |
| Radio Relay, VHF/UHF                | 1                          |                      |                            |                         |                   |                 | 1            |
| Radio Telegraph                     | 6                          |                      |                            |                         |                   |                 | 6            |
| Warning Receiver                    | 2                          | 2                    | 1                          | 1                       | 1                 | 1               | 8            |

**FOOTNOTE:**

\*This system includes the TALL MIKE battlefield surveillance radar.

Reconnaissance Company, Recon & EC Bn, Mech Inf Div  
 or MD or Army or CDF or DMI \_\_\_\_\_

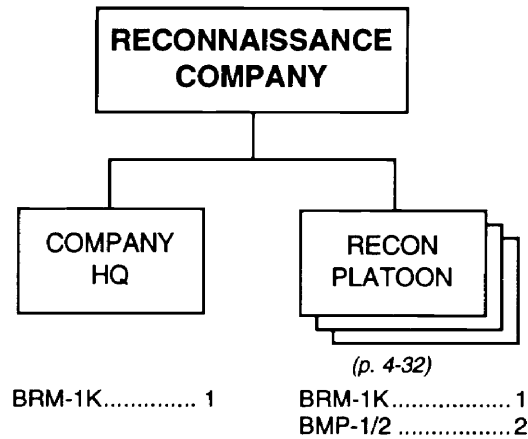

**PRINCIPAL ITEMS OF EQUIPMENT**

| <u>Equipment</u>                                   | <u>Total</u> |
|--|--------------|
| ACV, BRM-1K* .....                                 | 4            |
| IFV, BMP-1/2 .....                                 | 6            |
| 9-mm Pistol, PM.....                               | 31           |
| 5.45-mm Assault Rifle, AK-74.....                  | 40           |
| 5.45-mm LMG, RPK-74.....                           | 10           |
| 40-mm Under-Barrel Grenade Launcher,<br>BG-15..... | 10           |
| ATRL, RPG-18/22.....                               | 10           |
| ATGL, RPG-7V .....                                 | 10           |
| Night-Vision Goggles .....                         | 10           |

| <u>Equipment</u>                          | <u>Total</u> |
|---|--------------|
| Night-Vision Sight (Small Arms).....      | 10           |
| Radios:                                   |              |
| VHF, Manpack, Low-Power.....              | 10           |
| VHF, Vehicle Mount,<br>Medium-Power ..... | 10           |
| HF, Manpack, Low-Power.....               | 1            |
| HF, Vehicle Mount,<br>Medium-Power .....  | 1            |
| Warning Receiver .....                    | 1            |

**NOTE:** The mix of BRM-1K and BMP vehicles can vary.

**FOOTNOTE:** \* This vehicle includes the TALL MIKE battlefield surveillance radar.

**Engineer Battalion, Mech Inf Div, Mech Inf Div, and Inf Div, or MD or Army or CDF or National (Engr Bde)**

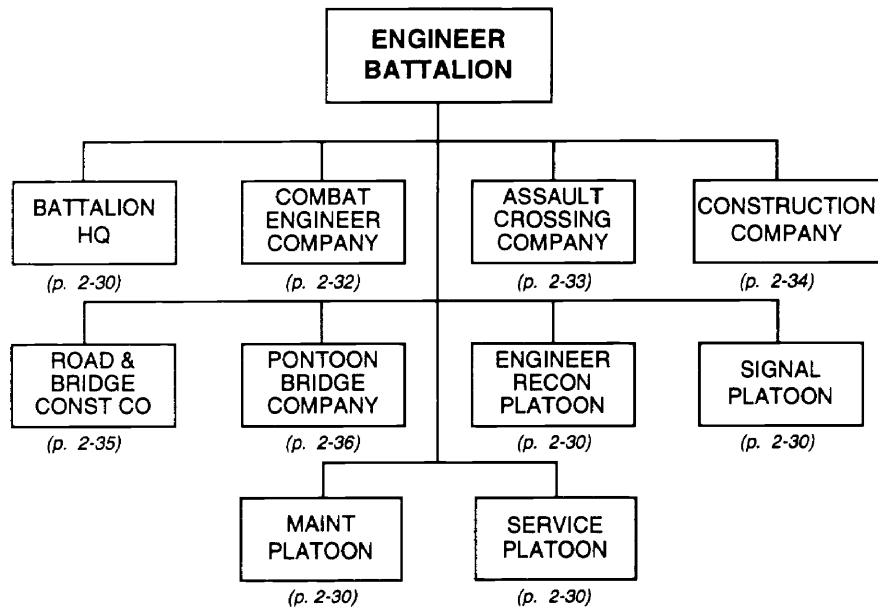

| <i>Principal Items of Equipment</i> | <i>Battalion HQ</i> | <i>Combat Engr Co</i> | <i>Assault Crossing Co</i> | <i>Construction Co</i> | <i>Road &amp; Bridge Const Co</i> | <i>Ponton Bridge Co</i> | <i>Engr Recon Plt</i> | <i>Signal Plt</i> | <i>Maintenance Plt</i> | <i>Service Plt</i> | <i>TOTAL</i> |
|-------------------------------------|---------------------|-----------------------|----------------------------|------------------------|-----------------------------------|-------------------------|-----------------------|-------------------|------------------------|--------------------|--------------|
| <b>ARMORED VEHICLES</b>             |                     |                       |                            |                        |                                   |                         |                       |                   |                        |                    |              |
| APC, BTR-60/70/80                   |                     |                       |                            |                        |                                   |                         | 3                     |                   |                        |                    | 3            |
| ACV, BTR (R-145BM)                  |                     | 1                     |                            |                        |                                   |                         |                       |                   |                        |                    | 1            |
| ACV, BRDM-2U                        |                     |                       | 1                          |                        |                                   |                         |                       |                   |                        |                    | 1            |
| Armored Recovery Vehicle            |                     |                       |                            |                        |                                   |                         |                       |                   | 3                      |                    | 3            |
| <b>WEAPONS</b>                      |                     |                       |                            |                        |                                   |                         |                       |                   |                        |                    |              |
| ATGL, RPG-7V                        |                     |                       |                            |                        |                                   |                         | 6                     |                   |                        |                    | 6            |
| ATRL, RPG-18/22                     |                     | 3                     |                            |                        |                                   |                         |                       |                   |                        |                    | 3            |
| SAM, Shoulder-Fired                 |                     |                       | 3                          |                        | 3                                 | 3                       |                       |                   |                        |                    | 9            |
| <b>ENGINEER EQUIPMENT</b>           |                     |                       |                            |                        |                                   |                         |                       |                   |                        |                    |              |
| Minelayer, PMR/GMZ*                 |                     | 3                     |                            |                        |                                   |                         |                       |                   |                        |                    | 3            |
| Mineclearer, MTK/MTK-2              |                     | 2                     |                            |                        |                                   |                         |                       |                   |                        |                    | 2            |
| Mine Detector, DIM                  |                     | 2                     |                            |                        |                                   |                         | 1                     |                   |                        |                    | 3            |
| Engineer Recon Vehicle, IRM         |                     |                       |                            |                        |                                   |                         | 2                     |                   |                        |                    | 2            |
| Armored Engineer Tractor, IMR       |                     | 2                     |                            |                        |                                   |                         |                       |                   |                        |                    | 2            |
| Ditching Machine, PZM/BTM/MDK       |                     |                       |                            | 4                      |                                   |                         |                       |                   |                        |                    | 4            |
| Route-Clearing Vehicle, BAT/PKT     |                     |                       |                            | 6                      | 2                                 |                         |                       |                   |                        |                    | 8            |
| Bridge, Tank-Launched               |                     |                       |                            |                        | 4                                 |                         |                       |                   |                        |                    | 4            |
| Bridge, Truck-Launched              |                     |                       |                            |                        | 8                                 |                         |                       |                   |                        |                    | 8            |
| Tracked Amphibian, K-61/PTS         |                     |                       | 12                         |                        |                                   |                         |                       |                   |                        |                    | 12           |
| Trailer, Amphibious, PKP            |                     |                       | 6                          |                        |                                   |                         |                       |                   |                        |                    | 6            |

**FOOTNOTE:**

\* When the armored tracked minelayer GMZ replaces the towed PMR, the combat engineer company needs only five medium, trucks, but has a total of eight VHF, vehicle mount, medium-power radios.

**(continued)**

Engineer Battalion, Mech Inf Div, Mtzd Inf Div, and Inf Div, or MD or Army or CDF  
or National (Engr Bde) (continued)

| <i>Principal Items of Equipment</i>   | <i>Battalion HQ</i> | <i>Combat Engr Co</i> | <i>Assault Crossing Co</i> | <i>Construction Co</i> | <i>Road &amp; Bridge Const Co</i> | <i>Pontoon Bridge Co</i> | <i>Engr Recon Plt</i> | <i>Signal Plt</i> | <i>Maintenance Plt</i> | <i>Service Plt</i> | <i>TOTAL</i> |
|---------------------------------------|---------------------|-----------------------|----------------------------|------------------------|-----------------------------------|--------------------------|-----------------------|-------------------|------------------------|--------------------|--------------|
| <b>ENGINEER EQUIPMENT (continued)</b> |                     |                       |                            |                        |                                   |                          |                       |                   |                        |                    |              |
| Tracked Ferry, GSP/PMM-2**            |                     |                       | 6                          |                        |                                   |                          |                       |                   |                        |                    | 6            |
| Bridge, PMP Center                    |                     |                       |                            |                        |                                   | 16                       |                       |                   |                        |                    | 16           |
| Bridge, PMP Ramp                      |                     |                       |                            |                        |                                   | 2                        |                       |                   |                        |                    | 2            |
| Assault Boat                          |                     |                       | 10                         |                        |                                   |                          |                       |                   |                        |                    | 10           |
| Power Boat                            |                     |                       |                            |                        |                                   | 6                        |                       |                   |                        |                    | 6            |
| Piledriver Set, KMS                   |                     |                       |                            | 1                      |                                   |                          |                       |                   |                        |                    | 1            |
| Tractor                               |                     |                       |                            | 2                      |                                   |                          |                       |                   |                        |                    | 2            |
| Truck, Sawmill                        |                     |                       |                            |                        | 1                                 |                          |                       |                   |                        |                    | 1            |
| Trailer, Saw                          |                     |                       |                            |                        | 1                                 |                          |                       |                   |                        |                    | 1            |
| Grader                                |                     |                       |                            |                        | 2                                 |                          |                       |                   |                        |                    | 2            |
| Concrete Mixer                        |                     |                       |                            |                        | 1                                 |                          |                       |                   |                        |                    | 1            |
| Truck, Water Purification             |                     |                       |                            | 1                      |                                   |                          |                       |                   |                        |                    | 1            |
| <b>TRUCKS</b>                         |                     |                       |                            |                        |                                   |                          |                       |                   |                        |                    |              |
| Truck, Utility                        | 2                   |                       |                            | 1                      | 1                                 | 1                        | 2                     | 1                 |                        | 1                  | 9            |
| Truck, Medium*                        | 1                   | 8                     | 2                          | 13                     | 2                                 |                          | 1                     | 1                 | 1                      | 1                  | 30           |
| Truck, Dump                           |                     |                       |                            | 1                      | 2                                 |                          |                       |                   |                        |                    | 3            |
| Truck, Crane                          |                     |                       | 1                          |                        |                                   |                          |                       |                   |                        |                    | 1            |
| Truck, Crane Shovel                   |                     |                       |                            | 2                      | 2                                 |                          |                       |                   |                        |                    | 4            |
| Truck, POL (5,000-L)                  |                     |                       |                            |                        |                                   |                          |                       |                   |                        | 9                  | 9            |
| Truck, Water (2,000-L)                |                     |                       |                            |                        |                                   |                          |                       |                   |                        | 1                  | 1            |
| Van, Kitchen                          |                     |                       |                            |                        |                                   |                          |                       |                   |                        | 1                  | 1            |
| Van, Medium                           |                     |                       |                            |                        |                                   |                          |                       |                   |                        | 1                  | 1            |
| Van, Maintenance                      |                     |                       |                            |                        |                                   |                          |                       | 4                 |                        |                    | 4            |
| Van, Signal                           |                     |                       |                            |                        |                                   |                          | 1                     |                   |                        |                    | 1            |
| Ambulance                             |                     |                       |                            |                        |                                   |                          |                       |                   |                        | 1                  | 1            |
| <b>TRAILERS</b>                       |                     |                       |                            |                        |                                   |                          |                       |                   |                        |                    |              |
| Trailer, Cargo, 1-Axle                | 1                   | 2                     |                            |                        | 1                                 |                          |                       |                   |                        |                    | 4            |
| Trailer, Cargo, 2-Axle                |                     |                       | 1                          | 1                      |                                   |                          |                       |                   | 1                      |                    | 3            |
| Trailer, Compressor                   |                     |                       | 1                          |                        |                                   |                          |                       |                   |                        |                    | 1            |
| Trailer, Generator                    |                     |                       |                            | 1                      | 1                                 |                          |                       | 1                 | 1                      | 1                  | 5            |
| Trailer, Kitchen                      |                     | 1                     | 1                          | 1                      | 1                                 | 1                        |                       |                   |                        | 1                  | 6            |
| Trailer, POL (4,200-L)                |                     |                       |                            |                        |                                   |                          |                       |                   |                        | 9                  | 9            |
| Trailer, Saw                          |                     |                       |                            |                        | 1                                 |                          |                       |                   |                        |                    | 1            |
| Trailer, Water (900-L)                |                     | 1                     | 1                          | 1                      | 1                                 | 1                        |                       |                   |                        |                    | 5            |
| <b>RADIOS</b>                         |                     |                       |                            |                        |                                   |                          |                       |                   |                        |                    |              |
| VHF, Manpack, Low-Power               |                     |                       |                            |                        |                                   |                          |                       |                   | 3                      | 1                  | 4            |
| VHF, Vehicle Mount, Medium-Power*     |                     | 5                     | 3                          | 3                      | 6                                 | 4                        | 3                     |                   | 3                      |                    | 27           |
| HF, Manpack, Low-Power                | 1                   | 1                     | 1                          | 1                      | 1                                 | 1                        | 3                     |                   |                        |                    | 9            |
| HF/VHF, Vehicle, Medium-Power         | 1                   |                       |                            |                        |                                   |                          |                       | 1                 |                        |                    | 2            |
| HF/VHF, Vehicle, High-Power           |                     |                       |                            |                        |                                   |                          |                       | 1                 |                        |                    | 1            |
| Warning Receiver                      | 1                   |                       |                            |                        |                                   |                          |                       |                   |                        |                    | 1            |

**FOOTNOTES:**

\* When the armored tracked minelayer GMZ replaces the towed PMR, the combat engineer company needs only five medium, trucks, but has a total of eight VHF, vehicle mount, medium-power radios.

\*\* With the GSP, 12 half-ferries form 6 ferries; with the PMM-2, there is only one vehicle per ferry.



Combat Engineer Company, Engr Bn or MR \_\_\_\_\_

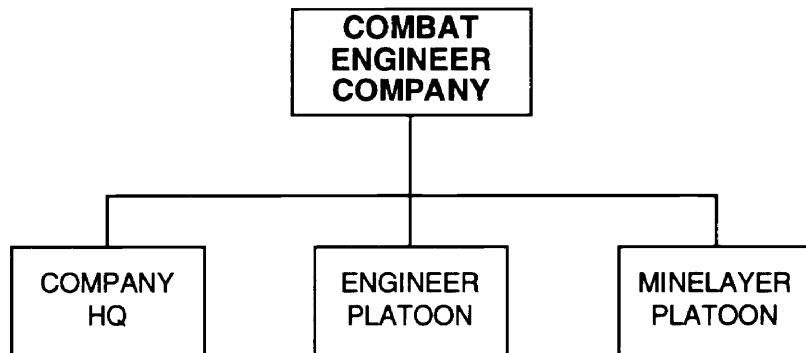

**PRINCIPAL ITEMS OF EQUIPMENT**

| <u>Equipment</u>                    | <u>Total</u> | <u>Equipment</u>                 | <u>Total</u> |
|-------------------------------------|--------------|----------------------------------|--------------|
| ACV, BTR (R-145BM) .....            | 1            | Trailer, Cargo, 1-Axle.....      | 2            |
| ATRL, RPG-18/22.....                | 3            | Trailer, Kitchen.....            | 1            |
| Armored Engineer Tractor, IMR ..... | 2            | Trailer, Water (900-Liter) ..... | 1            |
| Mineclearer, MTK/MTK-2.....         | 2            | Radios:                          |              |
| Mine Detector, DIM.....             | 2            | VHF, Vehicle Mount,              |              |
| Minelayer, PMR/GMZ* .....           | 3            | Medium-Power* .....              | 5            |
| Truck, Medium* .....                | 8            | HF, Manpack, Low-Power.....      | 1            |

**FOOTNOTE:** \* The armored tracked minelayer GMZ is more common in mechanized infantry divisions. When the GMZ replaces the towed PMR, this company needs only five medium trucks but has a total of eight vehicle-mounted radios.

Assault Crossing Company, Engr Bn

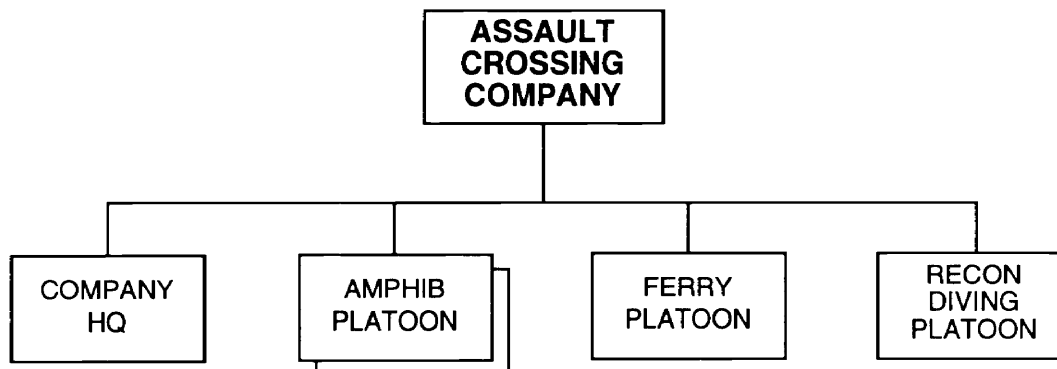

**PRINCIPAL ITEMS OF EQUIPMENT**

| <u>Equipment</u>                  | <u>Total</u> | <u>Equipment</u>                 | <u>Total</u> |
|-----------------------------------|--------------|----------------------------------|--------------|
| ACV, BRDM-2U .....                | 1            | Trailer, Cargo, 2-Axle.....      | 1            |
| SAM, Shoulder-Fired.....          | 3            | Trailer, Compressor .....        | 1            |
| Truck, Medium .....               | 2            | Trailer, Kitchen.....            | 1            |
| Truck, Crane .....                | 1            | Trailer, Water (900-Liter) ..... | 1            |
| Tracked Amphibian, K-61/PTS ..... | 12           | Radios:                          |              |
| Tracked Ferry, GSP/PMM-2* .....   | 6            | VHF, Vehicle Mount,              |              |
| Assault Boat.....                 | 10           | Medium-Power .....               | 3            |
| Trailer, Amphibious, PKP .....    | 6            | HF, Manpack, Low-Power.....      | 1            |

*FOOTNOTE:* \* Two GSP heavy amphibious ferry vehicles make up one ferry. Thus, the assault crossing company actually has 12 half-ferries. With the newer PMM-2 system, 6 PMM-2 vehicles can form 6 ferries.

Construction Company, Engr Bn \_\_\_\_\_

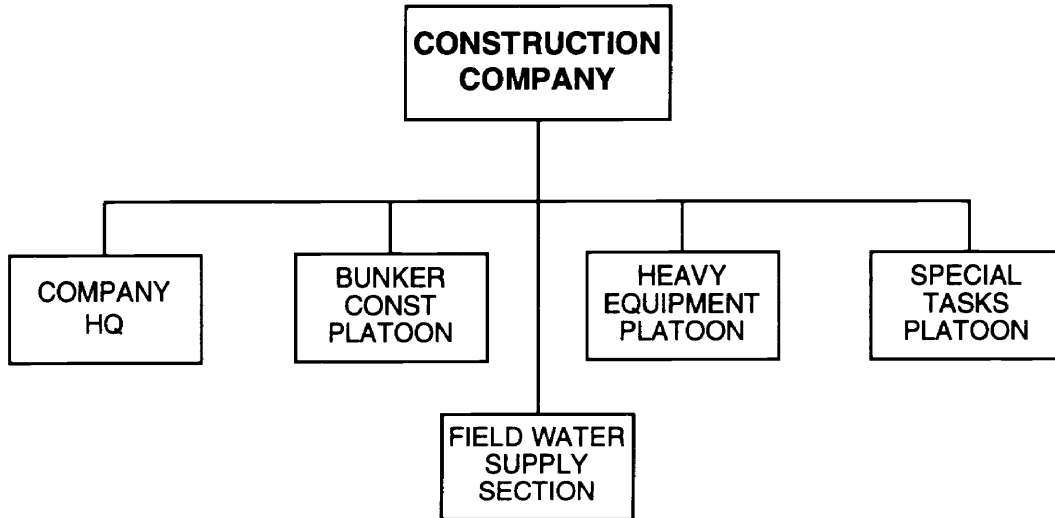

**PRINCIPAL ITEMS OF EQUIPMENT**

| <u>Equipment</u>                      | <u>Total</u> |
|---------------------------------------|--------------|
| Truck, Utility .....                  | 1            |
| Truck, Medium .....                   | 13           |
| Truck, Crane Shovel .....             | 2            |
| Truck, Dump .....                     | 1            |
| Truck, Water Purification .....       | 1            |
| Ditching Machine, PZM/BTM/MDK .....   | 4            |
| Route-Clearing Vehicle, BAT/PKT ..... | 6            |
| Piledriver Set, KMS .....             | 1            |
| Tractor .....                         | 2            |

| <u>Equipment</u>                 | <u>Total</u> |
|----------------------------------|--------------|
| Trailer, Cargo, 2-Axle .....     | 1            |
| Trailer, Generator .....         | 1            |
| Trailer, Kitchen .....           | 1            |
| Trailer, Water (900-Liter) ..... | 1            |
| Radios:                          |              |
| VHF, Vehicle Mount,              |              |
| Medium-Power .....               | 3            |
| HF, Manpack, Low-Power .....     | 1            |

Road and Bridge Construction Company,  
Engr Bn

---

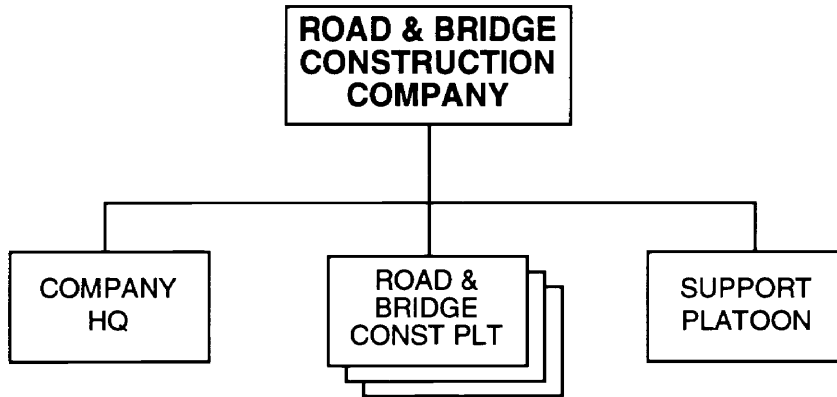

**PRINCIPAL ITEMS OF EQUIPMENT**

| <u>Equipment</u>                      | <u>Total</u> | <u>Equipment</u>                 | <u>Total</u> |
|---------------------------------------|--------------|----------------------------------|--------------|
| SAM, Shoulder-Fired.....              | 3            | Concrete Mixer .....             | 1            |
| Truck, Utility .....                  | 1            | Trailer, Cargo, 1-Axle.....      | 1            |
| Truck, Medium .....                   | 2            | Trailer, Generator.....          | 1            |
| Truck, Crane Shovel .....             | 1            | Trailer, Kitchen.....            | 1            |
| Truck, Dump.....                      | 2            | Trailer, Saw.....                | 1            |
| Truck, Sawmill .....                  | 1            | Trailer, Water (900-Liter) ..... | 1            |
| Bridge, Tank-Launched .....           | 4            | Radios:                          |              |
| Bridge, Truck-Launched .....          | 8            | VHF, Vehicle Mount,              |              |
| Route-Clearing Vehicle, BAT/PKT ..... | 2            | Medium-Power .....               | 6            |
| Grader .....                          | 2            | HF, Manpack, Low-Power.....      | 1            |

Pontoon Bridge Company, Engr Bn  
 or Pontoon Bridge Bn \_\_\_\_\_

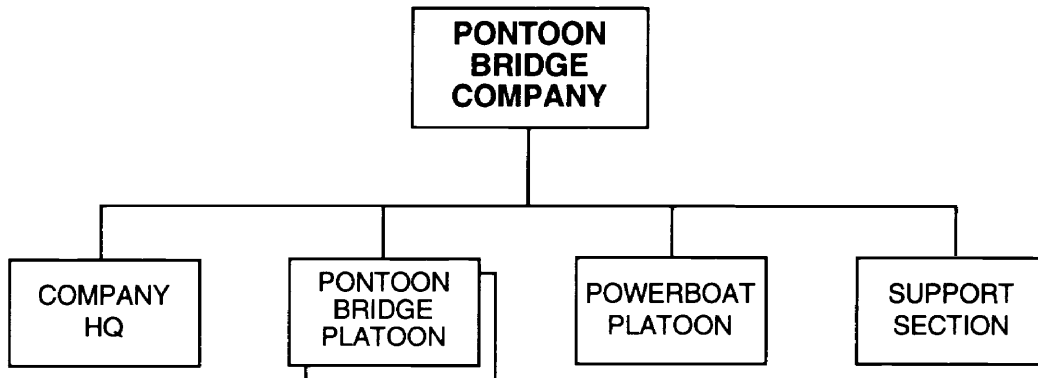

**PRINCIPAL ITEMS OF EQUIPMENT**

| <u>Equipment</u>         | <u>Total</u> | <u>Equipment</u>                 | <u>Total</u> |
|--------------------------|--------------|----------------------------------|--------------|
| SAM, Shoulder-Fired..... | 3            | Trailer, Water (900-Liter) ..... | 1            |
| Truck, Utility .....     | 1            | Radios:                          |              |
| Bridge, PMP Center ..... | 16           | VHF, Vehicle Mount,              |              |
| Bridge, PMP Ramp .....   | 2            | Medium-Power .....               | 4            |
| Powerboat .....          | 6            | HF, Manpack, Low-Power.....      | 1            |
| Trailer, Kitchen.....    | 1            |                                  |              |

*NOTE:* A full bridge set consists of 32 center and 4 ramp sections. The half-set held by the engineer battalion can make up a bridge (119 meters of 60-ton bridge, 191 meters of 20-ton bridge) or several rafts.

Signal Battalion, Mech Inf Div, Mtzd Inf Div, and Inf Div, or MD or Army  
 or CDF or National (Signal Bale) \_\_\_\_\_

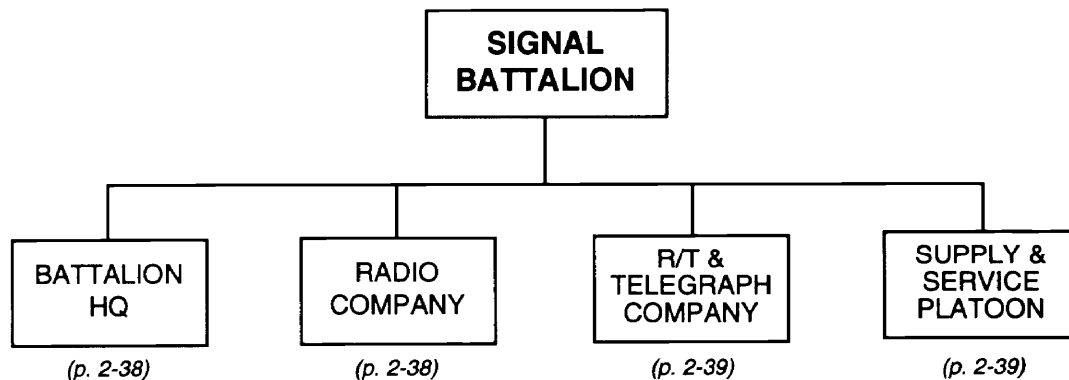

**PRINCIPAL ITEMS OF EQUIPMENT**

| <u>Equipment</u>                 | <u>Total</u> | <u>Equipment</u>              | <u>Total</u> |
|----------------------------------|--------------|-------------------------------|--------------|
| ACV, BTR (R-145BM) .....         | 8            | Radios:                       |              |
| Truck, Utility .....             | 12           | VHF, Manpack, Low-Power ..... | 20           |
| Truck, Light .....               | 7            | VHF, Vehicle Mount,           |              |
| Truck, Medium .....              | 9            | Medium-Power .....            | 6            |
| Truck, POL (5,000-Liter) .....   | 3            | HF/VHF, Vehicle Mount,        |              |
| Van, Maintenance .....           | 4            | High-Power .....              | 8            |
| Van, Signal .....                | 33           | HF/VHF, Vehicle Mount,        |              |
| Ambulance .....                  | 1            | Medium-Power .....            | 7            |
| Motorcycle .....                 | 13           | HF, Manpack, Low-Power .....  | 5            |
| Trailer, Cargo, 2-Axle .....     | 10           | HF, Vehicle Mount,            |              |
| Trailer, Generator .....         | 10           | Medium-Power .....            | 8            |
| Trailer, Kitchen .....           | 2            | Radio Relay, VHF/UHF .....    | 6            |
| Trailer, POL (4,200-Liter) ..... | 3            | Communication Center .....    | 2            |
| Trailer, Water (900-Liter) ..... | 1            | Warning Receiver .....        | 3            |

**NOTE:** The radios listed support the headquarters of the unit to which the signal battalion is organic or attached.

**Battalion Headquarters, Signa Bn** \_\_\_\_\_



**PRINCIPAL ITEMS OF EQUIPMENT**

| <u>Equipment</u>     | <u>Total</u> | <u>Equipment</u>                    | <u>Total</u> |
|----------------------|--------------|-------------------------------------|--------------|
| Truck, Utility ..... | 4            | Radio, HF, Manpack, Low-Power ..... | 1            |

**Radio Company, Signal Bn** \_\_\_\_\_

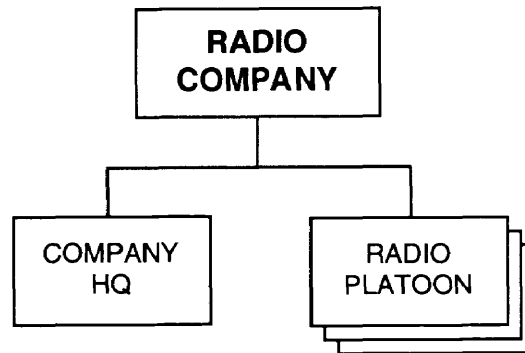

**PRINCIPAL ITEMS OF EQUIPMENT**

| <u>Equipment</u>             | <u>Total</u> | <u>Equipment</u>                             | <u>Total</u> |
|------------------------------|--------------|--|--------------|
| ACV, BTR (R-145BM) .....     | 8            | Radios:                                      |              |
| Truck, Utility .....         | 4            | VHF, Manpack, Low-Power .....                | 7            |
| Truck, Medium .....          | 1            | VHF, Vehicle Mount,<br>Medium-Power .....    | 6            |
| Van, Signal .....            | 12           | HF/VHF, Vehicle Mount,<br>High-Power .....   | 8            |
| Trailer, Cargo, 2-Axle ..... | 1            | HF/VHF, Vehicle Mount,<br>Medium-Power ..... | 6            |
| Trailer, Generator .....     | 3            | HF, Manpack, Low-Power .....                 | 1            |
|                              |              | HF, Vehicle Mount,<br>Medium-Power .....     | 8            |
|                              |              | Warning Receiver .....                       | 1            |

**Radio Telephone and Telegraph Company,  
Signal Bn**

---

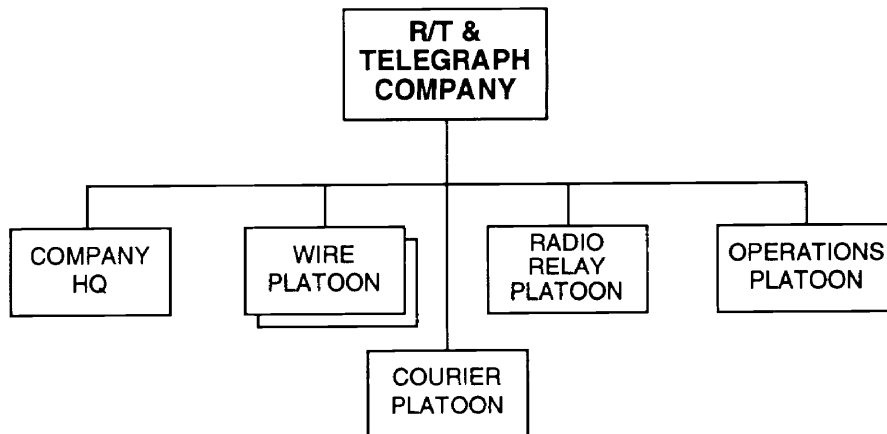

**PRINCIPAL ITEMS OF EQUIPMENT**

| <u>Equipment</u>            | <u>Total</u> | <u>Equipment</u>               | <u>Total</u> |
|-----------------------------|--------------|--------------------------------|--------------|
| Truck, Utility .....        | 3            | Radios:                        |              |
| Truck, Medium .....         | 2            | VHF, Manpack, Low-Power .....  | 13           |
| Van, Light .....            | 4            | HF/VHF, Vehicle Mount, Medium- |              |
| Van, Signal.....            | 21           | Power .....                    | 1            |
| Motorcycle .....            | 13           | HF, Manpack, Low-Power.....    | 2            |
| Trailer, Cargo, 1-Axle..... | 4            | Radio Relay, VHF/UHF.....      | 6            |
| Trailer, Generator.....     | 5            | Communications Center .....    | 2            |
|                             |              | Warning Receiver .....         | 2            |

*NOTE:* Motorcycles provide the division commander with messenger/courier service.

**Supply and Service Platoon,  
Signal Bn**

---



**PRINCIPAL ITEMS OF EQUIPMENT**

| <u>Equipment</u>              | <u>Total</u> | <u>Equipment</u>                    | <u>Total</u> |
|-------------------------------|--------------|-------------------------------------|--------------|
| Truck, Utility .....          | 1            | Trailer, Cargo, 2-Axle.....         | 5            |
| Truck, Medium .....           | 6            | Trailer, Generator.....             | 2            |
| Truck, POL (5,000-Liter)..... | 3            | Trailer, Kitchen.....               | 2            |
| Van, Light .....              | 3            | Trailer, POL (4,200-Liter) .....    | 3            |
| Van, Maintenance .....        | 4            | Trailer, Water (900-Liter) .....    | 1            |
| Ambulance .....               | 1            | Radio, HF, Manpack, Low-Power ..... | 2            |



Chemical Defense Company, Mech Inf Div  
 or MD or Army or CDF

---

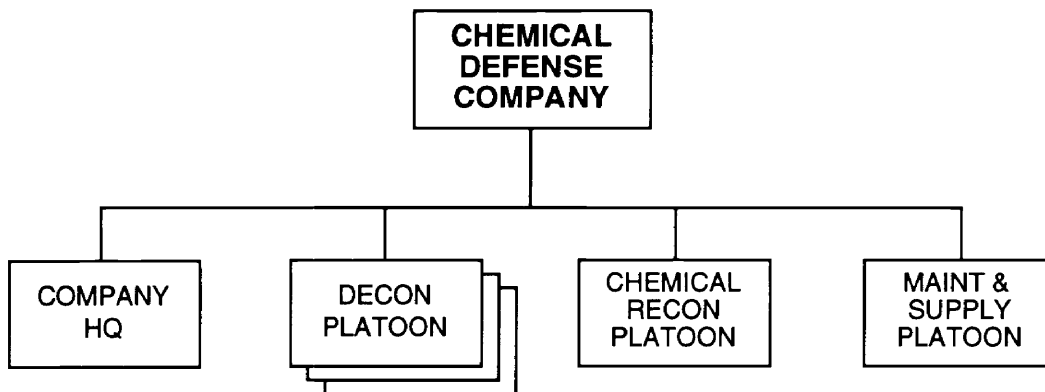

**PRINCIPAL ITEMS OF EQUIPMENT**

| <u>Equipment</u>                                | <u>Total</u> | <u>Equipment</u>                   | <u>Total</u> |
|---|--------------|------------------------------------|--------------|
| Chemical Recon Vehicle,<br>BRDM-2RKh/RKhM ..... | 4            | Truck, Water (2,000-Liter) .....   | 2            |
| Truck, Decon, ARS-12U/14 .....                  | 8            | Trailer, POL (4,200-Liter) .....   | 2            |
| Truck, Decon, DDA-53/66 .....                   | 4            | Trailer, Water (1,200-Liter) ..... | 2            |
| Truck, Decon, TMS-65 .....                      | 2            | Trailer, Water (900-Liter) .....   | 2            |
| Truck, Utility .....                            | 2            | Radios:                            |              |
| Truck, Light .....                              | 3            | VHF, Vehicle Mount,                |              |
| Truck, Medium .....                             | 6            | Medium-Power .....                 | 4            |
| Truck, POL (5,000-Liter).....                   | 2            | HF, Manpack, Low-Power.....        | 2            |

**Materiel Support Battalion, Mech Inf Div  
or MD or Army or CDF or National**

---

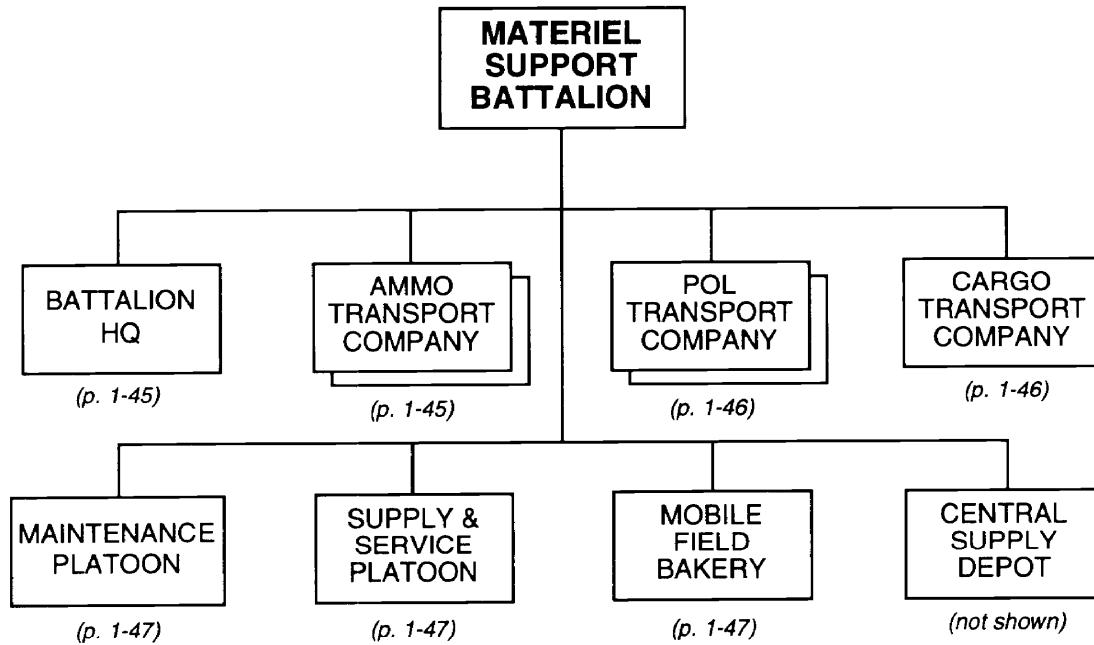

**PRINCIPAL ITEMS OF EQUIPMENT**

| <u>Equipment</u>               | <u>Total</u> |
|--------------------------------|--------------|
| SAM, Shoulder-Fired.....       | 2            |
| ATRL, RPG-18/22.....           | 17           |
| Truck, Utility .....           | 7            |
| Truck, Light .....             | 33           |
| Truck, Medium .....            | 158          |
| Truck, Crane .....             | 4            |
| Truck, Kitchen .....           | 2            |
| Truck, POL (5,000-Liter).....  | 100          |
| Truck, Water (900-Liter) ..... | 6            |
| Van, Maintenance .....         | 11           |
| Van, Mobile Field Bakery.....  | 4            |
| Van, Signal.....               | 1            |

| <u>Equipment</u>                 | <u>Total</u> |
|----------------------------------|--------------|
| Ambulance.....                   | 1            |
| Trailer, Cargo, 1-Axle.....      | 32           |
| Trailer, Cargo, 2-Axle.....      | 154          |
| Trailer, Generator.....          | 6            |
| Trailer, POL (4,200-Liter) ..... | 100          |
| Trailer, Water (900-Liter) ..... | 7            |
| Radios:                          |              |
| VHF, Manpack, Low-Power .....    | 5            |
| HF/VHF, Vehicle Mount,           |              |
| Medium-Power .....               | 1            |
| HF, Manpack, Low-Power.....      | 1            |
| Warning Receiver .....           | 1            |

Maintenance Battalion, Mech Inf Div or MD  
or MR or Army or CDF or National

---

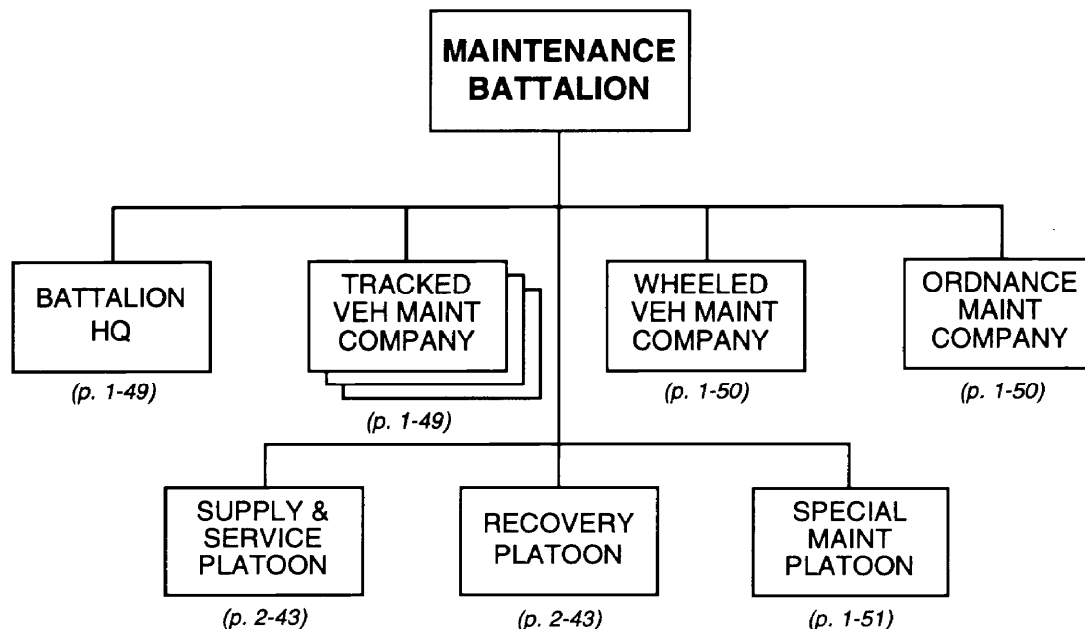

**PRINCIPAL ITEMS OF EQUIPMENT**

| <u>Equipment</u>                  | <u>Total</u> |
|-----------------------------------|--------------|
| ATRL, RPG-18/22.....              | 17           |
| Truck, Utility .....              | 7            |
| Truck, Light .....                | 4            |
| Truck, Medium .....               | 28           |
| Truck, Crane .....                | 5            |
| Truck, POL (5,000-Liter).....     | 6            |
| Truck, Recovery .....             | 2            |
| Truck, Water (2,000-Liter) .....  | 1            |
| Van, Light .....                  | 5            |
| Van, Maintenance .....            | 64           |
| Van, Signal.....                  | 1            |
| Armored Recovery Vehicle .....    | 5            |
| Ambulance .....                   | 1            |
| Tracked Amphibian, K-61/PTS ..... | 1            |
| Tractor, Artillery, AT-S .....    | 1            |
| Motorcycle .....                  | 3            |

| <u>Equipment</u>                 | <u>Total</u> |
|----------------------------------|--------------|
| Trailer, Cargo, 2-Axle.....      | 19           |
| Trailer, Generator.....          | 11           |
| Trailer, Kitchen.....            | 3            |
| Trailer, POL (4,200-Liter) ..... | 5            |
| Tractor-Trailer, Lowboy .....    | 2            |
| Trailer, Water (900-Liter) ..... | 1            |
| Radios:                          |              |
| VHF, Manpack, Low-Power.....     | 7            |
| VHF, Vehicle Mount,              |              |
| Medium-Power .....               | 7            |
| HF/VHF, Vehicle Mount,           |              |
| Medium-Power .....               | 1            |
| HF, Vehicle Mount,               |              |
| Medium-Power .....               | 1            |
| Warning Receiver .....           | 1            |

**Supply and Service Platoon, Maint Bn, Mech Inf Div  
or MD or MR or Army or CDF or National** \_\_\_\_\_

|   |
|---|
| <b>SUPPLY &amp;<br/>SERVICE<br/>PLATOON</b> |
|---|

**PRINCIPAL ITEMS OF EQUIPMENT**

| <u>Equipment</u>                 | <u>Total</u> | <u>Equipment</u>                     | <u>Total</u> |
|----------------------------------|--------------|--------------------------------------|--------------|
| ATRL, RPG-18/22.....             | 1            | Trailer, Cargo, 2-Axle.....          | 4            |
| Truck, Light .....               | 4            | Trailer, Kitchen.....                | 3            |
| Truck, Medium .....              | 10           | Trailer, POL (4,200-Liter) .....     | 6            |
| Truck, POL (5,000-Liter).....    | 6            | Trailer, Water (900-Liter) .....     | 1            |
| Truck, Water (2,000-Liter) ..... | 1            | Radio, VHF, Manpack, Low-Power ..... | 1            |
| Ambulance.....                   | 1            |                                      |              |

**Recovery Platoon, Maint Bn, Mech Inf Div  
or MD or MR or Army or CDF or National** \_\_\_\_\_

|                             |
|-----------------------------|
| <b>RECOVERY<br/>PLATOON</b> |
|-----------------------------|

**PRINCIPAL ITEMS OF EQUIPMENT**

| <u>Equipment</u>                  | <u>Total</u> | <u>Equipment</u>    | <u>Total</u> |
|-----------------------------------|--------------|---------------------|--------------|
| Truck, Recovery.....              | 2            | Radios:             |              |
| Tracked Amphibian, K-61/PTS ..... | 1            | VHF, Vehicle Mount, |              |
| Tractor, Artillery, AT-S .....    | 1            | Medium-Power .....  | 4            |
| Armored Recovery Vehicle .....    | 5            | HF, Vehicle Mount,  |              |
| Tractor-Trailer, Lowboy .....     | 2            | Medium-Power .....  | 1            |

Medical Battalion, Mech Inf Div, Mtzd Inf Div,  
and Inf Div, or MD or Army or CDF \_\_\_\_\_

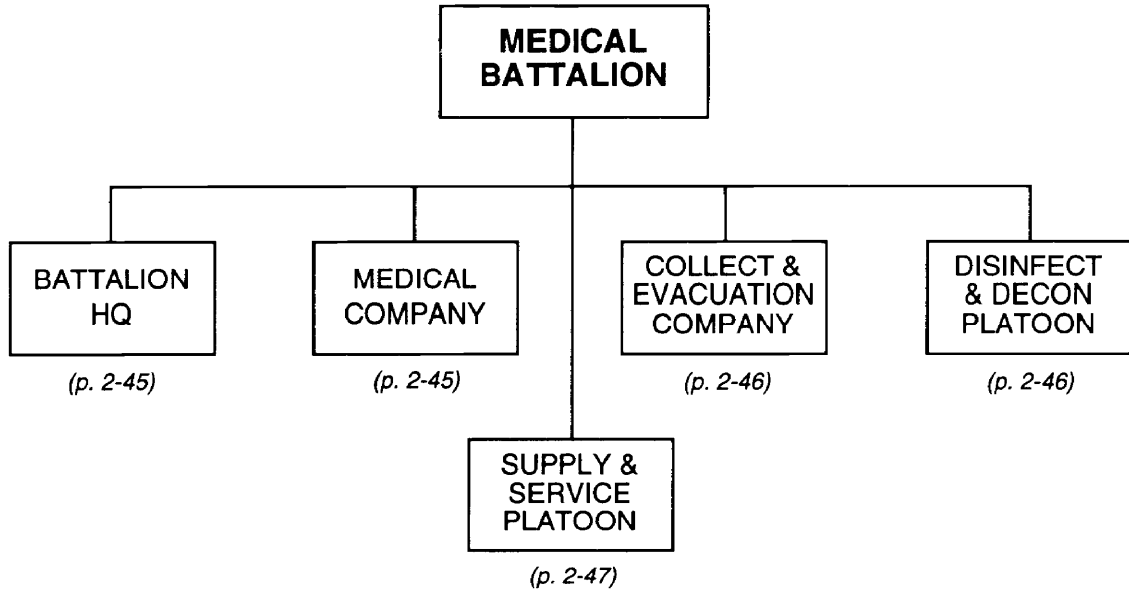

**PRINCIPAL ITEMS OF EQUIPMENT**

| <u>Equipment</u>                 | <u>Total</u> | <u>Equipment</u>                 | <u>Total</u> |
|----------------------------------|--------------|----------------------------------|--------------|
| Truck, Utility .....             | 6            | Trailer, Cargo, 2-Axle.....      | 10           |
| Truck, Light .....               | 4            | Trailer, Decon, DDP .....        | 1*           |
| Truck, Medium .....              | 21           | Trailer, Generator.....          | 3            |
| Truck, Decon, DDA-53/66 .....    | 1*           | Trailer, Kitchen .....           | 4            |
| Truck, Decon, ARS-12U/14 .....   | 3*           | Trailer, POL (4,200-Liter) ..... | 2            |
| Truck, POL (5,000-Liter).....    | 2            | Trailer, Water (900-Liter) ..... | 1            |
| Truck, Water (2,000-Liter) ..... | 3            | Radios:                          |              |
| Van, Generator.....              | 1            | VHF, Manpack, Low-Power.....     | 4            |
| Van, Hospital .....              | 9            | HF/VHF, Vehicle Mount,           |              |
| Van, Maintenance .....           | 2            | Medium-Power .....               | 1            |
| Van, Signal.....                 | 1            | HF, Manpack, Low-Power.....      | 1            |
| Ambulance .....                  | 12           | Warning Receiver .....           | 1            |

**FOOTNOTE:** \* Equipment totals here are most likely for the medical battalion in a motorized or mechanized infantry division, an expeditionary army, or the Capital Defense Forces. In an infantry division, there are more likely three DDA-53/66 trucks and three DDP trailers for personnel decontamination and only one ARS-12U/14 truck for vehicle decontamination.

**Battalion Headquarters, Med Bn** \_\_\_\_\_

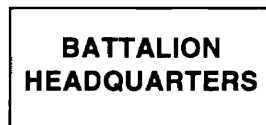

**PRINCIPAL ITEMS OF EQUIPMENT**

| <u>Equipment</u>     | <u>Total</u> | <u>Equipment</u>            | <u>Total</u> |
|----------------------|--------------|-----------------------------|--------------|
| Truck, Utility ..... | 1            | Radios:                     |              |
| Van, Signal.....     | 1            | HF/VHF, Vehicle Mount,      |              |
|                      |              | Medium-Power .....          | 1            |
|                      |              | HF, Manpack, Low-Power..... | 1            |
|                      |              | Warning Receiver .....      | 1            |

**Medical Company, Med Bn** \_\_\_\_\_

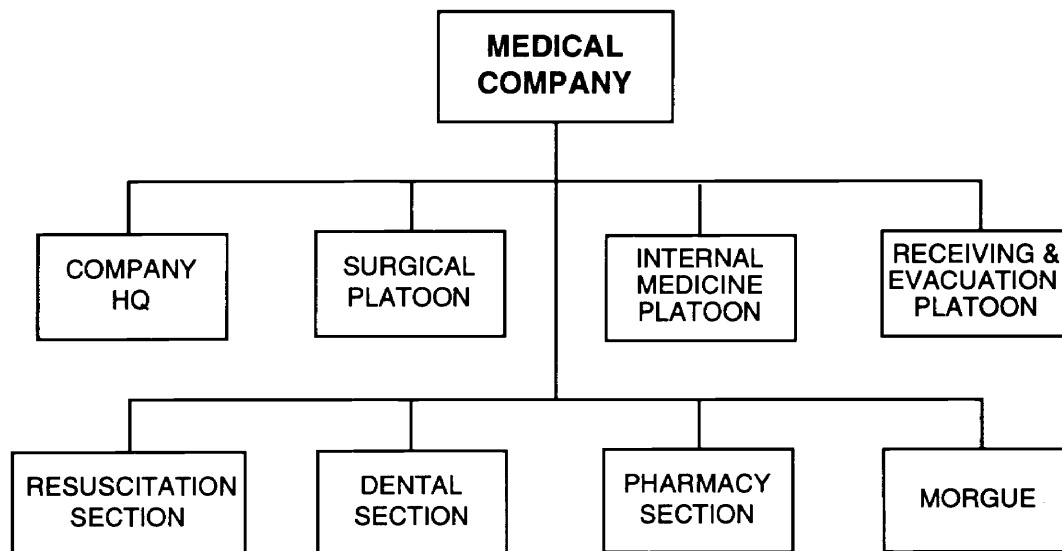

**PRINCIPAL ITEMS OF EQUIPMENT**

| <u>Equipment</u>     | <u>Total</u> | <u>Equipment</u>                     | <u>Total</u> |
|----------------------|--------------|--------------------------------------|--------------|
| Truck, Utility ..... | 2            | Trailer, Cargo, 2-Axle.....          | 7            |
| Truck, Light .....   | 1            | Trailer, Generator.....              | 2            |
| Truck, Medium* ..... | 7            | Radio, VHF, Manpack, Low-Power ..... | 1            |
| Van, Hospital .....  | 9            |                                      |              |

**FOOTNOTE:** \* In better-equipped units, additional hospital vans may replace these general-purpose cargo trucks.

**Collection and Evacuation Company,  
Med Bn**

---

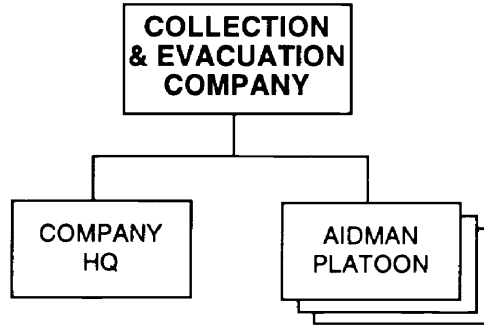

**PRINCIPAL ITEMS OF EQUIPMENT**

| <u>Equipment</u>     | <u>Total</u> | <u>Equipment</u>                     | <u>Total</u> |
|----------------------|--------------|--------------------------------------|--------------|
| Ambulance .....      | 12           | Truck, Light .....                   | 3            |
| Truck, Utility ..... | 1            | Radio, VHF, Manpack, Low-Power ..... | 1            |

**Disinfection and Decontamination Platoon,  
Med Bn**

---



**PRINCIPAL ITEMS OF EQUIPMENT**

| <u>Equipment</u>               | <u>Total</u> | <u>Equipment</u>                     | <u>Total</u> |
|--------------------------------|--------------|--------------------------------------|--------------|
| Truck, Utility .....           | 1            | Trailer, Decon, DDP .....            | 1*           |
| Truck, Decon, DDA-53/66 .....  | 1*           | Trailer, Water (900-Liter) .....     | 1            |
| Truck, Decon, ARS-12U/14 ..... | 3*           | Radio, VHF, Manpack, Low-Power ..... | 1            |
| Trailer, Cargo, 2-Axle .....   | 1            |                                      |              |

**FOOTNOTE:** \* Equipment totals here are most likely in the medical battalion in a motorized or mechanized infantry division, an expeditionary army, or the Capital Defense Forces. In an infantry division, there are more likely three DDA-53/66 trucks and three DDP trailers for personnel decontamination and only one ARS-12U/14 truck for vehicle decontamination.

Supply and Service Platoon,  
Med Bn \_\_\_\_\_

|  |
|--|
| <p><b>SUPPLY &amp;<br/>SERVICE<br/>PLATOON</b></p> |
|--|

**PRINCIPAL ITEMS OF EQUIPMENT**

| <u>Equipment</u>                 | <u>Total</u> | <u>Equipment</u>                     | <u>Total</u> |
|----------------------------------|--------------|--------------------------------------|--------------|
| Truck, Utility .....             | 1            | Trailer, Cargo, 2-Axle.....          | 2            |
| Truck, Medium .....              | 14           | Trailer, Generator.....              | 1            |
| Truck, POL (5,000-Liter).....    | 2            | Trailer, Kitchen.....                | 4            |
| Truck, Water (2,000-Liter) ..... | 3            | Trailer, POL (4,200-Liter) .....     | 2            |
| Van, Maintenance .....           | 2            | Radio, VHF, Manpack, Low-Power ..... | 1            |



## Chapter 3

# Motorized Infantry and Infantry Brigades

The basic maneuver unit is the **brigade**, consisting of maneuver battalions and a wide array of combat support and combat service support elements. <sup>1</sup> A **separate** brigade is not part of a division. Instead, it is directly subordinate to a military district or an army. In contrast, a **divisional** brigade is always part of a division.

**Motorized infantry** brigades are the most common in this infantry-based OPFOR. Such units differ from regular **infantry** primarily by having trucks available to transport all elements subordinate to the unit when necessary. The distinction between infantry and motorized infantry becomes clear only at brigade level, since the trucks for movement of infantry are organic to the motorized infantry brigade. Within either type of brigade, the basic maneuver units from squad through company are simply infantry. At battalion level, there are no organic trucks for transporting any infantry companies, although the infantry battalion headquarters has a few. The motorized infantry battalion also has some wheeled vehicles in its signal and logistics support elements. At battalion level and higher, subordinate units common to both infantry and motorized infantry have their basic entry under the motorized parent unit.

## CONTENTS

|  |      |
|--|------|
| <b>Motorized Infantry Brigade (Separate)</b> .....                                 | 3-3  |
| <b>Motorized Infantry Brigade (Divisional)</b> .....                               | 3-6  |
| Motorized Infantry Battalion, Mtzd Inf Bde (Sep and Div).....                      | 3-9  |
| Battalion Headquarters, Mtzd Inf Bn and Inf Bn.....                                | 3-10 |
| Infantry Company, Mtzd Inf Bn and Inf Bn.....                                      | 3-11 |
| Infantry Platoon, Inf Co.....  | 3-12 |
| Infantry Squad, Inf Plt.....   | 3-13 |
| Weapons Squad, Inf Plt or Abn Inf Plt.....   | 3-14 |
| Mortar Platoon, Inf Co and Commando Co.....  | 3-15 |
| Weapons Company, Mtzd Inf Bn and Inf Bn.....                                       | 3-16 |
| Mortar Platoon, Wpns Co, Mtzd Inf Bn and Inf Bn.....                               | 3-17 |
| SAM Platoon, Wpns Co, Mtzd Inf Bn and Inf Bn.....                                  | 3-18 |
| Antitank Platoon, Wpns Co, Mtzd Inf Bn and Inf Bn.....                             | 3-19 |
| Automatic Grenade Launcher Platoon, Wpns Co, Mtzd Inf Bn and Inf Bn.....           | 3-20 |
| Automatic Grenade Launcher Squad, AGL Plt, Wpns Co, Mtzd Inf Bn<br>and Inf Bn..... | 3-21 |
| Signal Platoon, Mtzd Inf Bn and Mech Inf Bn.....                                   | 3-21 |
| Supply and Service Platoon, Mtzd Inf Bn.....                                       | 3-22 |

---

<sup>1</sup>Some infantry-based forces may call the same organization a **regiment**. This difference in terminology **does not** signify a different structure or capability.

|  |      |
|--|------|
| Mortar Battalion, Mtzd Inf Bde (Div) and Inf Bde (Div) .....   | 3-23 |
| Mortar Battery, Mortar Bn or Mech Inf Bn or Mtzd Inf Bde (Sep),<br>Inf Bde (Sep and Militia), and Mech Inf Bde (Sep).....  | 3-24 |
| Mortar Platoon, Mortar Btry, Mortar Bn or Mech Inf Bn or Mtzd Inf Bde (Sep),<br>Inf Bde (Sep and Militia), and Mech Inf Bde (Sep).....   | 3-25 |
| Antiaircraft Gun Battery (23-mm), Mtzd Inf Bde (Sep and Div), Inf Bde (Sep, Div,<br>and Militia), and Abn Inf Bde, or Arty Regt or Arty Bde or MRL Bde<br>or SAM Bn (SA-4).....  | 3-26 |
| ATGM Battery, Mtzd Inf Bde (Sep), Inf Bde (Sep), and Mech Inf Bde (Sep and Div),<br>or Mtzd Inf Div, Inf Div, and Mech Inf Div .....   | 3-27 |
| ATGM Platoon, Mtzd Inf Bde (Div) and Inf Bde (Div).....  | 3-28 |
| Reconnaissance Platoon, Mtzd Inf Bde (Div) and Inf Bde (Div and Militia).....  | 3-29 |
| Reconnaissance Company, Mtzd Inf Bde (Sep) and Inf Bde (Sep),<br>or Mtzd Inf Div and Inf Div, or MD .....  | 3-30 |
| Company Headquarters, Recon Co, Mtzd Inf Bde (Sep) and Inf Bde (Sep),<br>or Mtzd Inf Div and Inf Div, or MD .....  | 3-30 |
| Reconnaissance Platoon, Recon Co, Mtzd Inf Bde (Sep) and Inf Bde (Sep),<br>or Mtzd Inf Div and Inf Div, or MD .....  | 3-31 |
| Motorcycle Platoon, Recon Co, Mtzd Inf Bde (Sep) Mech Inf Bde (APC) (Sep),<br>and Inf Bde (Sep), or Mtzd Inf Div and Inf Div, or MD.....   | 3-31 |
| Motorcycle Section, Motorcycle Plt, Recon Co,<br>or Recon Plt, Mtzd Inf Bde (Div) and Inf Bde (Div and Militia),<br>or Recon Co, Mech Inf Bde (IFV) (Sep) and Tank Bde,<br>or Signal Plt, Commando Bn .....  | 3-32 |
| Motor Transport Section, Recon Co, Mtzd Inf Div and Inf Div, or MD or Mtzd<br>Inf Bde (Sep) and Inf Bde (Sep and Militia).....   | 3-32 |
| Engineer Company, Mtzd Inf Bde (Sep and Div) and Inf Bde (Sep and Div),<br>or Mtzd Inf Div and Inf Div, or MD or MR .....  | 3-33 |
| Signal Company, Mtzd Inf Bde (Sep and Div) and Inf Bde (Sep and Div),<br>or Mtzd Inf Div and Inf Div, or MD .....  | 3-34 |
| Chemical Defense Platoon, Mtzd Inf Bde (Sep and Div), Mech Inf Bde (Sep and Div),<br>and Tank Bde, or Arty Regt or SP Arty Regt or Arty Bde or Air Defense Regt<br>or AA Gun Regt or MRL Bde or SAM Regt (SA-6 and SA-8)<br>or SAM Bde (SA-2, SA-3, SA-4, and SA-11) or Engr Bde ..... | 3-35 |
| Materiel Support Company, Mtzd Inf Bde (Sep and Div)<br>and Mech Inf Bde (Sep and Div) .....   | 3-36 |
| Maintenance Company, Mtzd Inf Bde (Sep and Div) or MD.....   | 3-37 |
| Motor Transport Battalion, Mtzd Inf Bde (Sep and Div) .....  | 3-38 |
| Troop Transport Company, Motor Transport Bn .....  | 3-39 |
| Weapons Transport Company, Motor Transport Bn .....  | 3-40 |
| Supply and Service Company, Motor Transport Bn.....  | 3-41 |
| Medical Platoon, Mtzd Inf Bde (Sep and Div), Inf Bde (Sep and Div), Mech Inf Bde<br>(Sep and Div), and Tank Bde, or Arty Regt or SP Arty Regt or Arty Bde or MRL<br>Bde or Engr Bde.....   | 3-42 |

**Infantry Brigade (Separate)**..... 3-43

**Infantry Brigade (Divisional)**..... 3-46

    Infantry Battalion, Inf Bde (Sep, Div, and Militia) or MD ..... 3-49

    Multiple Rocket Launcher Battery, Inf Bde (Sep and Div)  
    or Composite Arty Bn, Abn Inf Bde ..... 3-50

    Chemical Defense Platoon, Inf Bde (Sep and Div) ..... 3-51

    Materiel Support Company, Inf Bde (Sep and Div) ..... 3-52

    Maintenance Platoon, Inf Bde (Sep and Div) ..... 3-53

**Infantry Brigade (Militia)** ..... 3-54

    Supply and Service Platoon, Inf Bde (Militia)..... 3-56

**Motorized Infantry Brigade (Separate)** \_\_\_\_\_

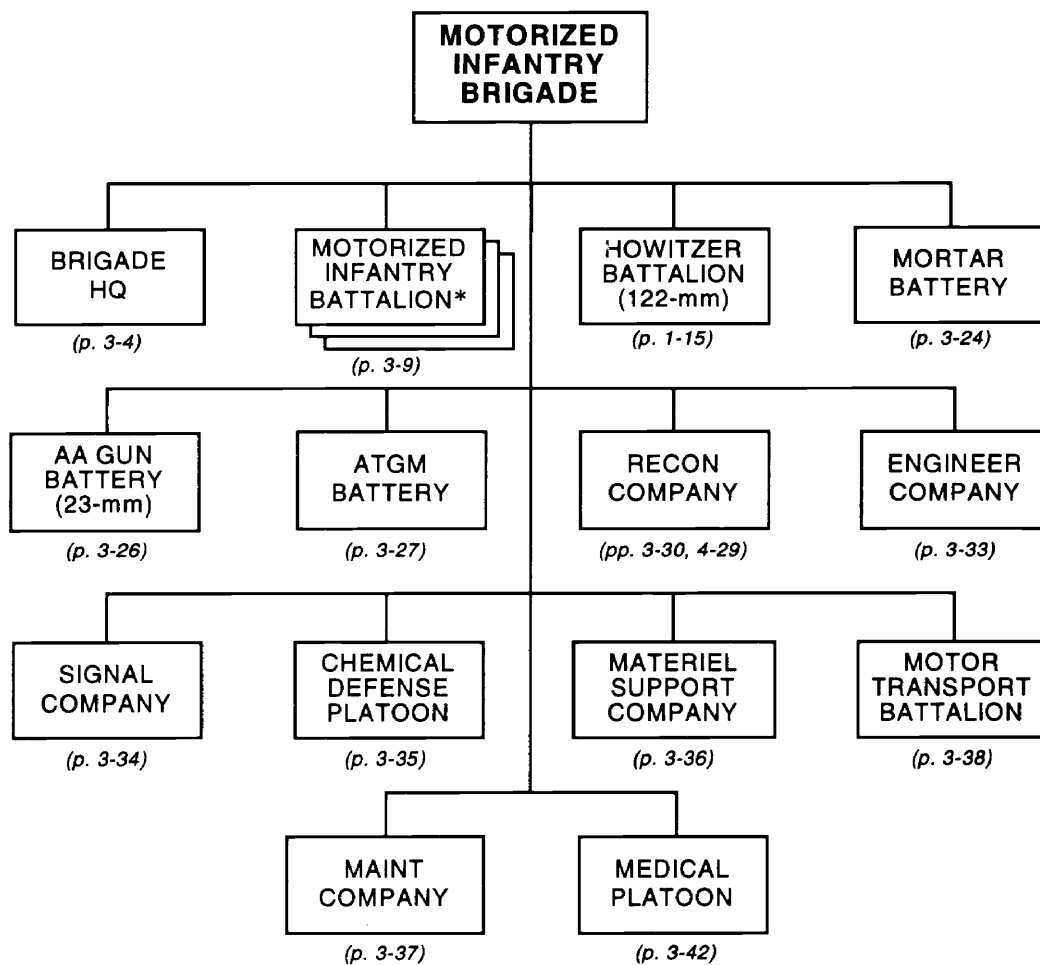

**FOOTNOTE:** \* In some new motorized infantry brigades, one of these infantry battalions may be mechanized rather than motorized.

(continued)

Motorized Infantry Brigade (Separate) (continued)

| Principal Items of Equipment                        | Brigade HQ | Motorized Inf Bn (3x) | Howitzer Bn (122-mm) | Mortar Battery | AA Gun Btry (23-mm) | ATGM Btry | Reconnaissance Co | Engineer Co | Signal Co | Chemical Defense Plt | Materiel Support Co | Motor Transport Bn | Maintenance Co | Medical Plt | TOTAL |
|---|------------|-----------------------|----------------------|----------------|---------------------|-----------|-------------------|-------------|-----------|----------------------|---------------------|--------------------|----------------|-------------|-------|
| <b>ARMORED VEHICLES</b>                             |            |                       |                      |                |                     |           |                   |             |           |                      |                     |                    |                |             |       |
| ACV, BRDM-2U  |            |                       |                      |                |                     | 4         |                   |             |           |                      |                     |                    |                |             | 4     |
| ACV, BTR (R-145BM)                                  |            | 3                     |                      |                |                     |           |                   |             |           |                      |                     |                    |                |             | 3     |
| Chemical Recon Vehicle, BRDM-2RKh                   |            |                       |                      |                |                     |           |                   |             |           | 3                    |                     |                    |                |             | 3     |
| ACRV, 1V18  |            |                       | 3                    |                |                     |           |                   |             |           |                      |                     |                    |                |             | 3     |
| ACRV, 1V19  |            |                       | 1                    |                |                     |           |                   |             |           |                      |                     |                    |                |             | 1     |
| <b>WEAPONS</b>                                      |            |                       |                      |                |                     |           |                   |             |           |                      |                     |                    |                |             |       |
| 30-mm Auto Grenade Lchr, AGS-17                     |            | 18                    |                      |                |                     |           |                   |             |           |                      |                     |                    |                |             | 18    |
| 60-mm Mortar, Light                                 |            | 27                    |                      |                |                     |           |                   |             |           |                      |                     |                    |                |             | 27    |
| 82-mm Mortar, M1937                                 |            | 9                     |                      |                |                     |           |                   |             |           |                      |                     |                    |                |             | 9     |
| 120-mm Mortar, M1943/2S12<br>or 82-mm Mortar, M1937 |            |                       |                      | 6              |                     |           |                   |             |           |                      |                     |                    |                |             |       |
| 122-mm Howitzer, D-30                               |            |                       | 18                   |                |                     |           |                   |             |           |                      |                     |                    |                |             | 18    |
| 73-mm Recoilless Gun, SPG-9                         |            | 6                     |                      |                |                     |           |                   |             |           |                      |                     |                    |                |             | 6     |
| ATGM Manpack, AT-7/SAXHORN                          |            | 9                     |                      |                |                     |           |                   |             |           |                      |                     |                    |                |             | 9     |
| ATGM Vehicle, w/AT-3/5                              |            |                       |                      |                |                     | 12        |                   |             |           |                      |                     |                    |                |             | 12    |
| 23-mm AA Gun, ZU-23                                 |            |                       |                      |                | 8                   |           |                   |             |           |                      |                     |                    |                |             | 8     |
| SAM, Shoulder-Fired                                 | 3          | 27                    | 18                   |                |                     |           |                   |             |           |                      |                     |                    |                |             | 48    |
| Flamethrower, LPO/RPO                               |            | 27                    |                      |                |                     |           |                   | 4           |           |                      |                     |                    |                |             | 31    |
| <b>ENGINEER EQUIPMENT</b>                           |            |                       |                      |                |                     |           |                   |             |           |                      |                     |                    |                |             |       |
| Bridge, Truck-Launched                              |            |                       |                      |                |                     |           |                   | 4           |           |                      |                     |                    |                |             | 4     |
| Minelayer, PMR-3                                    |            |                       |                      |                |                     |           |                   | 3           |           |                      |                     |                    |                |             | 3     |
| Mine Detector, DIM                                  |            |                       |                      |                |                     |           |                   | 1           |           |                      |                     |                    |                |             | 1     |
| Truck, Water Purification                           |            |                       |                      |                |                     |           |                   | 1           |           |                      |                     |                    |                |             | 1     |
| <b>TRUCKS</b>                                       |            |                       |                      |                |                     |           |                   |             |           |                      |                     |                    |                |             |       |
| ACRV, 1V110 (Battery FDC)                           |            |                       | 3                    |                |                     |           |                   |             |           |                      |                     |                    |                |             | 3     |
| ACRV, 1V111 (Battalion FDC)                         |            |                       | 1                    |                |                     |           |                   |             |           |                      |                     |                    |                |             | 1     |
| Truck, Utility                                      | 2          | 6                     | 1                    | 1              | 1                   |           | 1                 | 4           | 5         |                      | 2                   | 14                 | 1              |             | 38    |
| Truck, Light  | 6          | 30                    | 9                    | 7              | 8                   |           |                   |             | 3         |                      | 4                   | 39                 |                | 1           | 107   |
| Truck, Medium                                       |            | 6                     | 34                   |                |                     | 3         | 3                 | 9           |           |                      | 45                  | 60                 | 2              | 2           | 164   |
| Truck, Crane  |            |                       |                      |                |                     |           |                   | 2           |           |                      |                     | 1                  | 1              |             | 4     |
| Truck, Decon, ARS-12U/14                            |            |                       |                      |                |                     |           |                   |             |           | 3                    |                     |                    |                |             | 3     |
| Truck, Decon, DDA-53/66                             |            |                       |                      |                |                     |           |                   |             |           | 1                    |                     |                    |                | 1           | 2     |
| Truck, Dump   |            |                       |                      |                |                     |           |                   | 2           |           |                      |                     |                    |                |             | 2     |
| Truck, POL (5,000-L)                                |            |                       | 2                    |                |                     |           |                   |             |           |                      | 15                  | 4                  |                |             | 21    |
| Truck, Recovery                                     |            |                       |                      |                |                     |           |                   |             |           |                      |                     |                    | 2              |             | 2     |
| Truck, Water (2,000-L)                              |            |                       |                      |                |                     |           |                   |             |           | 2                    | 4                   |                    |                |             | 6     |
| Van, Command  | 3          |                       |                      |                |                     |           |                   |             |           |                      |                     |                    |                |             | 3     |
| Van, Hospital                                       |            |                       |                      |                |                     |           |                   |             |           |                      |                     |                    |                | 1           | 1     |
| Van, Kitchen  |            | 3                     |                      |                |                     |           |                   |             |           |                      |                     |                    |                |             | 3     |
| Van, Maintenance                                    |            |                       | 1                    |                |                     |           |                   | 1           |           |                      | 1                   | 1                  | 9              |             | 13    |
| Van, Signal   |            | 3                     | 4                    |                |                     |           |                   | 1           | 10        |                      |                     | 1                  |                |             | 19    |
| Ambulance   |            | 3                     | 1                    |                |                     |           |                   |             |           |                      |                     | 1                  |                | 4           | 9     |
| <b>TRAILERS</b>                                     |            |                       |                      |                |                     |           |                   |             |           |                      |                     |                    |                |             |       |
| Trailer, Cargo, 1-Axle                              |            |                       |                      |                |                     |           |                   | 6           |           |                      |                     | 2                  |                |             | 8     |
| Trailer, Cargo, 2-Axle                              |            | 3                     | 11                   |                |                     |           |                   | 2           |           |                      | 30                  | 4                  | 4              |             | 54    |
| Trailer, Generator                                  |            |                       | 1                    |                |                     |           |                   |             | 1         |                      | 1                   | 6                  | 2              |             | 11    |
| Trailer, Kitchen                                    |            | 9                     | 4                    |                |                     |           |                   | 1           |           |                      | 2                   | 3                  |                |             | 19    |
| Trailer, POL (4,200-L)                              |            | 3                     | 2                    |                |                     |           |                   |             |           |                      | 15                  | 4                  |                |             | 24    |
| Trailer, Water (900-/1,200-L)                       |            | 3                     | 1                    |                |                     |           |                   | 1           |           | 2                    | 1                   | 3                  |                |             | 11    |

(continued)

Motorized Infantry Brigade (Separate) (continued)

| <i>Principal Items of Equipment</i>                                | <i>Brigade HQ</i> | <i>Motorized Inf Bn (3x)</i> | <i>Howitzer Bn (122-mm)</i> | <i>Mortar Battery</i> | <i>AA Gun Btry (23-mm)</i> | <i>ATGM Btry</i> | <i>Reconnaissance Co</i> | <i>Engineer Co</i> | <i>Signal Co</i> | <i>Chemical Defense Plt</i> | <i>Materiel Support Co</i> | <i>Motor Transport Bn</i> | <i>Maintenance Co</i> | <i>Medical Plt</i> | <i>TOTAL</i> |     |
|--|-------------------|------------------------------|-----------------------------|-----------------------|----------------------------|------------------|--------------------------|--------------------|------------------|-----------------------------|----------------------------|---------------------------|-----------------------|--------------------|--------------|-----|
| <b>RADARS</b>  |                   |                              |                             |                       |                            |                  |                          |                    |                  |                             |                            |                           |                       |                    |              |     |
| Radar, Battlefield Surveillance, Man-Portable, PSNR-1 or TALL MIKE |                   |                              | 1                           |                       |                            | 1                | 3                        |                    |                  |                             |                            |                           |                       |                    |              | 5   |
| <b>RADIOS</b>  |                   |                              |                             |                       |                            |                  |                          |                    |                  |                             |                            |                           |                       |                    |              |     |
| VHF, Manpack, Low-Power  | 3                 | 201                          | 14                          | 5                     | 3                          | 4                | 11                       | 4                  | 7                |                             |                            | 3                         | 1                     | 1                  |              | 257 |
| VHF, Portable, Low-Power   |                   | 51                           | 23                          |                       |                            |                  | 4                        |                    |                  |                             |                            |                           |                       |                    |              | 78  |
| VHF, Portable, Very-Low-Power                                      |                   | 12                           |                             |                       |                            |                  |                          |                    |                  |                             |                            |                           |                       |                    |              | 12  |
| VHF, Vehicle Mount, Medium-Power                                   | 3                 | 9                            | 8                           | 1                     |                            | 16               | 1                        | 1                  |                  | 3                           |                            | 6                         | 2                     |                    |              | 50  |
| HF, Manpack, Low-Power   |                   | 3                            |                             |                       |                            |                  |                          |                    | 2                | 1                           | 1                          | 1                         |                       |                    |              | 8   |
| HF, Vehicle Mount, Medium-Power                                    | 1                 |                              |                             |                       |                            |                  | 1                        | 1                  | 2                |                             |                            |                           |                       |                    |              | 5   |
| HF/VHF, Vehicle Mount, Med-Power                                   |                   | 3                            | 4                           |                       |                            |                  |                          |                    | 8                |                             |                            | 1                         |                       |                    |              | 16  |
| HF/VHF, Vehicle Mount, High-Power                                  |                   |                              |                             |                       |                            |                  |                          |                    | 2                |                             |                            |                           |                       |                    |              | 2   |
| HF, Vehicle Mount, High-Power                                      |                   | 3                            |                             |                       |                            |                  |                          |                    | 1                |                             |                            |                           |                       |                    |              | 4   |
| Radio Relay, VHF/UHF   |                   |                              |                             |                       |                            |                  |                          |                    | 2                |                             |                            |                           |                       |                    |              | 2   |
| Warning Receiver   | 1                 | 3                            | 1                           |                       |                            |                  | 1                        |                    | 3                |                             |                            | 1                         |                       |                    |              | 10  |
| <b>MISCELLANEOUS</b>   |                   |                              |                             |                       |                            |                  |                          |                    |                  |                             |                            |                           |                       |                    |              |     |
| Rangefinder, Stereoscopic  |                   | 3                            |                             | 1                     |                            | 1                |                          |                    |                  |                             |                            |                           |                       |                    |              | 5   |
| Rangefinder, Laser, SAGE GLOSS                                     |                   |                              | 4                           |                       |                            |                  |                          |                    |                  |                             |                            |                           |                       |                    |              | 4   |
| Periscopic Aiming Circle, PAB2A                                    |                   | 3                            |                             | 1                     |                            |                  |                          |                    |                  |                             |                            |                           |                       |                    |              | 4   |
| Collimator   |                   | 9                            |                             | 6                     |                            |                  |                          |                    |                  |                             |                            |                           |                       |                    |              | 15  |
| Motorcycle   |                   |                              |                             |                       |                            |                  | 9                        |                    | 3                |                             |                            |                           |                       |                    |              | 12  |

Motorized Infantry Brigade (Divisional) \_\_\_\_\_

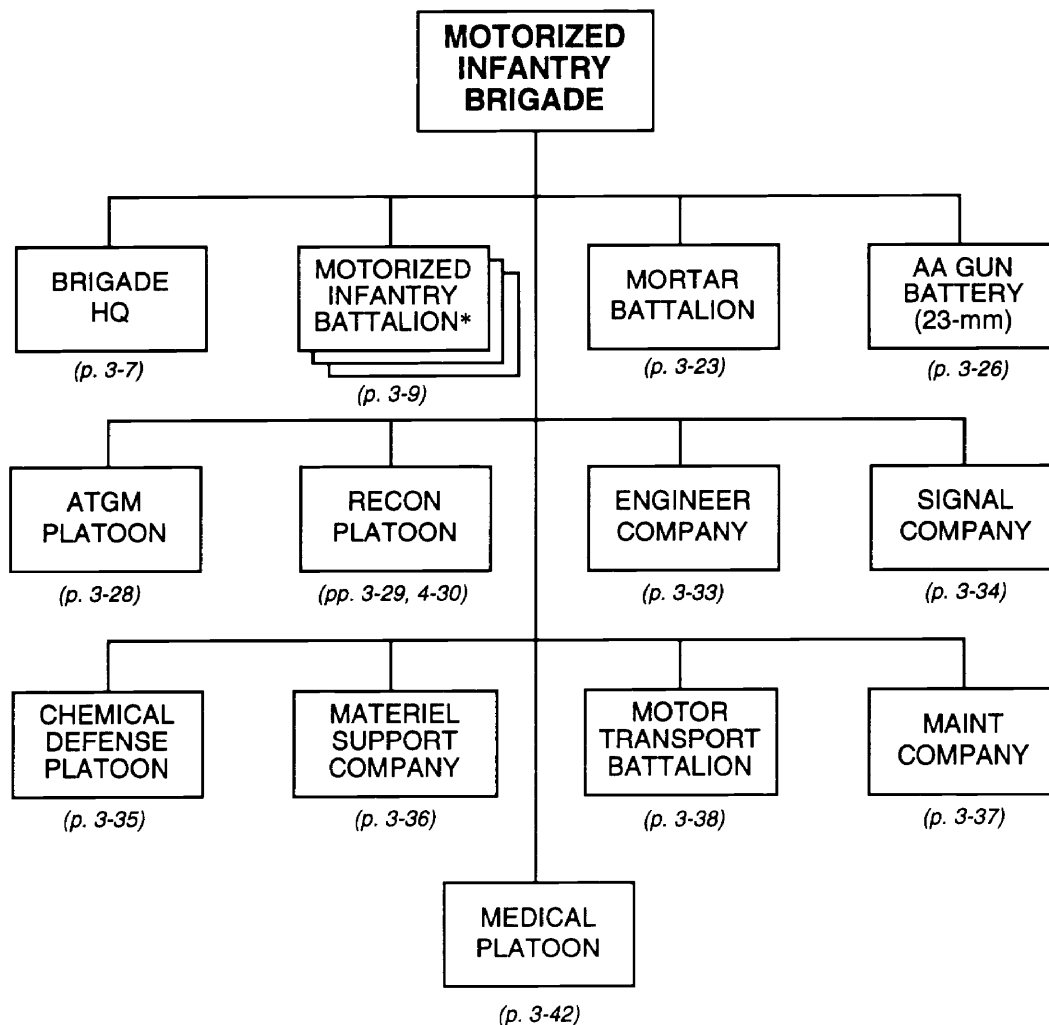

**FOOTNOTE:** \* In some motorized infantry brigades, one of these infantry battalions may be mechanized rather than motorized.

(continued)

Motorized Infantry Brigade (Divisional) (continued)

| Principal Items of Equipment                        | Brigade HQ | Motorized Inf Bn (3x) | Mortar Bn | AA Gun Btry (23-mm) | ATGM Plt | Reconnaissance Plt | Engineer Co | Signal Co | Chemical Defense Plt | Material Support Co | Motor Transport Bn | Maintenance Co | Medical Plt | TOTAL |
|---|------------|-----------------------|-----------|---------------------|----------|--------------------|-------------|-----------|----------------------|---------------------|--------------------|----------------|-------------|-------|
| <b>ARMORED VEHICLES</b>                             |            |                       |           |                     |          |                    |             |           |                      |                     |                    |                |             |       |
| ACV, BTR (R-145BM)                                  |            | 3                     |           |                     |          |                    |             |           |                      |                     |                    |                |             | 3     |
| Chemical Recon Vehicle, BRDM-2RKh                   |            |                       |           |                     |          |                    |             |           | 3                    |                     |                    |                |             | 3     |
| <b>WEAPONS</b>                                      |            |                       |           |                     |          |                    |             |           |                      |                     |                    |                |             |       |
| 30-mm Auto Grenade Lchr, AGS-17                     |            | 18                    |           |                     |          |                    |             |           |                      |                     |                    |                |             | 18    |
| 60-mm Mortar, Light                                 |            | 27                    |           |                     |          |                    |             |           |                      |                     |                    |                |             | 27    |
| 82-mm Mortar, M1937                                 |            | 9                     |           |                     |          |                    |             |           |                      |                     |                    |                |             | 9     |
| 120-mm Mortar, M1943/2S12<br>or 82-mm Mortar, M1937 |            |                       | 18        |                     |          |                    |             |           |                      |                     |                    |                |             | 18    |
| 73-mm Recoilless Gun, SPG-9                         |            | 6                     |           |                     |          |                    |             |           |                      |                     |                    |                |             | 6     |
| ATGM Manpack, AT-4/SPIGOT                           |            |                       |           |                     | 6        |                    |             |           |                      |                     |                    |                |             | 6     |
| ATGM Manpack, AT-7/SAXHORN                          |            | 9                     |           |                     |          |                    |             |           |                      |                     |                    |                |             | 9     |
| 23-mm AA Gun, ZU-23                                 |            |                       |           | 8                   |          |                    |             |           |                      |                     |                    |                |             | 8     |
| SAM, Shoulder-Fired                                 | 3          | 27                    |           |                     |          |                    |             |           |                      |                     |                    |                |             | 30    |
| Flamethrower, LPO/RPO                               |            | 27                    |           |                     |          |                    | 4           |           |                      |                     |                    |                |             | 31    |
| <b>ENGINEER EQUIPMENT</b>                           |            |                       |           |                     |          |                    |             |           |                      |                     |                    |                |             |       |
| Bridge, Truck-Launched                              |            |                       |           |                     |          |                    | 4           |           |                      |                     |                    |                |             | 4     |
| Minelayer, PMR-3                                    |            |                       |           |                     |          |                    | 3           |           |                      |                     |                    |                |             | 3     |
| Mine Detector, DIM                                  |            |                       |           |                     |          |                    | 1           |           |                      |                     |                    |                |             | 1     |
| Truck, Water Purification                           |            |                       |           |                     |          |                    | 1           |           |                      |                     |                    |                |             | 1     |
| <b>TRUCKS</b>                                       |            |                       |           |                     |          |                    |             |           |                      |                     |                    |                |             |       |
| Truck, Utility                                      | 2          | 6                     | 3         | 1                   |          |                    | 4           | 5         |                      | 2                   | 14                 | 1              |             | 38    |
| Truck, Light  | 6          | 30                    | 23        | 8                   | 3        |                    |             | 3         |                      | 4                   | 39                 |                | 1           | 117   |
| Truck, Medium                                       |            | 6                     |           |                     |          | 1                  | 9           |           |                      | 45                  | 60                 | 2              | 2           | 125   |
| Truck, Crane  |            |                       |           |                     |          |                    | 2           |           |                      |                     | 1                  | 1              |             | 4     |
| Truck, Decon, ARS-12U/14                            |            |                       |           |                     |          |                    |             |           | 3                    |                     |                    |                |             | 3     |
| Truck, Decon, DDA-53/66                             |            |                       |           |                     |          |                    |             |           | 1                    |                     |                    |                | 1           | 2     |
| Truck, Dump   |            |                       |           |                     |          |                    | 2           |           |                      |                     |                    |                |             | 2     |
| Truck, POL (5,000-L)                                |            |                       | 1         |                     |          |                    |             |           |                      | 15                  | 4                  |                |             | 20    |
| Truck, Recovery                                     |            |                       |           |                     |          |                    |             |           |                      |                     |                    | 2              |             | 2     |
| Truck, Water (2,000-L)                              |            |                       |           |                     |          |                    |             |           | 2                    | 4                   |                    |                |             | 6     |
| Van, Command  | 3          |                       |           |                     |          |                    |             |           |                      |                     |                    |                |             | 3     |
| Van, Hospital                                       |            |                       |           |                     |          |                    |             |           |                      |                     |                    |                | 1           | 1     |
| Van, Kitchen  |            | 3                     |           |                     |          |                    |             |           |                      |                     |                    |                |             | 3     |
| Van, Maintenance                                    |            |                       | 1         |                     |          |                    | 1           |           |                      | 1                   | 1                  | 9              |             | 13    |
| Van, Signal   |            | 3                     | 1         |                     |          |                    | 1           | 10        |                      |                     | 1                  |                |             | 16    |
| Ambulance   |            | 3                     | 1         |                     |          |                    |             |           |                      |                     | 1                  |                | 4           | 9     |
| <b>TRAILERS</b>                                     |            |                       |           |                     |          |                    |             |           |                      |                     |                    |                |             |       |
| Trailer, Cargo, 1-Axle                              |            |                       |           |                     |          |                    | 6           |           |                      |                     | 2                  |                |             | 8     |
| Trailer, Cargo, 2-Axle                              |            | 3                     | 4         |                     |          |                    | 2           |           |                      | 30                  | 4                  | 4              |             | 47    |
| Trailer, Generator                                  |            |                       | 1         |                     |          |                    |             | 1         |                      | 1                   | 6                  | 2              |             | 11    |
| Trailer, Kitchen                                    |            | 9                     | 3         |                     |          |                    | 1           |           |                      | 2                   | 3                  |                |             | 18    |
| Trailer, POL (1,200-L)                              |            |                       | 1         |                     |          |                    |             |           |                      |                     |                    |                |             | 1     |
| Trailer, POL (4,200-L)                              |            | 3                     |           |                     |          |                    |             |           |                      | 15                  | 4                  |                |             | 22    |
| Trailer, Water (900-/1,200-L)                       |            | 3                     | 1         |                     |          |                    | 1           |           | 2                    | 1                   | 3                  |                |             | 11    |

(continued)

Motorized Infantry Brigade (Divisional) (continued)

| <i>Principal Items of Equipment</i>                                | <i>Brigade HQ</i> | <i>Motorized Inf Bn (3x)</i> | <i>Mortar Bn</i> | <i>AA Gun Btry (23-mm)</i> | <i>ATGM Plt</i> | <i>Reconnaissance Plt</i> | <i>Engineer Co</i> | <i>Signal Co</i> | <i>Chemical Defense Plt</i> | <i>Materiel Support Co</i> | <i>Motor Transport Bn</i> | <i>Maintenance Co</i> | <i>Medical Plt</i> | <i>TOTAL</i> |
|--|-------------------|------------------------------|------------------|----------------------------|-----------------|---------------------------|--------------------|------------------|-----------------------------|----------------------------|---------------------------|-----------------------|--------------------|--------------|
| <b>RADARS</b>  |                   |                              |                  |                            |                 |                           |                    |                  |                             |                            |                           |                       |                    |              |
| Radar, Battlefield Surveillance, Man-Portable, PSNR-1 or TALL MIKE |                   |                              | 1                |                            |                 | 1                         |                    |                  |                             |                            |                           |                       |                    | 2            |
| <b>RADIOS</b>  |                   |                              |                  |                            |                 |                           |                    |                  |                             |                            |                           |                       |                    |              |
| VHF, Manpack, Low-Power  | 3                 | 201                          | 18               | 3                          | 3               | 3                         | 4                  | 7                |                             |                            | 3                         | 1                     | 1                  | 247          |
| VHF, Portable, Low-Power   |                   | 51                           | 2                |                            | 4               | 1                         |                    |                  |                             |                            |                           |                       |                    | 58           |
| VHF, Portable, Very-Low-Power                                      |                   | 12                           |                  |                            |                 |                           |                    |                  |                             |                            |                           |                       |                    | 12           |
| VHF, Vehicle Mount, Medium-Power                                   | 3                 | 9                            | 3                |                            |                 |                           | 1                  |                  | 3                           |                            | 6                         | 2                     |                    | 27           |
| HF, Manpack, Low-Power   |                   | 3                            |                  |                            |                 |                           |                    | 2                | 1                           | 1                          | 1                         |                       |                    | 8            |
| HF, Vehicle Mount, Medium-Power                                    | 1                 |                              |                  |                            |                 |                           | 1                  | 2                |                             |                            |                           |                       |                    | 4            |
| HF/VHF, Vehicle Mount, Med-Power                                   |                   | 3                            | 1                |                            |                 |                           |                    | 8                |                             |                            | 1                         |                       |                    | 13           |
| HF/VHF, Vehicle Mount, High-Power                                  |                   |                              |                  |                            |                 |                           |                    | 2                |                             |                            |                           |                       |                    | 2            |
| HF, Vehicle Mount, High-Power                                      |                   | 3                            |                  |                            |                 |                           |                    | 1                |                             |                            |                           |                       |                    | 4            |
| Radio Relay, VHF/UHF   |                   |                              |                  |                            |                 |                           |                    | 2                |                             |                            |                           |                       |                    | 2            |
| Warning Receiver   | 1                 | 3                            | 1                |                            |                 |                           |                    | 3                |                             |                            | 1                         |                       |                    | 9            |
| <b>MISCELLANEOUS</b>   |                   |                              |                  |                            |                 |                           |                    |                  |                             |                            |                           |                       |                    |              |
| Rangefinder, Stereoscopic  |                   | 3                            | 3                |                            |                 |                           |                    |                  |                             |                            |                           |                       |                    | 6            |
| Rangefinder, Laser, SAGE GLOSS                                     |                   |                              |                  |                            |                 |                           |                    |                  |                             |                            |                           |                       |                    | 0            |
| Periscopic Aiming Circle, PAB2A                                    |                   | 3                            | 3                |                            |                 |                           |                    |                  |                             |                            |                           |                       |                    | 6            |
| Collimator   |                   | 9                            | 18               |                            |                 |                           |                    |                  |                             |                            |                           |                       |                    | 27           |
| Motorcycle   |                   |                              |                  |                            |                 | 3                         |                    | 3                |                             |                            |                           |                       |                    | 6            |



**Motorized Infantry Battalion,  
Mtzd Inf Bde (Sep and Div)**

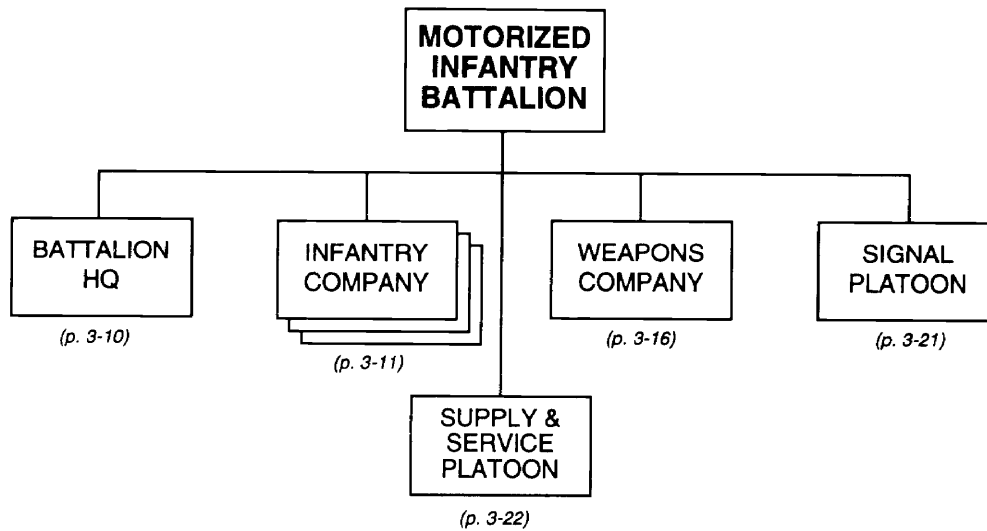

**PRINCIPAL ITEMS OF EQUIPMENT**

| <u>Equipment</u>                                   | <u>Total</u> |
|--|--------------|
| ACV, BTR (R-145 BM) .....                          | 1            |
| 9-mm Pistol, PM.....                               | 113          |
| 5.45-mm Assault Rifle, AK-74.....                  | 351          |
| 5.45-mm LMG, RPK-74 .....                          | 54           |
| 7.62-mm Sniper Rifle, SVD .....                    | 9            |
| 7.62-mm GP MG, PKM.....                            | 27           |
| 40-mm Under-Barrel Grenade Launcher,<br>BG-15..... | 79           |
| 30-mm Automatic Grenade Launcher,<br>AGS-17 .....  | 6            |
| 60-mm Mortar, Light .....                          | 9            |
| 82-mm Mortar, M1937 .....                          | 3            |
| SAM, Shoulder-Fired.....                           | 9            |
| ATGM Manpack, AT-7/SAXHORN.....                    | 3            |
| 73-mm Recoilless Gun, SPG-9.....                   | 2            |
| ATGL, RPG-7V.....                                  | 45           |
| ATRL, RPG-18/22.....                               | 75           |
| Flamethrower, LPO/RPO.....                         | 9            |
| Truck, Utility .....                               | 2            |
| Truck, Light .....                                 | 10           |
| Truck, Medium .....                                | 2            |
| Van, Kitchen .....                                 | 1            |
| Van, Signal.....                                   | 1            |
| Ambulance .....                                    | 1            |

| <u>Equipment</u>                             | <u>Total</u> |
|--|--------------|
| Trailer, Cargo, 2-Axle.....                  | 1            |
| Trailer, Kitchen.....                        | 3            |
| Trailer, POL (4,200-Liter) .....             | 1            |
| Trailer, Water (900- or 1,200-Liter) .....   | 1            |
| Rangefinder, Stereoscopic, DS-1 .....        | 1            |
| Periscopic Aiming Circle, PAB2A .....        | 1            |
| Collimator .....                             | 3            |
| Night-Vision Goggles .....                   | 48           |
| Night-Vision Goggles (Driver) .....          | 6            |
| Night-Vision Sight (AGL) .....               | 6            |
| Night-Vision Sight (MG).....                 | 27           |
| Night-Vision Sight (Small Arms).....         | 65           |
| Radios:                                      |              |
| VHF, Manpack, Low-Power .....                | 67           |
| VHF, Portable, Low-Power .....               | 17           |
| VHF, Portable, Very-Low-Power .....          | 4            |
| VHF, Vehicle Mount,<br>Medium-Power .....    | 3            |
| HF, Manpack, Low-Power.....                  | 1            |
| HF/VHF, Vehicle Mount,<br>Medium-Power ..... | 1            |
| HF, Vehicle Mount,<br>Medium-Power .....     | 1            |
| Warning Receiver .....                       | 1            |

**(continued)**

**Motorized Infantry Battalion, Mtzd Inf Bde (Sep and Div) (continued) \_\_\_\_\_**

**NOTES:**

1. A motorized infantry battalion does not have organic transport assets to move its infantry companies and weapons company. Rather, it relies on the brigade-level motor transport battalion (p. 3-38) to provide trucks for movement over longer distances. Movement of all 3 infantry companies requires a total of 18 medium trucks. A weapons company requires 3 utility trucks and 12 light trucks.
2. Some motorized infantry battalions may have a mortar battery with nine 82-mm mortars (p. 3-24) instead of a mortar platoon in the weapons company. In that case, there would probably be no 60-mm mortars in the infantry companies

**Battalion Headquarters, Mtzd Inf Bn  
and Inf Bn \_\_\_\_\_**

**BATTALION  
HEADQUARTERS**

**PRINCIPAL ITEMS OF EQUIPMENT**

| <u>Equipment</u>                                   | <u>Total</u> | <u>Equipment</u>                          | <u>Total</u> |
|--|--------------|---|--------------|
| 9-mm Pistol, PM.....                               | 4            | Radios:                                   |              |
| 5.45-mm Assault Rifle, AK-74.....                  | 8            | VHF, Manpack, Low-Power.....              | 2            |
| 40-mm Under-Barrel Grenade Launcher,<br>BG-15..... | 2            | VHF, Portable, Low-Power .....            | 2            |
| Truck, Utility .....                               | 1            | VHF, Vehicle Mount,<br>Medium-Power ..... | 1            |
| Truck, Light .....                                 | 3            | HF, Vehicle Mount,<br>Medium-Power .....  | 1            |
| Night-Vision Goggles (Driver).....                 | 1            | Warning Receiver .....                    | 1            |
| Night-Vision Sight (Small Arms).....               | 2            |   |              |

Infantry Company, Mtzd Inf Bn and Inf Bn

---

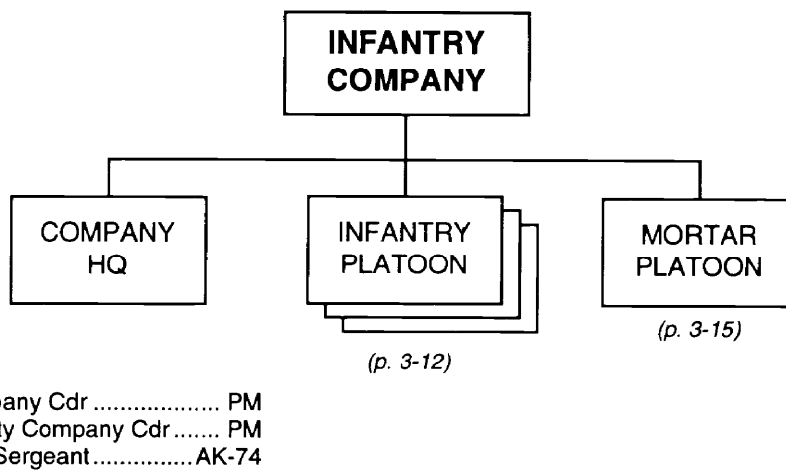

**PRINCIPAL ITEMS OF EQUIPMENT**

| <u>Equipment</u>                                   | <u>Total</u> | <u>Equipment</u>                        | <u>Total</u> |
|--|--------------|---|--------------|
| 9-mm Pistol, PM.....                               | 29           | ATRL, RPG-18/22.....                    | 22           |
| 5.45-mm Assault Rifle, AK-74.....                  | 82           | Flamethrower, LPO/RPO.....              | 3            |
| 5.45-mm LMG, RPK-74.....                           | 18           | Night-Vision Goggles.....               | 16           |
| 7.62-mm Sniper Rifle, SVD.....                     | 3            | Night-Vision Sight (Small Arms).....    | 15           |
| 7.62-mm GP MG, PKM.....                            | 9            | Night-Vision Sight (MG).....            | 9            |
| 40-mm Under-Barrel Grenade Launcher,<br>BG-15..... | 23           | Radios:<br>VHF, Manpack, Low-Power..... | 16           |
| 60-mm Mortar, Light.....                           | 3            | VHF, Portable, Low-Power.....           | 5            |
| ATGL, RPG-7V.....                                  | 15           |   |              |

*NOTE:* An infantry company in a motorized infantry battalion does not have organic transportation assets. Rather, it relies on the brigade-level troop transport company (p. 3-39) to provide trucks for troop transport. Movement of an infantry company requires six medium trucks.

Infantry Platoon, Inf Co \_\_\_\_\_

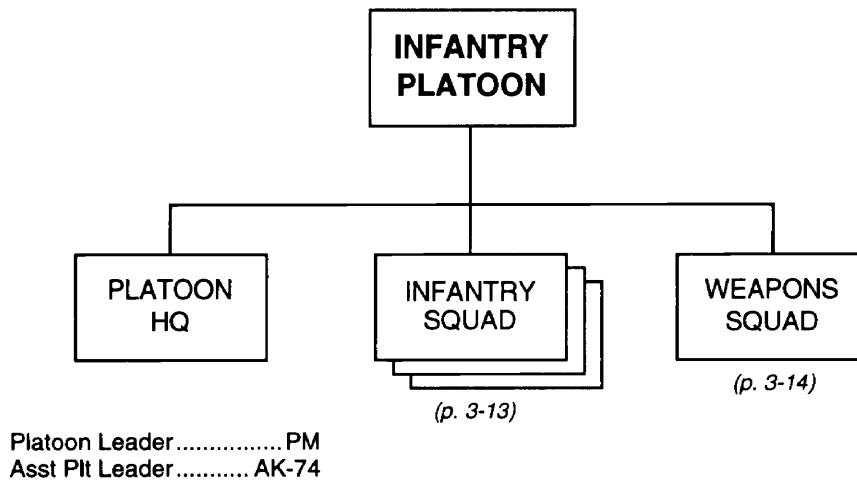

**PRINCIPAL ITEMS OF EQUIPMENT**

| <u>Equipment</u>                                   | <u>Total</u> | <u>Equipment</u>                     | <u>Total</u> |
|--|--------------|--------------------------------------|--------------|
| 9-mm Pistol, PM.....                               | 9            | ATGL, RPG-7V.....                    | 5            |
| 5.45-mm Assault Rifle, AK-74.....                  | 23           | ATRL, RPG-18/22.....                 | 6            |
| 5.45-mm LMG, RPK-74.....                           | 6            | Flamethrower, LPO/RPO.....           | 1            |
| 7.62-mm Sniper Rifle, SVD.....                     | 1            | Night-Vision Goggles.....            | 4            |
| 7.62-mm GP MG, PKM.....                            | 3            | Night-Vision Sight (Small Arms)..... | 4            |
| 40-mm Under-Barrel Grenade Launcher,<br>BG-15..... | 7            | Night-Vision Sight (MG).....         | 3            |
|  |              | Radio, VHF, Manpack, Low-Power.....  | 5            |

*NOTE:* An infantry platoon in a motorized infantry battalion does not have organic transportation assets. Rather, it relies on the brigade-level troop transport company (p. 3-39) to provide trucks for troop movement. Movement of an infantry platoon requires two medium trucks.

Infantry Squad, Inf Plt

---

|                           |
|---------------------------|
| <b>INFANTRY<br/>SQUAD</b> |
|---------------------------|

Squad Leader..... AK-74  
 Machinegunner (x2)..... RPK-74  
 Rifleman (x5) ..... AK-74  
 Grenadier.....RPG-7V/PM

**PRINCIPAL ITEMS OF EQUIPMENT**

| <u>Equipment</u>                                   | <u>Total</u> | <u>Equipment</u>                      | <u>Total</u> |
|--|--------------|---------------------------------------|--------------|
| 9-mm Pistol, PM.....                               | 1            | ATGL, RPG-7V .....                    | 1            |
| 5.45-mm Assault Rifle, AK-74.....                  | 6            | ATRL, RPG-18/22.....                  | 2            |
| 5.45-mm LMG, RPK-74.....                           | 2            | Night-Vision Goggles .....            | 1            |
| 40-mm Under-Barrel Grenade Launcher,<br>BG-15..... | 2            | Night-Vision Sight (Small Arms) ..... | 1            |
|  |              | Radio, VHF, Manpack, Low-Power .....  | 1            |

**NOTES:**

1. An infantry squad in a motorized infantry battalion does not have organic transportation assets. Rather, it relies on the brigade-level troop transport company (p. 3-39) to provide a truck for troop movement. One medium truck can carry two infantry squads or one infantry squad and a weapons squad.
2. One squad per platoon has a 7.62-mm sniper rifle, SVD.
3. One squad per platoon has a flamethrower, LPO/RPO.

Weapons Squad, Inf Plt or Abn Inf Plt \_\_\_\_\_

|                                 |
|---------------------------------|
| <p><b>WEAPONS<br/>SQUAD</b></p> |
|---------------------------------|

Squad Leader..... AK-74  
 Machinegunner (x3)..... PKM/PM  
 Asst Machinegunner (x3)..... AK-74  
 Grenadier..... RPG-7V/PM

**PRINCIPAL ITEMS OF EQUIPMENT**

| <u>Equipment</u>                                   | <u>Total</u> | <u>Equipment</u>                     | <u>Total</u> |
|--|--------------|--------------------------------------|--------------|
| 9-mm Pistol, PM.....                               | 5            | ATGL, RPG-7V .....                   | 2            |
| 5.45-mm Assault Rifle, AK-74.....                  | 4            | Night-Vision Goggles .....           | 1            |
| 7.62-mm GP MG, PKM.....                            | 3            | Night-Vision Sight (Small Arms)..... | 1            |
| 40-mm Under-Barrel Grenade Launcher,<br>BG-15..... | 1            | Night-Vision Sight (MG).....         | 3            |
|  |              | Radio, VHF, Manpack, Low-Power ..... | 1            |

*NOTE:* The weapons squad does not have organic transportation assets. In a motorized infantry unit, it relies on the brigade-level troop transport company (p. 3-39) to provide a truck for troop movement. One medium truck can carry a weapons squad and an infantry squad.

Mortar Platoon, Inf Co and Commando Co \_\_\_\_\_

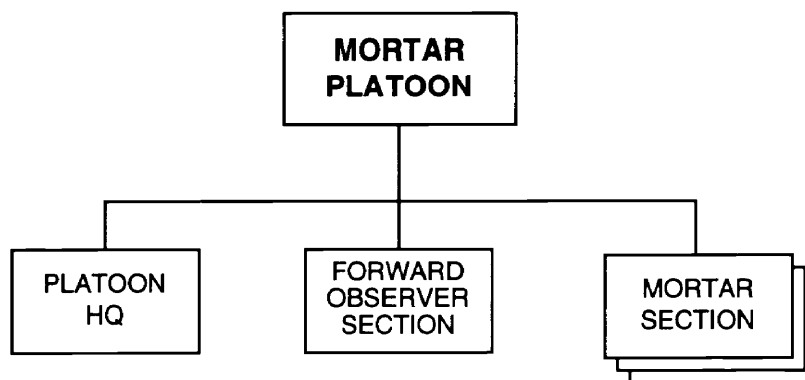

Platoon Leader ..... AK-74  
 Assistant Plt Leader..... BG-15, AK-74  
 Mortar Gunner (x6) ..... AK-74  
 Forward Observer..... RPG, BG-15, AK-74  
 Mortar Section Leader (x3) ..... RPG, AK-74

**PRINCIPAL ITEMS OF EQUIPMENT**

| <u>Equipment</u>                                   | <u>Total</u> | <u>Equipment</u>                     | <u>Total</u> |
|--|--------------|--------------------------------------|--------------|
| 60-mm Mortar, Light .....                          | 3            | ATRL, RPG-18/22.....                 | 6            |
| 5.45-mm Assault Rifle, AK-74.....                  | 12           | Night-Vision Goggles .....           | 4            |
| 40-mm Under-Barrel Grenade Launcher,<br>BG-15..... | 2            | Night-Vision Sight (Small Arms)..... | 3            |
|  |              | Radio, VHF, Portable, Low-Power..... | 5            |

**Weapons Company, Mtzd Inf Bn  
and Inf Bn**

---

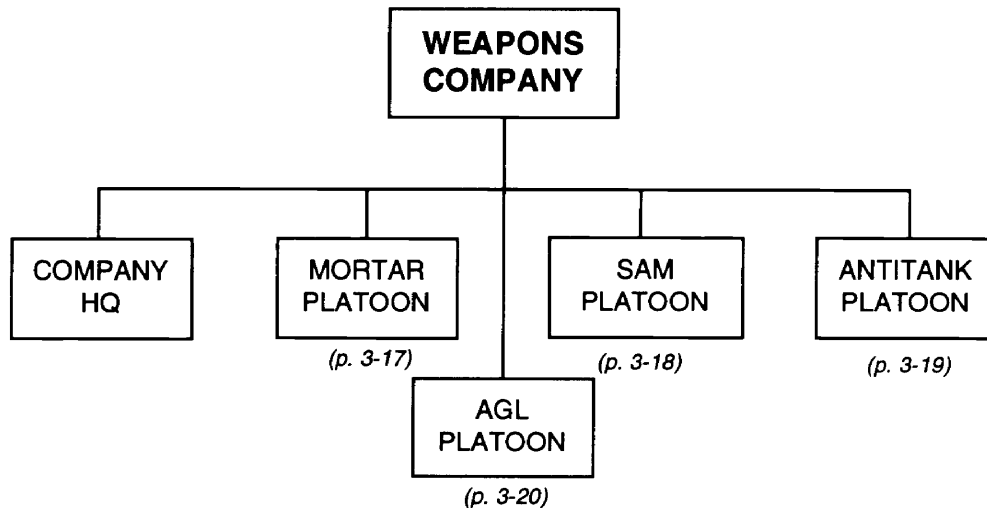

**PRINCIPAL ITEMS OF EQUIPMENT**

| <u>Equipment</u>                                    | <u>Total</u> | <u>Equipment</u>  | <u>Total</u> |
|---|--------------|---|--------------|
| 82-mm Mortar, M1937 .....                           | 3            | ATRL, RPG-18/22 .....                                   | 2            |
| SAM, Shoulder Fired .....                           | 9            | Rangefinder, Stereoscopic, DS-1 or<br>DM-09/DAK-1 ..... | 1            |
| ATGM, Manpack, AT-7/SAXHORN .....                   | 3            | Periscopic Aiming Circle, PAB2A .....                   | 1            |
| 73-mm Recoilless Gun, SPG-9 .....                   | 2            | Collimator .....  | 3            |
| 9-mm Pistol, PM .....                               | 20           | Night-Vision Sight (AGL) .....                          | 6            |
| 5.45-mm Assault Rifle, AK-74 .....                  | 66           | Night-Vision Sight (Small Arms) .....                   | 12           |
| 40-mm Under-Barrel Grenade Launcher,<br>BG-15 ..... | 4            | Radios:   |              |
| 30-mm Automatic Grenade Launcher,<br>AGS-17 .....   | 6            | VHF, Manpack, Low-Power .....                           | 13           |
| ATGL, RPG-7V .....                                  | 3            | VHF, Portable, Very-Low-Power .....                     | 4            |

**NOTES:**

1. The motorized infantry battalion does not have organic transportation assets to move its weapons company. Rather, it relies on the brigade-level weapons transport company (p. 3-40) to provide trucks for movement over longer distances. Movement of the weapons company requires 3 utility trucks and 12 light trucks.
2. Some motorized infantry or infantry battalions may have a mortar battery with nine 82-mm mortars (p. 3-24) instead of a mortar platoon in the weapons company.



**Mortar Platoon, Wpns Co, Mtzd Inf Bn  
and Inf Bn**

---

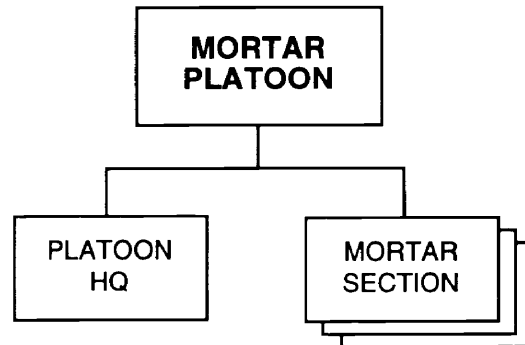

**PRINCIPAL ITEMS OF EQUIPMENT**

| <u>Equipment</u>                     | <u>Total</u> | <u>Equipment</u>                      | <u>Total</u> |
|--------------------------------------|--------------|---------------------------------------|--------------|
| 82-mm Mortar, M1937 .....            | 3            | Rangefinder, Stereoscopic, DS-1 or    |              |
| 9-mm Pistol, PM .....                | 4            | DM-09/DAK-1 .....                     | 1            |
| 5.45-mm Assault Rifle, AK-74 .....   | 18           | Periscopic Aiming Circle, PAB2A ..... | 1            |
| 40-mm Under-Barrel Grenade Launcher, |              | Collimator .....                      | 3            |
| BG-15 .....                          | 4            | Night-Vision Sight (Small Arms) ..... | 4            |
| ATRL, RPG-18/22 .....                | 3            | Radio, VHF, Manpack, Low-Power .....  | 4            |

**NOTES:**

1. In a motorized infantry battalion, one utility truck and three light trucks from the brigade-level weapons transport company (p. 3-40) can move this mortar platoon.
2. Some motorized infantry or infantry battalions may have a mortar battery with nine 82-mm mortars (p. 3-24) instead of this mortar platoon in the weapons company.

**SAM Platoon, Wpns Co, Mtzd Inf Bn  
and Inf Bn**

---

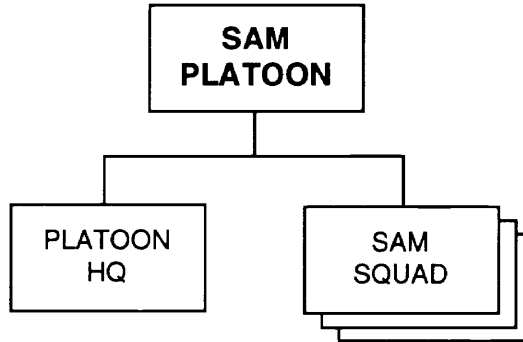

**PRINCIPAL ITEMS OF EQUIPMENT**

| <u>Equipment</u>         | <u>Total</u> | <u>Equipment</u>                          | <u>Total</u> |
|--------------------------|--------------|---|--------------|
| SAM, Shoulder-Fired..... | 9            | 5.45-mm Assault Rifle, AK-74.....         | 9            |
| 9-mm Pistol, PM.....     | 2            | Radio, VHF, Portable, Very-Low-Power..... | 4            |

*NOTE:* In a motorized infantry battalion, three lights trucks from the brigade-level weapons transport company (p. 3-40) can move this SAM platoon.

Antitank Platoon, Wpns Co,  
Mtzd Inf Bn and Inf Bn

---

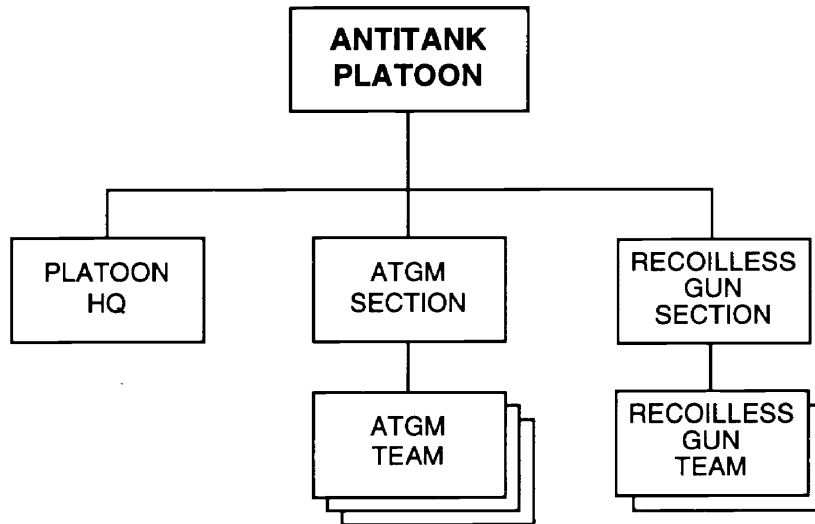

**PRINCIPAL ITEMS OF EQUIPMENT**

| <u>Equipment</u>                                   | <u>Total</u> | <u>Equipment</u>                     | <u>Total</u> |
|--|--------------|--------------------------------------|--------------|
| ATGM, Manpack, AT-7/SAXHORN.....                   | 3            | ATRL, RPG-18/22.....                 | 2            |
| 73-mm Recoilless Gun, SPG-9.....                   | 2            | Night-Vision Sight (Small Arms)..... | 5            |
| 9-mm Pistol, PM.....                               | 4            | Radio, VHF, Manpack, Low-Power ..... | 4            |
| 5.45-mm Assault Rifle, AK-74.....                  | 15           |                                      |              |
| 40-mm Under-Barrel Grenade Launcher,<br>BG-15..... | 4            |                                      |              |

NOTE: In a motorized infantry battalion, two light trucks from the brigade-level weapons transport company (p. 3-40) can carry this antitank platoon.

**Automatic Grenade Launcher Platoon,  
Wpns Co, Mtzd Inf Bn and Inf Bn**

---

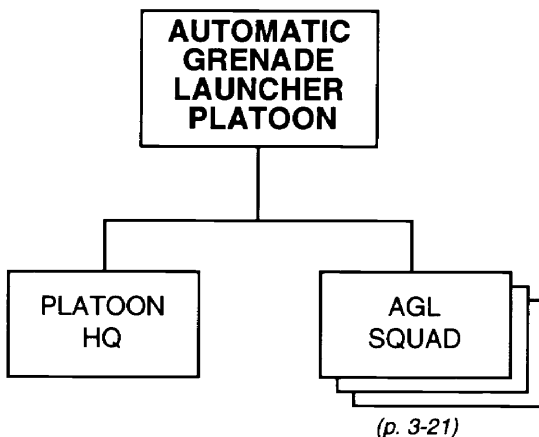

**PRINCIPAL ITEMS OF EQUIPMENT**

| <u>Equipment</u>                                  | <u>Total</u> | <u>Equipment</u>                     | <u>Total</u> |
|---|--------------|--------------------------------------|--------------|
| 30-mm Automatic Grenade Launcher,<br>AGS-17 ..... | 6            | 5.45-mm Assault Rifle, AK-74.....    | 18           |
| 9-mm Pistol, PM.....                              | 7            | Night-Vision Sight (AGL) .....       | 6            |
| ATRL, RPG-18/22.....                              | 3            | Night-Vision Sight (Small Arms)..... | 3            |
|   |              | Radio, VHF, Portable, Low-Power..... | 4            |

**NOTES:**

1. In a motorized infantry battalion, three light trucks from the brigade-level weapons transport company (p. 3-40) can carry this AGL platoon.
2. Depending on the situation, the motorized infantry battalion commander may retain the entire AGL platoon under his own control, or he may allocate its squads to individual infantry companies.

**Automatic Grenade Launcher Squad, AGL Pit, Wpns Co,  
Mtzd Inf Bn and Inf Bn**



Squad Leader .....AK-74  
 Senior Rifleman .....AK-74, RPG-18/22  
 Grenadier (x2) ..... AGS-17, PM  
 Rifleman/Asst Grenadier (x4).....AK-74

**PRINCIPAL ITEMS OF EQUIPMENT**

| <u>Equipment</u>                                  | <u>Total</u> | <u>Equipment</u>                     | <u>Total</u> |
|---|--------------|--------------------------------------|--------------|
| 30-mm Automatic Grenade Launcher,<br>AGS-17 ..... | 2            | ATRL, RPG-18/22.....                 | 1            |
| 9-mm Pistol, PM.....                              | 2            | Night-Vision Sight (AGL) .....       | 2            |
| 5.45-mm Assault Rifle, AK-74.....                 | 6            | Night-Vision Sight (Small Arms)..... | 1            |
|   |              | Radio, VHF, Portable, Low-Power..... | 1            |

**Signal Platoon, Mtzd Inf Bn and Mech Inf Bn**

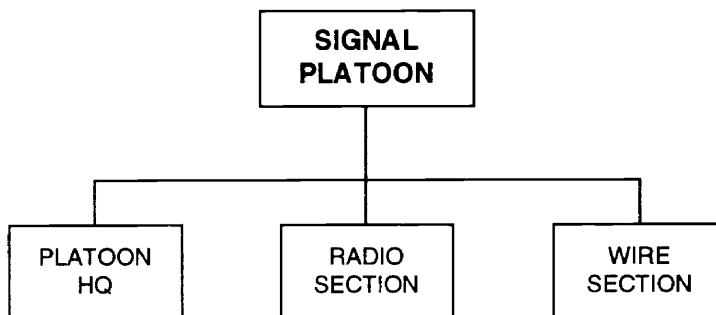

**PRINCIPAL ITEMS OF EQUIPMENT**

| <u>Equipment</u>                     | <u>Total</u> | <u>Equipment</u>                             | <u>Total</u> |
|--------------------------------------|--------------|--|--------------|
| ACV, BTR (R-145BM)* .....            | 1            | Radios:                                      |              |
| 9-mm Pistol, PM.....                 | 1            | VHF, Manpack, Low-Power.....                 | 3            |
| 5.45-mm Assault Rifle, AK-74.....    | 13           | VHF, Vehicle Mount,<br>Medium-Power .....    | 2            |
| Truck, Utility .....                 | 1            | HF, Vehicle Mount,<br>Medium-Power .....     | 1            |
| Truck, Light .....                   | 1            | HF/VHF, Vehicle Mount,<br>Medium-Power ..... | 1            |
| Van, Signal.....                     | 1            |  |              |
| Night-Vision Goggles (Driver).....   | 3            |  |              |
| Night-Vision Sight (Small Arms)..... | 2            |  |              |

**FOOTNOTE:** \* Some IFV-equipped mechanized infantry battalions may have an ACV, BMP-1KSh instead of the ACV, BTR (R-145BM).

Supply and Service Platoon, Mtzd Inf Bn \_\_\_\_\_

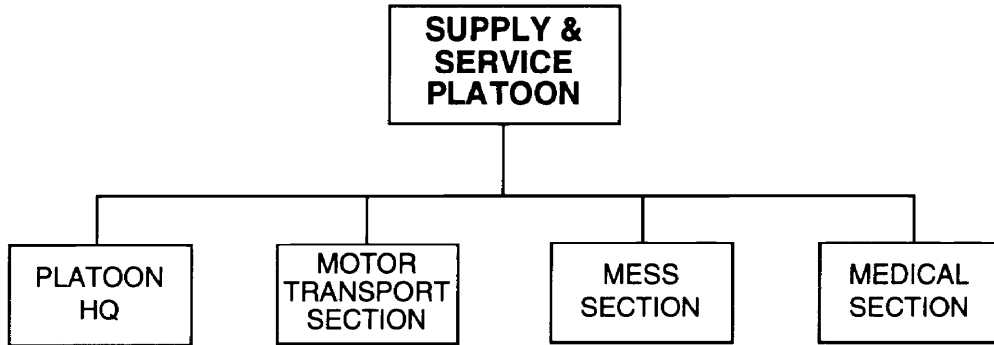

**PRINCIPAL ITEMS OF EQUIPMENT**

| <u>Equipment</u>                  | <u>Total</u> |
|-----------------------------------|--------------|
| 9-mm Pistol, PM.....              | 1            |
| 5.45-mm Assault Rifle, AK-74..... | 19           |
| ATRL, RPG-18/22.....              | 1            |
| Truck, Light .....                | 6            |
| Truck, Medium .....               | 2            |
| Van, Kitchen .....                | 1            |
| Ambulance .....                   | 1            |

| <u>Equipment</u>                          | <u>Total</u> |
|---|--------------|
| Trailer, Cargo, 2-Axle.....               | 1            |
| Trailer, Kitchen .....                    | 3            |
| Trailer, POL (4,200-Liter) .....          | 1            |
| Trailer, Water (900- or 1,200-liter)..... | 1            |
| Night-Vision Goggles (Driver) .....       | 2            |
| Night-Vision Sight (Small Arms).....      | 4            |
| Radio, VHF, Manpack, Low-Power .....      | 1            |

Mortar Battalion, Mtzd Inf Bde (Div)  
and Inf Bde (Div)

---

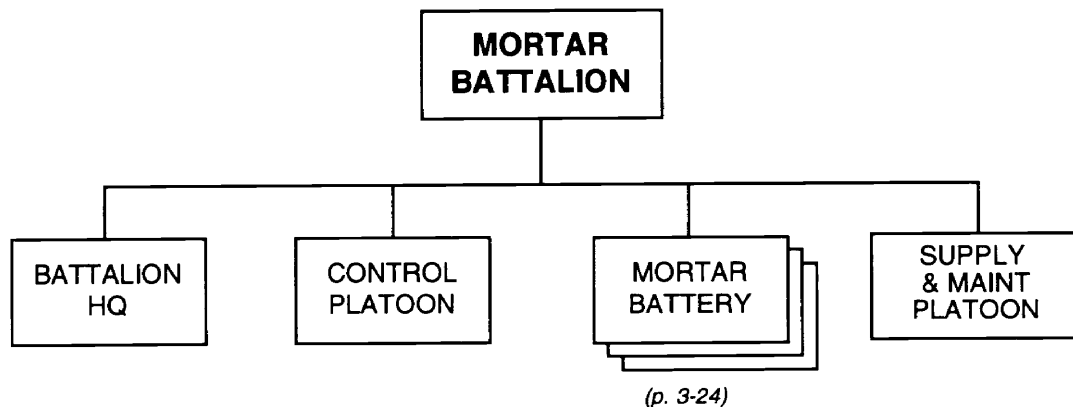

**PRINCIPAL ITEMS OF EQUIPMENT**

| <u>Equipment</u>  | <u>Total</u> |
|---|--------------|
| 120-mm Mortar, M1943/2S12 or<br>82-mm Mortar, M1937/2B9 ..... | 18           |
| 7.62-mm GP MG, PKM.....                                       | 6            |
| ATGL, RPG-7V.....   | 18           |
| Truck, Utility .....  | 3            |
| Truck, Light .....  | 23           |
| Truck, POL (5,000-Liter).....                                 | 1            |
| Van, Maintenance .....  | 1            |
| Van, Signal.....  | 1            |
| Ambulance .....   | 1            |
| Trailer, Cargo, 2-Axle.....                                   | 4            |
| Trailer, Generator.....                                       | 1            |
| Trailer, Kitchen.....   | 3            |
| Trailer, POL (1,200-Liter) .....                              | 1            |
| Trailer, Water (900-Liter) .....                              | 1            |

| <u>Equipment</u>   | <u>Total</u> |
|--|--------------|
| Rangefinder, Stereoscopic, DS-1 .....  | 3            |
| Periscopic Aiming Circle, PAB2A.....   | 3            |
| Collimator .....   | 18           |
| Radar, Battlefield Surveillance, Man-<br>Portable, PSNR-1 or TALL MIKE ..... | 1            |
| Radios:  |              |
| VHF, Manpack, Low-Power.....   | 18           |
| VHF, Portable, Low-Power or<br>Very-Low-Power .....                          | 2            |
| VHF, Vehicle Mount,<br>Medium-Power .....                                    | 3            |
| HF/VHF, Vehicle Mount,<br>Medium-Power .....                                 | 1            |
| Warning Receiver .....   | 1            |

Mortar Battery, Mortar Bn or Mech Inf Bn or Mtzd Inf Bde (Sep),  
 Inf Bde (Sep and Militia), and Mech Inf Bde (Sep) \_\_\_\_\_

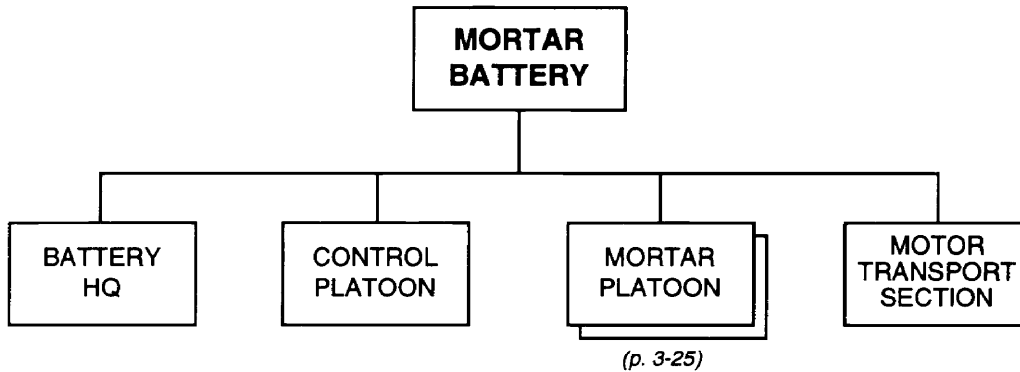

**PRINCIPAL ITEMS OF EQUIPMENT**

| <u>Equipment</u>  | <u>Total</u> | <u>Equipment</u>                          | <u>Total</u> |
|---|--------------|---|--------------|
| 120-mm Mortar, M1943/2S12 or<br>82-mm Mortar, M1937/2B9 ..... | 6            | Truck, Light .....                        | 7            |
| 9-mm Pistol, PM.....  | 14           | Rangefinder, Stereoscopic, DS-1 .....     | 1            |
| 5.45-mm Assault Rifle, AK-74.....                             | 47           | Periscopic Aiming Circle, PAB2A .....     | 1            |
| 7.62-mm GP MG, PKM.....                                       | 2            | Collimator .....                          | 6            |
| 40-mm Under-Barrel Grenade Launcher,<br>BG-15.....            | 6            | Night-Vision Goggles (Driver) .....       | 3            |
| ATGL, RPG-7V.....   | 6            | Night-Vision Sight (Small Arms) .....     | 6            |
| Truck, Utility .....  | 1            | Radios:                                   |              |
|   |              | VHF, Manpack, Low-Power .....             | 5            |
|   |              | VHF, Vehicle Mount,<br>Medium-Power ..... | 1            |

**NOTES:**

1. The infantry brigade (militia) is more likely to have 82-mm mortars and does not have the night-vision devices listed above.
2. Some motorized infantry or infantry battalions may have a mortar battery with nine 82-mm mortars instead of a mortar platoon in the weapons company. In that case the battery would have a third mortar platoon.



**Mortar Platoon, Mortar Btry, Mortar Bn or Mech Inf Bn or Mtzd Inf Bde (Sep),  
Inf Bde (Sep and Militia), and Mech Inf Bde (Sep)** \_\_\_\_\_

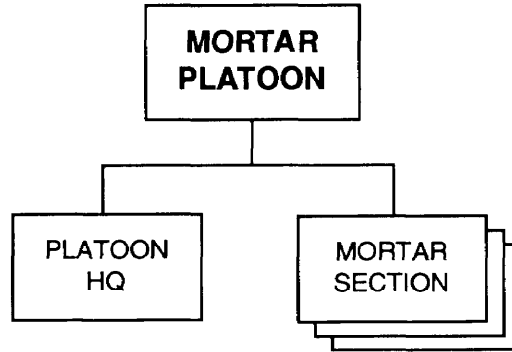

**PRINCIPAL ITEMS OF EQUIPMENT**

| <u>Equipment</u>                   | <u>Total</u> | <u>Equipment</u>                      | <u>Total</u> |
|------------------------------------|--------------|---------------------------------------|--------------|
| 120-mm Mortar, M1943/2S12          |              | ATGL, RPG-7V .....                    | 3            |
| or 82-mm Mortar, M1937/2B9 .....   | 3            | Night-Vision Sight (Small Arms) ..... | 4            |
| 9-mm Pistol, PM .....              | 4            | Collimator .....                      | 3            |
| 5.45-mm Assault Rifle, AK-74 ..... | 18           | Radio, VHF, Manpack, Low-Power .....  | 1            |

*NOTE:* Three light trucks from the mortar battery's motor transport section normally carry the three mortar sections and the platoon headquarters. However, the mortar crew can move the mortar over short distances when necessary.

Antiaircraft Gun Battery (23-mm), Mtzd Inf Bde (Sep and Div), Inf Bde (Sep, Div, and Militia), and Abn Inf Bde, or Arty Regt or Arty Bde or MRL Bde or SAM Bn (SA-4)

---

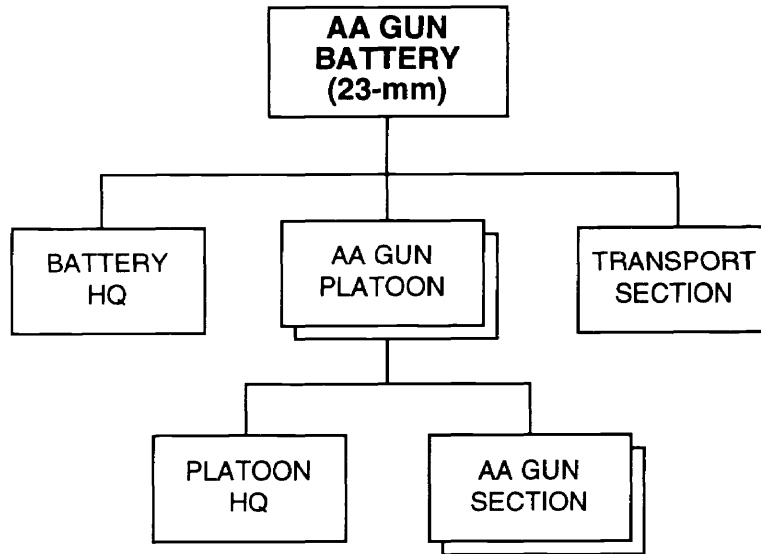

**PRINCIPAL ITEMS OF EQUIPMENT**

| <u>Equipment</u>         | <u>Total</u> | <u>Equipment</u>             | <u>Total</u> |
|--------------------------|--------------|------------------------------|--------------|
| 23-mm AA Gun, ZU-23..... | 8            | Radios:                      |              |
| Truck, Utility .....     | 1            | VHF, Manpack, Low-Power..... | 3            |
| Truck, Light .....       | 8            | Warning Receiver .....       | 1            |

*NOTE:* In motorized infantry brigades, this battery may have a mix of antiaircraft weapons. When it does, the mix is four ZU-23 and four ZSU-23-4.

**ATGM Battery, Mtd Inf Bde (Sep), Inf Bde (Sep), and Mech Inf Bde (Sep and Div),  
or Mtd Inf Div, Inf Div, and Mech Inf Div**

---

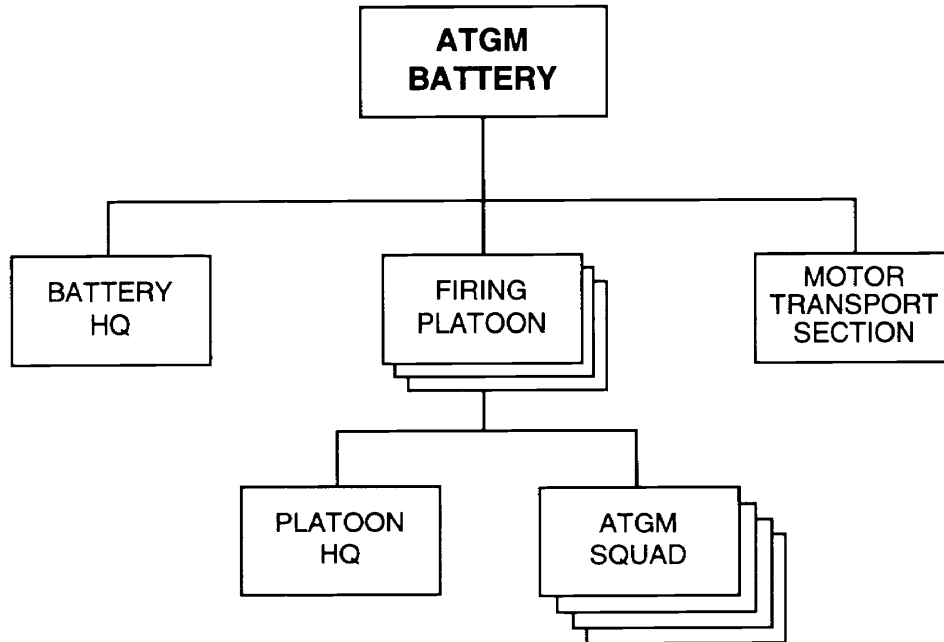

**PRINCIPAL ITEMS OF EQUIPMENT**

| <u>Equipment</u>  | <u>Total</u> |
|---|--------------|
| ATGM Vehicle, 9P133 w/AT-3/SAGGER<br>or 9P148 w/AT-5/SPANDREL ..... | 12           |
| ATGL, RPG-7V .....  | 12           |
| ACV, BRDM-2U .....  | 4            |
| Truck, Medium .....   | 3            |
| Rangefinder, Stereoscopic, DS-1 .....                               | 1            |

| <u>Equipment</u>   | <u>Total</u> |
|--|--------------|
| Radar, Battlefield Surveillance, Man-<br>Portable, PSNR-1 or TALL MIKE ..... | 1            |
| Radios:  |              |
| VHF, Manpack, Low-Power .....  | 4            |
| VHF, Vehicle Mount,<br>Medium-Power .....                                    | 16           |

ATGM Platoon, Mtzd Inf Bde (Div)  
and Inf Bde (Div)

---

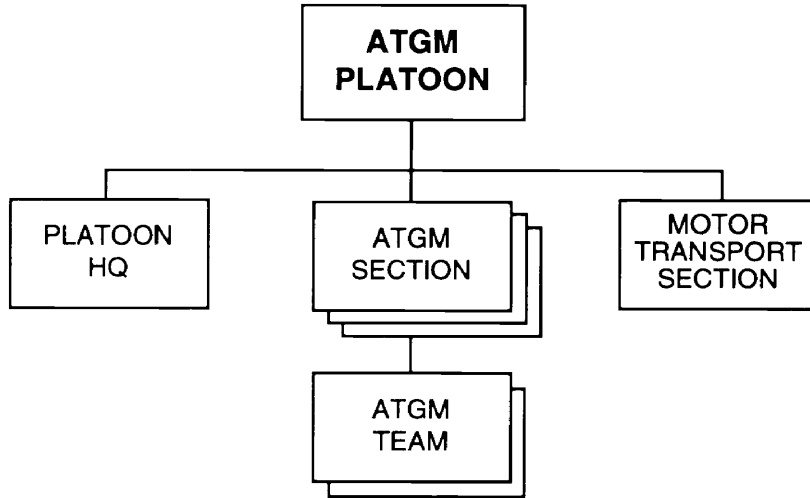

**PRINCIPAL ITEMS OF EQUIPMENT**

| <u>Equipment</u>                 | <u>Total</u> |
|----------------------------------|--------------|
| ATGM, Manpack, AT-4/SPIGOT ..... | 6            |
| ATRL, RPG-18/22 .....            | 6            |
| Truck, Light .....               | 3            |

| <u>Equipment</u>               | <u>Total</u> |
|--------------------------------|--------------|
| Radios:                        |              |
| VHF, Manpack, Low-Power .....  | 3            |
| VHF, Portable, Low-Power ..... | 4            |

**Reconnaissance Platoon, Mtzd Inf Bde (Div)  
and Inf Bde (Div and Militia)**

---

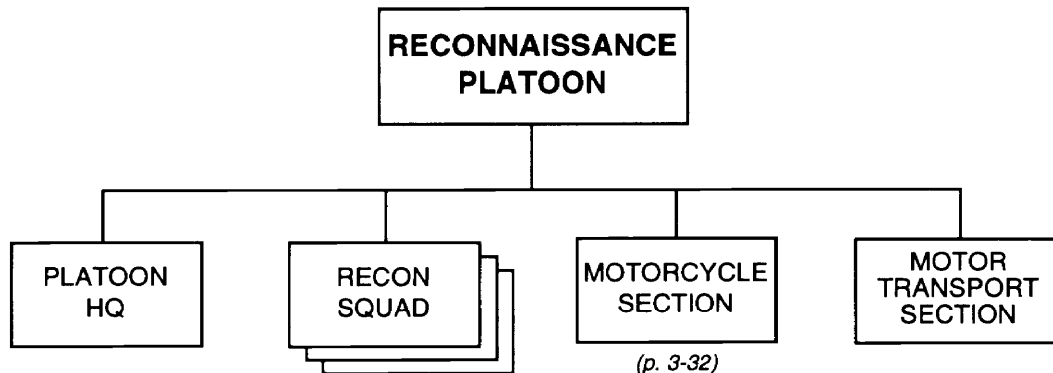

**PRINCIPAL ITEMS OF EQUIPMENT**

| <u>Equipment</u>                                   | <u>Total</u> | <u>Equipment</u>   | <u>Total</u> |
|--|--------------|--|--------------|
| 9-mm Pistol, PM.....                               | 1            | Night-Vision Goggles .....   | 5            |
| 5.45-mm Assault Rifle, AK-74.....                  | 28           | Night-Vision Goggles (Drivers) .....   | 1            |
| 5.45-mm LMG, RPK-74.....                           | 3            | Night-Vision Sight (Small Arms).....   | 4            |
| 40-mm Under-Barrel Grenade Launcher,<br>BG-15..... | 4            | Radar, Battlefield Surveillance, Man-<br>Portable, PSNR-1 or TALL MIKE ..... | 1            |
| ATRL, RPG-18/22.....                               | 3            | Radios:  |              |
| Motorcycle .....                                   | 3            | VHF, Manpack, Low-Power.....   | 3            |
| Truck, Medium .....                                | 1            | VHF, Portable, Low-Power .....   | 1            |

*NOTE:* In some cases, the medium truck in the motor transport section may carry a 12.7-mm HMG or a 30-mm automatic grenade launcher. This weapon provides a minimum of fire support for the unit during movement by vehicle.

**Reconnaissance Company, Mtzd Inf Bde (Sep) and Inf Bde (Sep),  
or Mtzd Inf Div and Inf Div, or MD**

---

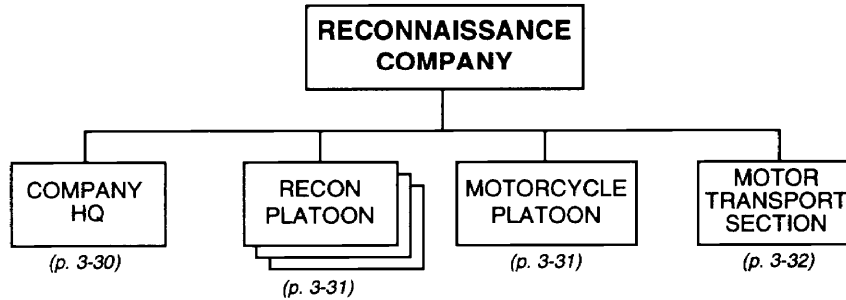

**PRINCIPAL ITEMS OF EQUIPMENT**

| <u>Equipment</u>                                   | <u>Total</u> | <u>Equipment</u>  | <u>Total</u> |
|--|--------------|---|--------------|
| 9-mm Pistol, PM.....                               | 6            | Night-Vision Sight (Small Arms).....  | 13           |
| 5.45-mm Assault Rifle, AK-74.....                  | 87           | Radar, Battlefield Surveillance, Man-<br>Portable, PSNR-1 or TALL MIKE..... | 3            |
| 5.45-mm LMG, RPK-74.....                           | 10           | Radios:   |              |
| 40-mm Under-Barrel Grenade Launcher,<br>BG-15..... | 17           | VHF, Manpack, Low-Power.....  | 11           |
| ATRL, RPG-18/22.....                               | 10           | VHF, Portable, Low-Power.....   | 4            |
| Truck, Utility.....                                | 1            | VHF, Vehicle Mount,<br>Medium-Power.....                                    | 1            |
| Truck, Medium.....                                 | 3            | HF, Vehicle Mount,<br>Medium-Power.....                                     | 1            |
| Motorcycle.....                                    | 9            | Warning Receiver.....   | 1            |
| Night-Vision Goggles.....                          | 17           |   |              |
| Night-Vision Goggles (Driver).....                 | 4            |   |              |

**Company Headquarters, Recon Co, Mtzd Inf Bde (Sep) and Inf Bde (Sep),  
or Mtzd Inf Div and Inf Div, or MD**

---



**PRINCIPAL ITEMS OF EQUIPMENT**

| <u>Equipment</u>                                   | <u>Total</u> | <u>Equipment</u>                     | <u>Total</u> |
|--|--------------|--------------------------------------|--------------|
| 9-mm Pistol, PM.....                               | 2            | ATRL, RPG-18/22.....                 | 1            |
| 5.45-mm Assault Rifle, AK-74.....                  | 4            | Night-Vision Goggles.....            | 1            |
| 5.45-mm LMG, RPK-74.....                           | 1            | Night-Vision Sight (Small Arms)..... | 1            |
| 40-mm Under-Barrel Grenade Launcher,<br>BG-15..... | 1            | Radio, VHF, Manpack, Low-Power.....  | 1            |

*NOTE:* The reconnaissance company's motor transport section has a utility truck available to transport the company headquarters. This truck carries additional radios.

**Reconnaissance Platoon, Recon Co, Mtzd Inf Bde (Sep) and Inf Bde (Sep),  
or Mtzd Inf Div and Inf Div, or MD**

---

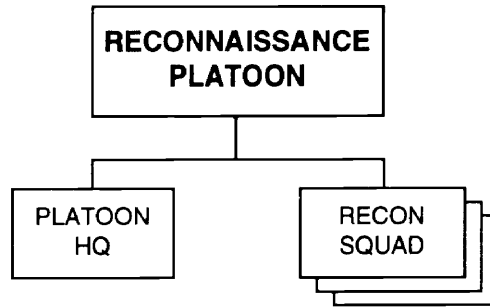

**PRINCIPAL ITEMS OF EQUIPMENT**

| <u>Equipment</u>                                   | <u>Total</u> | <u>Equipment</u>   | <u>Total</u> |
|--|--------------|--|--------------|
| 9-mm Pistol, PM.....                               | 1            | Night-Vision Goggles .....   | 4            |
| 5.45-mm Assault Rifle, AK-74.....                  | 19           | Night-Vision Sight (Small Arms).....   | 4            |
| 5.45-mm LMG, RPK-74.....                           | 3            | Radar, Battlefield Surveillance, Man-<br>Portable, PSNR-1 or TALL MIKE ..... | 1            |
| 40-mm Under-Barrel Grenade<br>Launcher, BG-15..... | 4            | Radio, VHF, Manpack, Low-Power .....   | 3            |
| ATRL, RPG-18/22.....                               | 3            |  |              |

**Motorcycle Platoon, Recon Co, Mtzd Inf Bde (Sep), Mech Inf Bde (APC) (Sep) and  
Inf Bde (Sep), or Mtzd Inf Div and Inf Div, or MD**

---

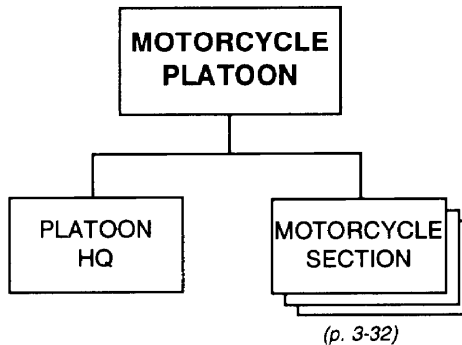

**PRINCIPAL ITEMS OF EQUIPMENT**

| <u>Equipment</u>                  | <u>Total</u> | <u>Equipment</u>                                   | <u>Total</u> |
|-----------------------------------|--------------|--|--------------|
| Motorcycle .....                  | 9            | 40-mm Under-Barrel Grenade Launcher,<br>BG-15..... | 4            |
| 9-mm Pistol, PM.....              | 1            | Night-Vision Goggles .....                         | 4            |
| 5.45-mm Assault Rifle, AK-74..... | 17           | Radio, VHF, Portable, Low-Power.....               | 4            |

**Motorcycle Section, Motorcycle Pit, Recon Co, or Recon Plt, Mtzd Inf Bde (Div) and Inf Bde (Div and Militia), or Recon Co, Mech Inf Bde (IFV) (Sep) and Tank Bale, or Signal Plt, Commando Bn** \_\_\_\_\_

|                               |
|-------------------------------|
| <b>MOTORCYCLE<br/>SECTION</b> |
|-------------------------------|

**PRINCIPAL ITEMS OF EQUIPMENT**

| <u>Equipment</u>                                   | <u>Total</u> | <u>Equipment</u>                     | <u>Total</u> |
|--|--------------|--------------------------------------|--------------|
| Motorcycle .....                                   | 3            | Night-Vision Goggles .....           | 1            |
| 5.45-mm Assault Rifle, AK-74.....                  | 6            | Radio, VHF, Portable, Low-Power..... | 1            |
| 40-mm Under-Barrel Grenade Launcher,<br>BG-15..... | 1            |                                      |              |

**Motor Transport Section, Recon Co, Mtzd Inf Div and Inf Div, or MD or Mtzd Inf Bde (Sep) and Inf Bde (Sep and Militia)** \_\_\_\_\_

|  |
|--|
| <b>MOTOR<br/>TRANSPORT<br/>SECTION</b> |
|--|

**PRINCIPAL ITEMS OF EQUIPMENT**

| <u>Equipment</u>                    | <u>Total</u> | <u>Equipment</u>                          | <u>Total</u> |
|-------------------------------------|--------------|---|--------------|
| 5.45-mm Assault Rifle, AK-74.....   | 9            | Radios:                                   |              |
| Truck, Utility .....                | 1            | VHF, Manpack, Low-Power.....              | 1            |
| Truck, Medium .....                 | 3            | VHF, Vehicle Mount,<br>Medium-Power ..... | 1            |
| Night-Vision Goggles (Driver) ..... | 4            | HF, Vehicle Mount,<br>Medium-Power .....  | 1            |
|                                     |              | Warning Receiver .....                    | 1            |

*NOTE:* In some cases, the medium trucks in this motor transport section may carry a 12.7-mm HMG or a 30-mm automatic grenade launcher. These weapons provide a minimum of fire support for the reconnaissance company during movement by vehicle.



Engineer Company, Mtzd Inf Bde (Sep and Div) and Inf Bde (Sep and Div),  
 or Mtzd Inf Div and Inf Div, or MD or MR \_\_\_\_\_

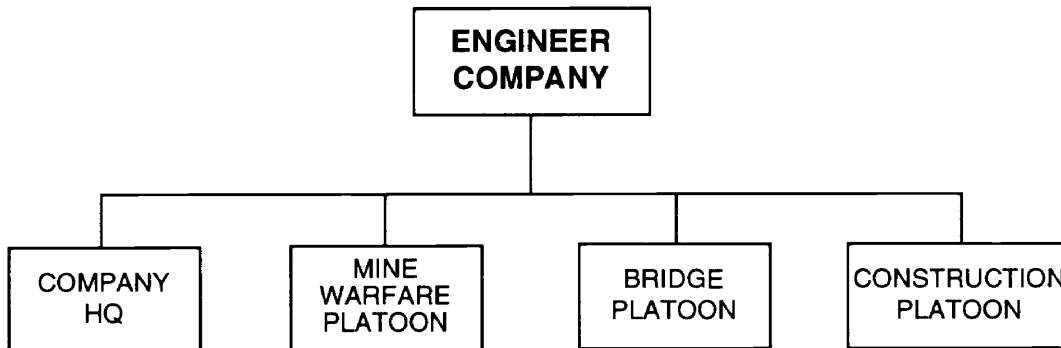

**PRINCIPAL ITEMS OF EQUIPMENT**

| <u>Equipment</u>                | <u>Total</u> | <u>Equipment</u>                     | <u>Total</u> |
|---------------------------------|--------------|--------------------------------------|--------------|
| ATRL, RPG-18/22.....            | 4            | Bridge, Truck-Launched.....          | 4            |
| Flamethrower, LPO/RPO.....      | 4            | Ditching Machine, PZM/TMK.....       | 4**          |
| Truck, Utility.....             | 4            | Route-Clearing Vehicle, BAT/PKT..... | 1**          |
| Truck, Medium.....              | 9            | Minelayer, PMR.....                  | 3            |
| Truck, Crane.....               | 2            | Mine Detector, DIM.....              | 1            |
| Truck, Dump.....                | 2            | Radios:                              |              |
| Truck, Water Purification.....  | 1            | VHF, Vehicle Mount,                  |              |
| Van, Maintenance.....           | 1            | Medium-Power.....                    | 1            |
| Van, Signal.....                | 1            | HF or VHF, Manpack,                  |              |
| Trailer, Cargo, 1-Axle.....     | 6*           | Low-Power.....                       | 4            |
| Trailer, Cargo, 2-Axle.....     | 2            | HF, Vehicle Mount,                   |              |
| Trailer, Kitchen.....           | 1            | Medium-Power.....                    | 1            |
| Trailer, Water (900-Liter)..... | 1            |                                      |              |

*NOTE:* The motorized infantry division or infantry division normally has only an engineer company organic to it. However, such a division would probably receive additional support from national-level engineer organizations.

**FOOTNOTES:**

\* An engineer company in a motorized infantry brigade or division normally does not have the six 1-axle cargo trailers shown here.

\*\* An engineer company in an infantry brigade normally does not have ditching machines or a route-clearing vehicle.

Signal Company, Mtzd Inf Bde (Sep and Div) and Inf Bde (Sep and Div),  
or Mtzd Inf Div and Inf Div, or MD

---

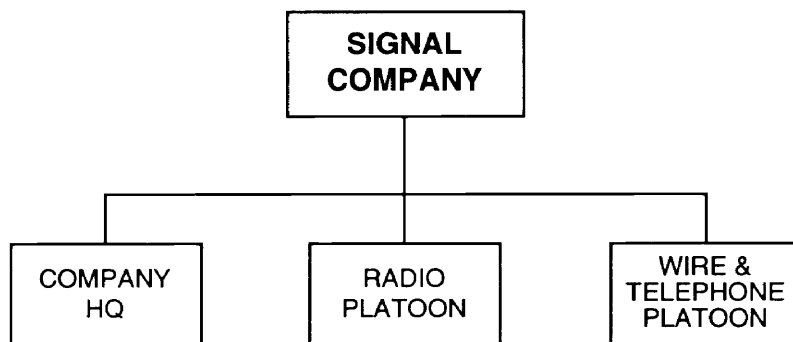

**PRINCIPAL ITEMS OF EQUIPMENT**

| <u>Equipment</u>             | <u>Total</u> | <u>Equipment</u>                   | <u>Total</u> |
|------------------------------|--------------|------------------------------------|--------------|
| Truck, Utility .....         | 5            | HF/VHF, Vehicle Mount,             |              |
| Truck, Light .....           | 3            | High-Power .....                   | 2            |
| Van, Signal.....             | 10           | HF, Manpack, Low-Power.....        | 2            |
| Motorcycle .....             | 3            | HF, Vehicle Mount, High-Power..... | 1            |
| Trailer, Generator.....      | 1            | HF, Vehicle Mount,                 |              |
| Radios:                      |              | Medium-Power .....                 | 2            |
| VHF, Manpack, Low-Power..... | 7            | Radio Relay, VHF/UHF.....          | 2            |
| HF/VHF, Vehicle Mount,       |              | Warning Receiver .....             | 3            |
| Medium-Power .....           | 8            |                                    |              |

**NOTES:**

1. The radios listed normally support the brigade headquarters, but the brigade may attach some to subordinate headquarters.
2. A motorized infantry division or infantry division with only a signal company organic to it would probably receive additional signal support from the national asset pool.
3. Motorcycles provide messenger/courier service.
4. Field telephones and switchboards are standard equipment in the wire and telephone platoon.

**Chemical Defense Platoon, Mtzd Inf Bde (Sep and Div), Mech Inf Bde (Sep and Div), and Tank Bde, or Arty Regt or SP Arty Regt or Arty Bde or Air Defense Regt or AA Gun Regt or MRL Bde or SAM Regt (SA-6 and SA-8) or SAM Bde (SA-2, SA-3, SA-4, and SA-11 ) or Engr Bde**\_\_\_\_\_

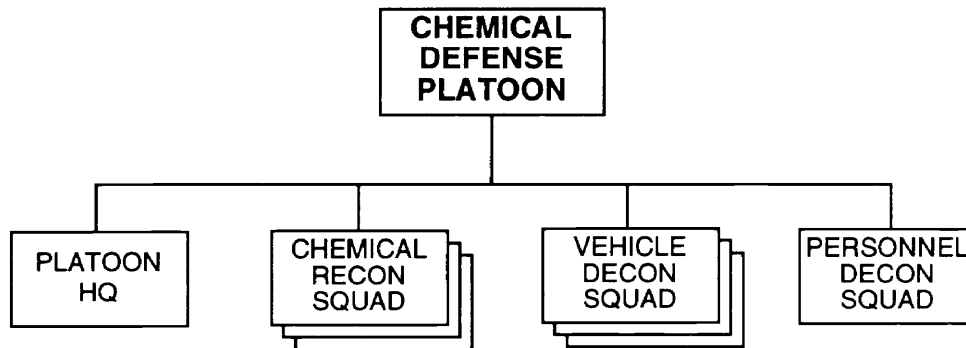

**PRINCIPAL ITEMS OF EQUIPMENT**

| <u>Equipment</u>                                    | <u>Total</u> | <u>Equipment</u>                   | <u>Total</u> |
|---|--------------|------------------------------------|--------------|
| Chemical Recon Vehicle, BRDM-2RKh<br>or RKhM* ..... | 3            | Trailer, Water (1,200-Liter) ..... | 2            |
| Truck, Decon, ARS-12U/14 .....                      | 3            | Radios:                            |              |
| Truck, Decon, DDA-53/66 .....                       | 1            | VHF, Vehicle Mount,                |              |
| Truck, Water (2,000-Liter) .....                    | 2            | Medium-Power .....                 | 3            |
|   |              | HF, Manpack, Low-Power .....       | 1            |

**FOOTNOTE:** \* The tracked RKhM is more common in mechanized infantry, tank, and SP artillery units. In other units, the wheeled BRDM-2RKh is more common, and even the truck-mounted UAZ-69RKh may appear.

**Materiel Support Company, Mtzd Inf Bde (Sep and Div)  
and Mech Inf Bde (Sep and Div)**

---

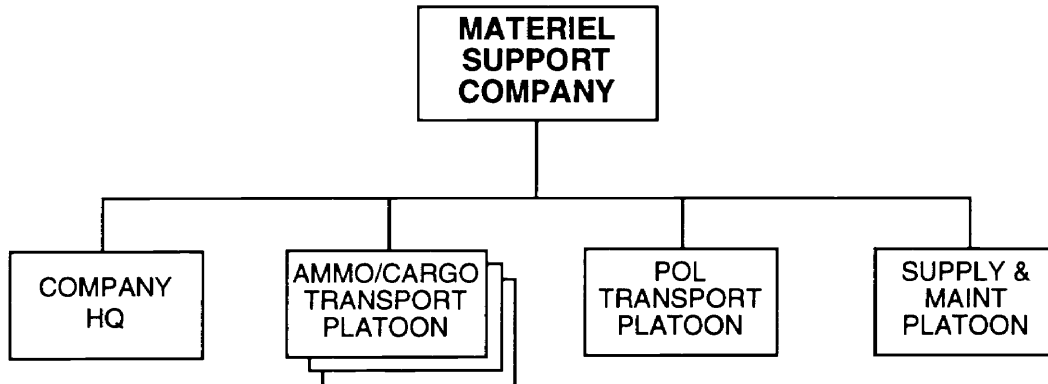

**PRINCIPAL ITEMS OF EQUIPMENT**

| <u>Equipment</u>                 | <u>Sep</u> | <u>Div</u> | <u>Equipment</u>                   | <u>Sep</u> | <u>Div</u> |
|----------------------------------|------------|------------|------------------------------------|------------|------------|
| Truck, Utility .....             | 2          | 2          | Trailer, Generator.....            | 1          | 1          |
| Truck, Light .....               | 4          | 4          | Trailer, Kitchen.....              | 2          | 2          |
| Truck, Medium .....              | 45         | 30         | Trailer, POL (4,200-Liter) .....   | 15         | 10         |
| Truck, POL (5,000-Liter).....    | 15         | 10         | Trailer, Water (1,200-Liter) ..... | 1          | 1          |
| Truck, Water (2,000-Liter) ..... | 4          | 3          | Radio, VHF, Manpack,               |            |            |
| Van, Maintenance .....           | 1          | 1          | Low-Power.....                     | 1          | 1          |
| Trailer, Cargo, 2-Axle.....      | 30         | 20         |                                    |            |            |

Maintenance Company, Mtzd Inf Bde  
(Sep and Div) or MD \_\_\_\_\_

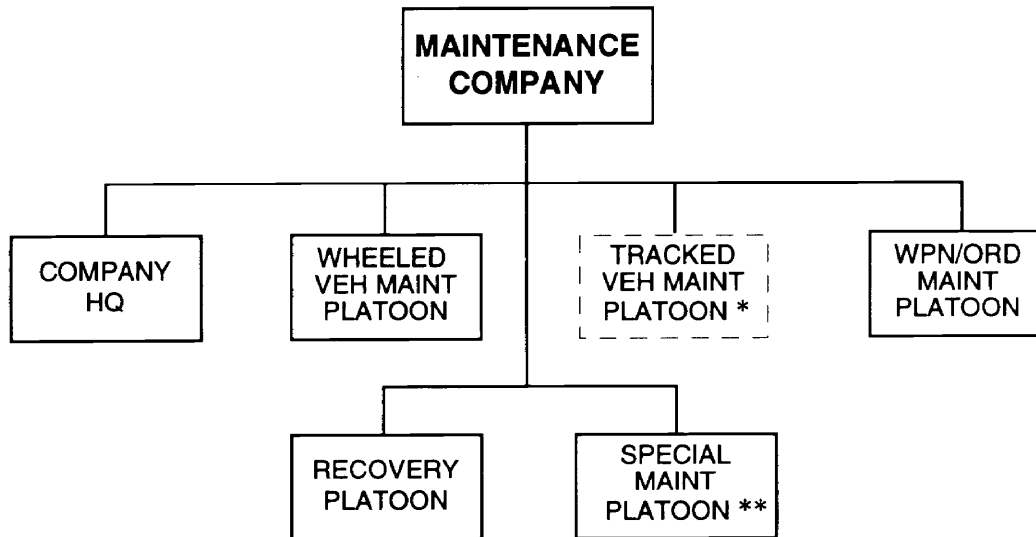

**PRINCIPAL ITEMS OF EQUIPMENT**

| <u>Equipment</u>       | <u>Total</u> | <u>Equipment</u>             | <u>Total</u> |
|------------------------|--------------|------------------------------|--------------|
| Van, Maintenance ..... | 9            | Trailer, Cargo, 2-Axle.....  | 4            |
| ATGL, RPG-7V.....      | 3            | Trailer, Generator.....      | 2            |
| Truck, Utility .....   | 1            | Radios:                      |              |
| Truck, Medium .....    | 2            | VHF, Manpack, Low-Power..... | 1            |
| Truck, Crane .....     | 1            | VHF, Vehicle Mount,          |              |
| Truck, Recovery.....   | 2            | Medium-Power .....           | 2            |

**FOOTNOTES:**

\* Motorized infantry brigades do not normally have a tracked vehicle maintenance platoon. The exception is when the motorized brigade has one mechanized battalion. Therefore, the equipment totals above do not include this platoon.

\*\* The special maintenance platoon consists of an arc and gas welding section, battery repair and recharging section, and electrical repair section.

**Motor Transport Battalion,  
Mtzd Inf Bde (Sep and Div)**

---

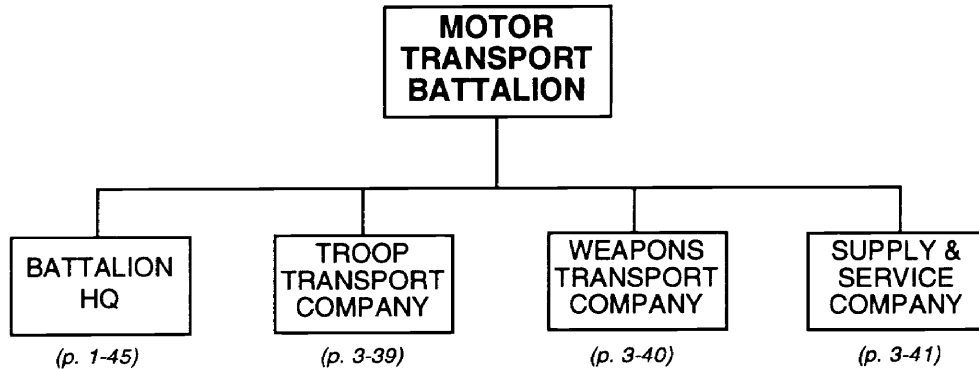

**PRINCIPAL ITEMS OF EQUIPMENT**

| <u>Equipment</u>               | <u>Total</u> |
|--------------------------------|--------------|
| ATRL, RPG-18/22.....           | 8            |
| Truck, Utility.....            | 14           |
| Truck, Light.....              | 39           |
| Truck, Medium.....             | 60           |
| Truck, Crane.....              | 1            |
| Truck, POL (5,000- Liter)..... | 4            |
| Van, Maintenance.....          | 1            |
| Van, Signal.....               | 1            |
| Ambulance.....                 | 1            |
| Trailer, Cargo, 1-Axle.....    | 2            |
| Trailer, Cargo, 2-Axle.....    | 4            |
| Trailer, Generator.....        | 6            |

| <u>Equipment</u>                            | <u>Total</u> |
|---|--------------|
| Trailer, Kitchen.....                       | 3            |
| Trailer, POL (4,200-Liter).....             | 4            |
| Trailer, Water (1,200-Liter).....           | 3            |
| Night-Vision Goggles (Driver).....          | 12           |
| Radios:                                     |              |
| VHF, Manpack, Low-Power.....                | 3            |
| VHF, Vehicle Mount,<br>Medium-Power.....    | 6            |
| HF, Manpack, Low-Power.....                 | 1            |
| HF/VHF, Vehicle Mount,<br>Medium Power..... | 1            |
| Warning Receiver.....                       | 1            |

**Troop Transport Company,  
Motor Transport Bn**

---

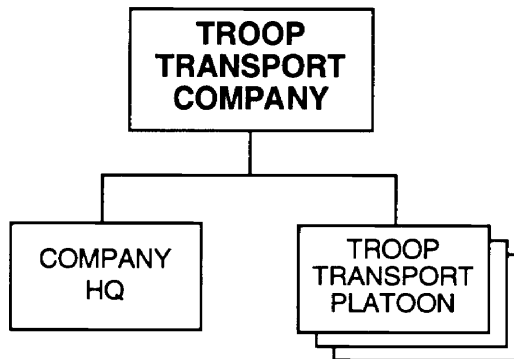

**PRINCIPAL ITEMS OF EQUIPMENT**

| <u>Equipment</u>                   | <u>Total</u> | <u>Equipment</u>             | <u>Total</u> |
|------------------------------------|--------------|------------------------------|--------------|
| ATRL, RPG-18/22.....               | 3            | Radios:                      |              |
| Truck, Utility .....               | 1            | VHF, Manpack, Low-Power..... | 1            |
| Truck, Medium .....                | 54           | VHF, Vehicle Mount,          |              |
| Night-Vision Goggles (Driver)..... | 4            | Medium Power.....            | 3            |

**NOTES:**

1. The infantry companies in a motorized infantry battalion do not have organic transportation assets. Rather, they rely on the brigade-level troop transport company to provide trucks for troop movement.
2. Each medium truck can carry up to two infantry squads or weapons squads. Thus, each 18-truck troop transport platoon is capable of transporting the squads of one motorized infantry battalion. The trucks also have room to carry platoon and company headquarters elements, as well as the company-level mortar platoon.
3. One or two medium trucks in each troop transport platoon may carry a 12.7-mm HMG or a 30-mm automatic grenade launcher. These weapons provide a minimum of fire support for the unit during movement by vehicle.
4. Similarly, the weapons company of a motorized infantry battalion receives transportation support from the brigade-level weapons transport company (p. 3-40). Other units subordinate to the motorized infantry battalion provide their own transportation.

**Weapons Transport Company,  
Motor Transport Bn**

---

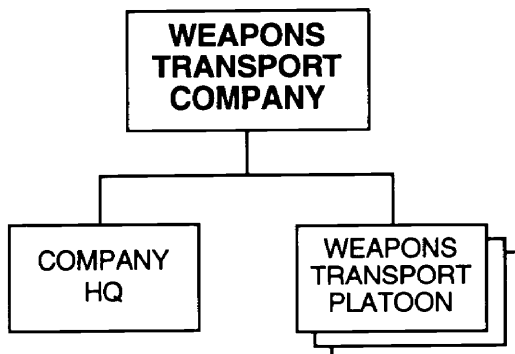

**PRINCIPAL ITEMS OF EQUIPMENT**

| <u>Equipment</u>                   | <u>Total</u> | <u>Equipment</u>             | <u>Total</u> |
|------------------------------------|--------------|------------------------------|--------------|
| ATRL, RPG-18/22.....               | 3            | Radios:                      |              |
| Truck, Utility .....               | 10           | VHF, Manpack, Low-Power..... | 1            |
| Truck, Light .....                 | 36           | VHF, Vehicle Mount,          |              |
| Night-Vision Goggles (Driver)..... | 4            | Medium Power.....            | 3            |

**NOTES:**

1. The weapons company of a motorized infantry battalion does not have organic transportation assets. Rather, it relies on the brigade-level weapons transport company to provide trucks for movement over longer distances.
2. A weapons transport platoon with 3 utility trucks and 12 light trucks can transport the weapons and crews of one weapons company.



**Supply and Service Company,  
Motor Transport Bn**

---

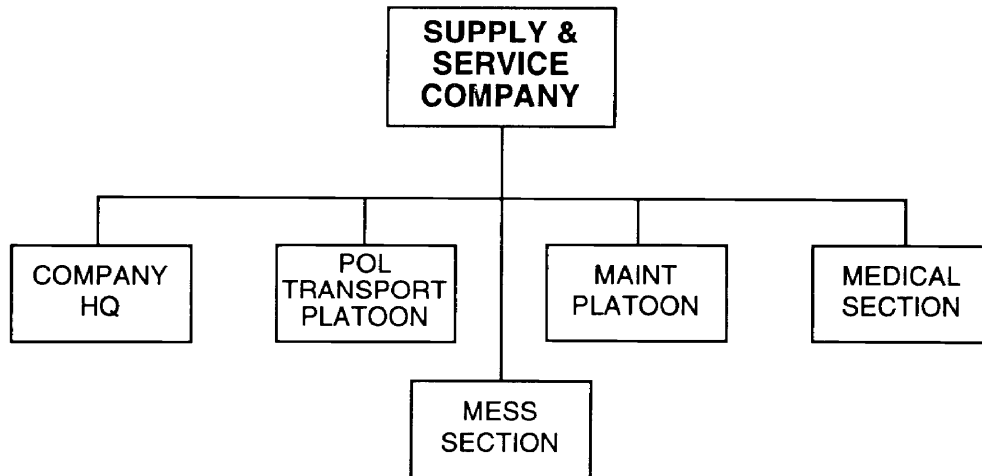

**PRINCIPAL ITEMS OF EQUIPMENT**

| <u>Equipment</u>               | <u>Total</u> | <u>Equipment</u>                     | <u>Total</u> |
|--------------------------------|--------------|--------------------------------------|--------------|
| ATRL, RPG-18/22 .....          | 2            | Trailer, Cargo, 1-Axle.....          | 2            |
| Truck, Utility .....           | 1            | Trailer, Cargo, 2-Axle.....          | 2            |
| Truck, Light .....             | 3            | Trailer, Generator.....              | 6            |
| Truck, Medium .....            | 6            | Trailer, Kitchen.....                | 3            |
| Truck, Crane .....             | 1            | Trailer, POL (4,200-Liter) .....     | 4            |
| Truck, POL (5,000- Liter)..... | 4            | Trailer, Water (1,200-Liter) .....   | 3            |
| Van, Maintenance .....         | 10           | Night-Vision Goggles (Driver) .....  | 4            |
| Ambulance.....                 | 1            | Radio, VHF, Manpack, Low-Power ..... | 1            |

Medical Platoon, Mtzd Inf Bde (Sep and Div), Inf Bde (Sep and Div), Mech Inf Bde (Sep and Div), and Tank Bale, or Arty Regt or SP Arty Regt or Arty Bde or MRL Bde or Engr Bde \_\_\_\_\_

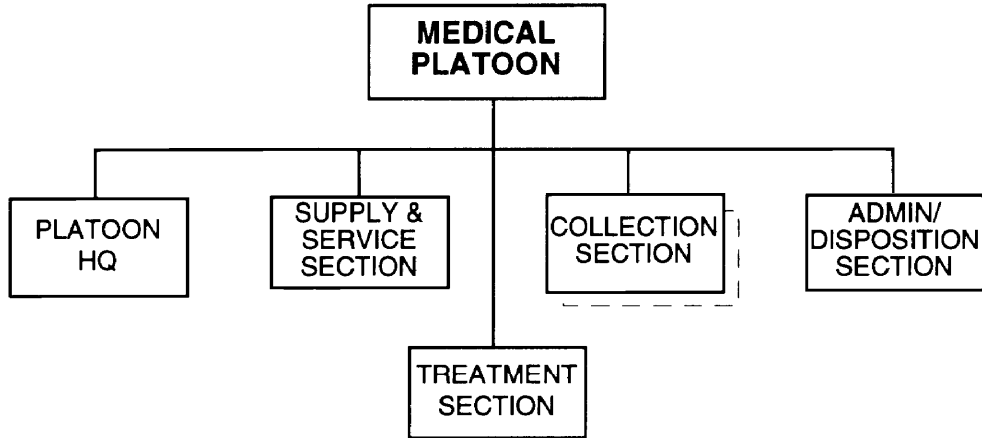

**PRINCIPAL ITEMS OF EQUIPMENT**

| <u>Equipment</u>              | <u>Total</u> | <u>Equipment</u>                     | <u>Total</u> |
|-------------------------------|--------------|--------------------------------------|--------------|
| Van, Hospital .....           | 1            | Ambulance .....                      | 4            |
| Truck, Light .....            | 1            | Trailer, Kitchen .....               | 1            |
| Truck, Medium .....           | 2            | Trailer, Water (900-Liter) .....     | 1            |
| Truck, Decon, DDA-53/66 ..... | 1            | Radio, VHF, Manpack, Low-Power ..... | 1            |

**NOTES:**

1. Other general-purpose trucks may serve as ambulances.
2. Some medical platoons, particularly those in mechanized and tank units, have two collection sections. In that case, there are four additional ambulances.

Infantry Brigade (Separate)

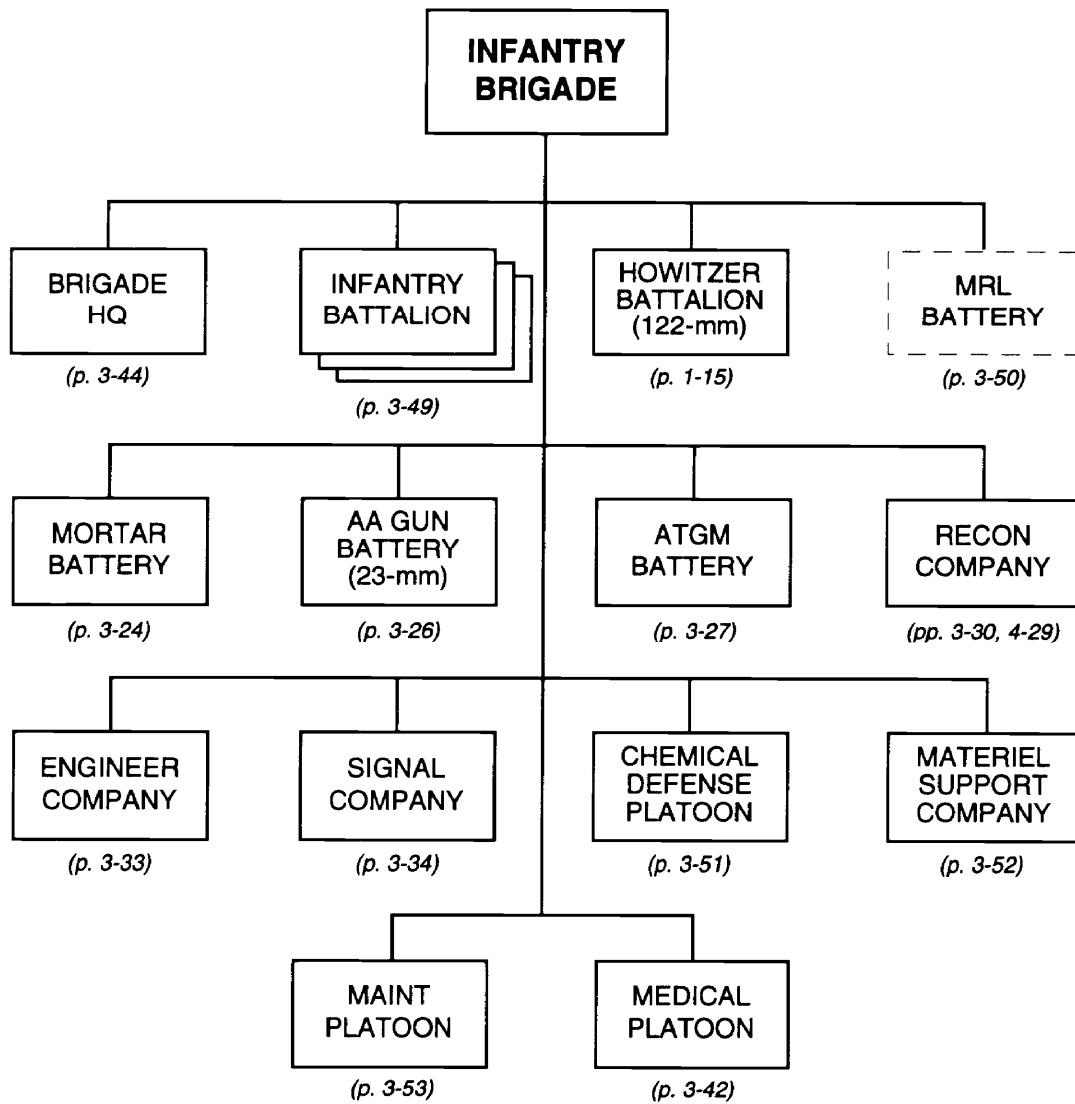

*NOTE:* The MRL battery is not present in all infantry brigades. Therefore, the equipment list below does not include this battery.

(continued)

Infantry Brigade (Separate) (continued)

| <i>Principal Items of Equipment</i> | <i>Brigade HQ</i> | <i>Inf Bn (3x)</i> | <i>Howitzer Bn (122-mm)</i> | <i>Mortar Btry</i> | <i>AA Gun Btry (23-mm)</i> | <i>ATGM Btry</i> | <i>Reconnaissance Co</i> | <i>Engineer Co</i> | <i>Signal Co</i> | <i>Chemical Defense Plt</i> | <i>Materiel Support Co</i> | <i>Maintenance Plt</i> | <i>Medical Plt</i> | <i>TOTAL</i> |
|-------------------------------------|-------------------|--------------------|-----------------------------|--------------------|----------------------------|------------------|--------------------------|--------------------|------------------|-----------------------------|----------------------------|------------------------|--------------------|--------------|
| <b>ARMORED VEHICLES</b>             |                   |                    |                             |                    |                            |                  |                          |                    |                  |                             |                            |                        |                    |              |
| ACV, BRDM-2U                        |                   |                    |                             |                    |                            | 4                |                          |                    |                  |                             |                            |                        |                    | 4            |
| Chem Recon Veh, BRDM-2RKh           |                   |                    |                             |                    |                            |                  |                          |                    |                  | 3                           |                            |                        |                    | 3            |
| ACRV, 1V18 (Battery COP)            |                   |                    | 3                           |                    |                            |                  |                          |                    |                  |                             |                            |                        |                    | 3            |
| ACRV, 1V19 (Battalion COP)          |                   |                    | 1                           |                    |                            |                  |                          |                    |                  |                             |                            |                        |                    | 1            |
| <b>WEAPONS</b>                      |                   |                    |                             |                    |                            |                  |                          |                    |                  |                             |                            |                        |                    |              |
| 30-mm Auto Grenade Lchr, AGS-17     |                   | 18                 |                             |                    |                            |                  |                          |                    |                  |                             |                            |                        |                    | 18           |
| 60-mm Mortar, Light                 |                   | 27                 |                             |                    |                            |                  |                          |                    |                  |                             |                            |                        |                    | 27           |
| 82-mm Mortar, M1937                 |                   | 9                  |                             |                    |                            |                  |                          |                    |                  |                             |                            |                        |                    | 9            |
| 120-mm Mortar, M1943/2S12           |                   |                    |                             | 6                  |                            |                  |                          |                    |                  |                             |                            |                        |                    | 6            |
| 122-mm Howitzer, D-30               |                   |                    | 18                          |                    |                            |                  |                          |                    |                  |                             |                            |                        |                    | 18           |
| 23-mm AA Gun, ZU-23                 |                   |                    |                             |                    | 8                          |                  |                          |                    |                  |                             |                            |                        |                    | 8            |
| SAM, Shoulder-Fired                 | 3                 | 27                 | 18                          |                    |                            |                  |                          |                    |                  |                             |                            |                        |                    | 48           |
| ATGM Manpack, AT-7/SAXHORN          |                   | 9                  |                             |                    |                            |                  |                          |                    |                  |                             |                            |                        |                    | 9            |
| ATGM Vehicle, 9P113 w/ AT-3         |                   |                    |                             |                    |                            | 12               |                          |                    |                  |                             |                            |                        |                    | 12           |
| 73-mm Recoilless Gun, SPG-9         |                   | 6                  |                             |                    |                            |                  |                          |                    |                  |                             |                            |                        |                    | 6            |
| Flamethrower, LPO/RPO               |                   | 27                 |                             |                    |                            |                  |                          | 4                  |                  |                             |                            |                        |                    | 31           |
| <b>ENGINEER EQUIPMENT</b>           |                   |                    |                             |                    |                            |                  |                          |                    |                  |                             |                            |                        |                    |              |
| Bridge, Truck-Launched              |                   |                    |                             |                    |                            |                  |                          | 4                  |                  |                             |                            |                        |                    | 4            |
| Minelayer, PMR                      |                   |                    |                             |                    |                            |                  |                          | 3                  |                  |                             |                            |                        |                    | 3            |
| Mine Detector, DIM                  |                   |                    |                             |                    |                            |                  |                          | 1                  |                  |                             |                            |                        |                    | 1            |
| Truck, Water Purification           |                   |                    |                             |                    |                            |                  |                          | 1                  |                  |                             |                            |                        |                    | 1            |
| <b>TRUCKS</b>                       |                   |                    |                             |                    |                            |                  |                          |                    |                  |                             |                            |                        |                    |              |
| ACRV, 1V110 (Battery FDC)           |                   |                    | 3                           |                    |                            |                  |                          |                    |                  |                             |                            |                        |                    | 3            |
| ACRV, 1V111 (Battalion FDC)         |                   |                    | 1                           |                    |                            |                  |                          |                    |                  |                             |                            |                        |                    | 1            |
| Truck, Utility                      | 2                 | 3                  | 1                           | 1                  | 1                          |                  | 1                        | 4                  | 5                |                             | 2                          |                        |                    | 20           |
| Truck, Light                        | 6                 | 9                  | 9                           | 7                  | 8                          |                  |                          |                    | 3                |                             | 30                         |                        | 1                  | 73           |
| Truck, Medium                       |                   |                    | 34                          |                    |                            | 3                | 3                        | 9                  |                  |                             | 20                         | 2                      | 2                  | 73           |
| Truck, Crane                        |                   |                    |                             |                    |                            |                  |                          | 2                  |                  |                             |                            | 1                      |                    | 3            |
| Truck, Decon, ARS-12U/14            |                   |                    |                             |                    |                            |                  |                          |                    |                  | 1                           |                            |                        |                    | 1            |
| Truck, Decon, DDA-53/66             |                   |                    |                             |                    |                            |                  |                          |                    |                  | 3                           |                            |                        | 1                  | 4            |
| Truck, Dump                         |                   |                    |                             |                    |                            |                  |                          | 2                  |                  |                             |                            |                        |                    | 2            |
| Truck, POL (5,000-L)                |                   |                    | 2                           |                    |                            |                  |                          |                    |                  |                             | 15                         |                        |                    | 17           |
| Truck, Recovery                     |                   |                    |                             |                    |                            |                  |                          |                    |                  |                             |                            | 1                      |                    | 1            |
| Truck, Water (2,000-L)              |                   |                    |                             |                    |                            |                  |                          |                    |                  | 1                           |                            |                        |                    | 1            |
| Van, Command                        | 3                 |                    |                             |                    |                            |                  |                          |                    |                  |                             |                            |                        |                    | 3            |
| Van, Hospital                       |                   |                    |                             |                    |                            |                  |                          |                    |                  |                             |                            |                        | 1                  | 1            |
| Van, Maintenance                    |                   |                    | 1                           |                    |                            |                  |                          | 1                  |                  |                             | 1                          | 4                      |                    | 7            |
| Van, Signal                         |                   |                    | 4                           |                    |                            |                  |                          | 1                  | 10               |                             |                            |                        |                    | 15           |
| Ambulance                           |                   |                    | 1                           |                    |                            |                  |                          |                    |                  |                             |                            |                        | 4                  | 5            |
| <b>TRAILERS</b>                     |                   |                    |                             |                    |                            |                  |                          |                    |                  |                             |                            |                        |                    |              |
| Trailer, Cargo, 1-Axle              |                   |                    |                             |                    |                            |                  |                          | 6                  |                  |                             | 15                         |                        |                    | 21           |
| Trailer, Cargo, 2-Axle              |                   |                    | 11                          |                    |                            |                  |                          | 2                  |                  |                             | 15                         |                        |                    | 28           |
| Trailer, Generator                  |                   |                    | 1                           |                    |                            |                  |                          |                    | 1                |                             | 1                          | 1                      |                    | 4            |
| Trailer, Kitchen                    |                   |                    | 4                           |                    |                            |                  |                          | 1                  |                  |                             | 3                          |                        | 1                  | 9            |
| Trailer, POL (4,200-L)              |                   |                    | 2                           |                    |                            |                  |                          |                    |                  |                             |                            |                        |                    | 2            |
| Trailer, POL (1,200-L)              |                   |                    |                             |                    |                            |                  |                          |                    |                  |                             | 15                         |                        |                    | 15           |
| Trailer, Water (900-/1,200-L)       |                   |                    | 1                           |                    |                            |                  |                          | 1                  |                  | 1                           | 5                          |                        | 1                  | 9            |

(continued)

## Infantry Brigade (Separate) (continued)

| <i>Principal Items of Equipment</i>                                | <i>Brigade HQ</i> | <i>Inf Bn (3x)</i> | <i>Howitzer Bn (122-mm)</i> | <i>Mortar Btry</i> | <i>AA Gun Btry (23-mm)</i> | <i>ATGM Btry</i> | <i>Reconnaissance Co</i> | <i>Engineer Co</i> | <i>Signal Co</i> | <i>Chemical Defense Plt</i> | <i>Materiel Support Co</i> | <i>Maintenance Plt</i> | <i>Medical Plt</i> | <i>TOTAL</i> |
|--|-------------------|--------------------|-----------------------------|--------------------|----------------------------|------------------|--------------------------|--------------------|------------------|-----------------------------|----------------------------|------------------------|--------------------|--------------|
| <b>RADARS</b>  |                   |                    |                             |                    |                            |                  |                          |                    |                  |                             |                            |                        |                    |              |
| Radar, Battlefield Surveillance, Man-Portable, PSNR-1 or TALL MIKE |                   |                    | 1                           |                    |                            | 1                | 3                        |                    |                  |                             |                            |                        |                    | 5            |
| <b>RADIOS</b>  |                   |                    |                             |                    |                            |                  |                          |                    |                  |                             |                            |                        |                    |              |
| VHF, Manpack, Low-Power  | 3                 | 177                | 14                          | 5                  | 3                          | 4                | 11                       | 4                  | 7                |                             | 1                          | 1                      | 1                  | 231          |
| VHF, Portable, Low-Power   |                   | 63                 | 23                          |                    |                            |                  | 4                        |                    |                  |                             |                            |                        |                    | 90           |
| VHF, Portable, Very-Low-Power                                      |                   | 12                 |                             |                    |                            |                  |                          |                    |                  |                             |                            |                        |                    | 12           |
| VHF, Vehicle Mount, Medium-Power                                   | 3                 | 3                  | 8                           | 1                  |                            | 13               | 1                        | 1                  |                  | 3                           |                            |                        |                    | 33           |
| HF, Manpack, Low-Power   |                   |                    |                             |                    |                            |                  |                          |                    | 2                | 1                           |                            |                        |                    | 3            |
| HF, Vehicle Mount, Medium-Power                                    | 1                 | 3                  |                             |                    |                            |                  | 1                        | 1                  | 2                |                             |                            |                        |                    | 8            |
| HF/VHF, Vehicle Mount, Med-Power                                   |                   |                    | 4                           |                    |                            |                  |                          |                    | 8                |                             |                            |                        |                    | 12           |
| HF/VHF, Vehicle Mount, High-Power                                  |                   |                    |                             |                    |                            |                  |                          |                    | 2                |                             |                            |                        |                    | 2            |
| HF, Vehicle Mount, High-Power                                      |                   |                    |                             |                    |                            |                  |                          |                    | 1                |                             |                            |                        |                    | 1            |
| Radio Relay, VHF/UHF   |                   |                    |                             |                    |                            |                  |                          |                    | 2                |                             |                            |                        |                    | 2            |
| Warning Receiver   | 1                 | 3                  | 1                           |                    |                            |                  | 1                        |                    | 3                |                             |                            |                        |                    | 9            |
| <b>MISCELLANEOUS</b>   |                   |                    |                             |                    |                            |                  |                          |                    |                  |                             |                            |                        |                    |              |
| Rangefinder, Steroscopic   |                   | 3                  |                             | 1                  |                            | 1                |                          |                    |                  |                             |                            |                        |                    | 5            |
| Rangefinder, Laser, SAGE GLOSS                                     |                   |                    | 4                           |                    |                            |                  |                          |                    |                  |                             |                            |                        |                    | 4            |
| Periscopic Aiming Circle   |                   | 3                  |                             | 1                  |                            |                  |                          |                    |                  |                             |                            |                        |                    | 4            |
| Collimator   |                   | 9                  |                             | 6                  |                            |                  |                          |                    |                  |                             |                            |                        |                    | 15           |
| Motorcycle   |                   |                    |                             |                    |                            |                  | 9                        |                    | 3                |                             |                            |                        |                    | 12           |

Infantry Brigade (Divisional)

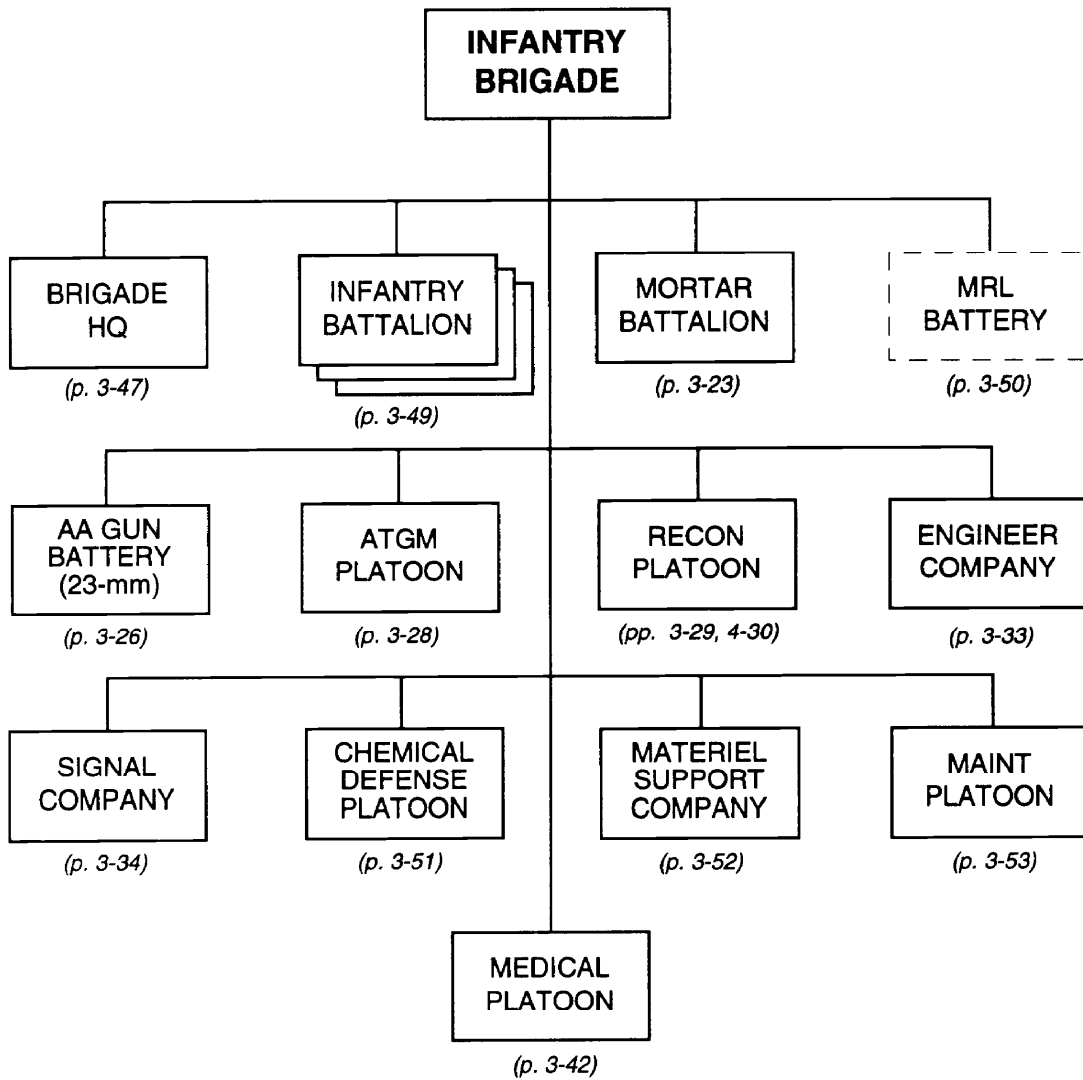

*NOTE:* The MRL battery is not present in all infantry brigades. Therefore, the equipment list below does not include this battery.

(continued)

## Infantry Brigade (Divisional) (continued)

| <i>Principal Items of Equipment</i>                                   | <i>Brigade HQ</i> | <i>Inf Bn (3x)</i> | <i>Mortar Bn</i> | <i>AA Gun Btry (23-mm)</i> | <i>ATGM Plt</i> | <i>Reconnaissance Plt</i> | <i>Engineer Co</i> | <i>Signal Co</i> | <i>Chemical Defense Plt</i> | <i>Material Support Co</i> | <i>Maintenance Plt</i> | <i>Medical Plt</i> | <i>TOTAL</i> |
|---|-------------------|--------------------|------------------|----------------------------|-----------------|---------------------------|--------------------|------------------|-----------------------------|----------------------------|------------------------|--------------------|--------------|
| <b>ARMORED VEHICLES</b>   |                   |                    |                  |                            |                 |                           |                    |                  |                             |                            |                        |                    |              |
| Chem Recon Veh, BRDM-2RKh   |                   |                    |                  |                            |                 |                           |                    |                  | 3                           |                            |                        |                    | 3            |
| <b>WEAPONS</b>  |                   |                    |                  |                            |                 |                           |                    |                  |                             |                            |                        |                    |              |
| 30-mm Auto Grenade Lchr, AGS-17                                       |                   | 18                 |                  |                            |                 |                           |                    |                  |                             |                            |                        |                    | 18           |
| 60-mm Mortar, Light   |                   | 27                 |                  |                            |                 |                           |                    |                  |                             |                            |                        |                    | 27           |
| 82-mm Mortar, M1937   |                   | 9                  |                  |                            |                 |                           |                    |                  |                             |                            |                        |                    | 9            |
| 120-mm Mortar, M1943/2S12 or<br>82-mm Mortar M1937/2B9                |                   |                    | 18               |                            |                 |                           |                    |                  |                             |                            |                        |                    | 18           |
| 23-mm AA Gun, ZU-23   |                   |                    |                  | 8                          |                 |                           |                    |                  |                             |                            |                        |                    | 8            |
| SAM, Shoulder-Fired   | 3                 | 27                 |                  |                            |                 |                           |                    |                  |                             |                            |                        |                    | 30           |
| ATGM Manpack, AT-4/SPIGOT   |                   |                    |                  |                            | 6               |                           |                    |                  |                             |                            |                        |                    | 6            |
| ATGM Manpack, AT-7/SAXHORN  |                   | 9                  |                  |                            |                 |                           |                    |                  |                             |                            |                        |                    | 9            |
| 73-mm Recoiless Gun, SPG-9  |                   | 6                  |                  |                            |                 |                           |                    |                  |                             |                            |                        |                    | 6            |
| Flamethrower, LPO/RPO   |                   | 27                 |                  |                            |                 |                           | 4                  |                  |                             |                            |                        |                    | 31           |
| <b>ENGINEER EQUIPMENT</b>   |                   |                    |                  |                            |                 |                           |                    |                  |                             |                            |                        |                    |              |
| Bridge, Truck-Launched  |                   |                    |                  |                            |                 |                           | 4                  |                  |                             |                            |                        |                    | 4            |
| Minelayer, PMR  |                   |                    |                  |                            |                 |                           | 3                  |                  |                             |                            |                        |                    | 3            |
| Mine Detector, DIM  |                   |                    |                  |                            |                 |                           | 1                  |                  |                             |                            |                        |                    | 1            |
| Truck, Water Purification   |                   |                    |                  |                            |                 |                           | 1                  |                  |                             |                            |                        |                    | 1            |
| <b>TRUCKS</b>   |                   |                    |                  |                            |                 |                           |                    |                  |                             |                            |                        |                    |              |
| Truck, Utility  | 2                 | 3                  | 3                | 1                          |                 |                           | 4                  | 5                |                             | 2                          |                        |                    | 20           |
| Truck, Light  | 6                 | 9                  | 23               | 8                          | 3               |                           |                    | 3                |                             | 40                         |                        | 1                  | 93           |
| Truck, Medium   |                   |                    |                  |                            |                 | 1                         | 9                  |                  |                             | 8                          |                        | 2                  | 22           |
| Truck, Crane  |                   |                    |                  |                            |                 |                           | 2                  |                  |                             |                            | 1                      |                    | 3            |
| Truck, Decon, ARS-12U/14  |                   |                    |                  |                            |                 |                           |                    |                  | 1                           |                            |                        |                    | 1            |
| Truck, Decon, DDA-53/66   |                   |                    |                  |                            |                 |                           |                    |                  | 3                           |                            |                        | 1                  | 4            |
| Truck, Dump   |                   |                    |                  |                            |                 |                           | 2                  |                  |                             |                            |                        |                    | 2            |
| Truck, POL (5,000-L)  |                   |                    | 1                |                            |                 |                           |                    |                  |                             | 10                         |                        |                    | 11           |
| Truck, Recovery   |                   |                    |                  |                            |                 |                           |                    |                  |                             |                            | 1                      |                    | 1            |
| Truck, Water (2,000-L)  |                   |                    |                  |                            |                 |                           |                    |                  | 1                           |                            |                        |                    | 1            |
| Van, Command  | 3                 |                    |                  |                            |                 |                           |                    |                  |                             |                            |                        |                    | 3            |
| Van, Hospital   |                   |                    |                  |                            |                 |                           |                    |                  |                             |                            |                        | 1                  | 1            |
| Van, Maintenance  |                   |                    | 1                |                            |                 |                           | 1                  |                  |                             | 1                          | 4                      |                    | 7            |
| Van, Signal   |                   |                    | 1                |                            |                 |                           | 1                  | 10               |                             |                            |                        |                    | 12           |
| Ambulance   |                   |                    | 1                |                            |                 |                           |                    |                  |                             |                            |                        | 4                  | 5            |
| <b>TRAILERS</b>   |                   |                    |                  |                            |                 |                           |                    |                  |                             |                            |                        |                    |              |
| Trailer, Cargo, 1-Axle  |                   |                    |                  |                            |                 |                           | 6                  |                  |                             | 30                         |                        |                    | 36           |
| Trailer, Cargo, 2-Axle  |                   |                    | 4                |                            |                 |                           | 2                  |                  |                             |                            |                        |                    | 6            |
| Trailer, Generator  |                   |                    | 1                |                            |                 |                           |                    | 1                |                             |                            | 1                      |                    | 3            |
| Trailer, Kitchen  |                   |                    | 3                |                            |                 |                           | 1                  |                  |                             | 4                          |                        | 1                  | 9            |
| Trailer, POL (1,200-L)  |                   |                    | 1                |                            |                 |                           |                    |                  |                             | 10                         |                        |                    | 11           |
| Trailer, Water (900-/1,200-L)   |                   |                    | 1                |                            |                 |                           | 1                  |                  | 1                           | 4                          |                        | 1                  | 8            |
| <b>RADARS</b>   |                   |                    |                  |                            |                 |                           |                    |                  |                             |                            |                        |                    |              |
| Radar, Battlefield Surveillance,<br>Man-Portable, PSNR-1 or TALL MIKE |                   |                    | 1                |                            |                 | 1                         |                    |                  |                             |                            |                        |                    | 2            |

(continued)

Infantry Brigade (Divisional) (continued)

| <i>Principal Items of Equipment</i> | <i>Brigade HQ</i> | <i>Inf Bn (3x)</i> | <i>Mortar Bn</i> | <i>AA Gun Btry (23-mm)</i> | <i>ATGM Plt</i> | <i>Reconnaissance Plt</i> | <i>Engineer Co</i> | <i>Signal Co</i> | <i>Chemical Defense Plt</i> | <i>Material Support Co</i> | <i>Maintenance Plt</i> | <i>Medical Plt</i> | <i>TOTAL</i> |
|-------------------------------------|-------------------|--------------------|------------------|----------------------------|-----------------|---------------------------|--------------------|------------------|-----------------------------|----------------------------|------------------------|--------------------|--------------|
| <b>RADIOS</b>                       |                   |                    |                  |                            |                 |                           |                    |                  |                             |                            |                        |                    |              |
| VHF, Manpack, Low-Power             | 3                 | 177                | 18               | 3                          | 3               | 3                         | 4                  | 7                |                             | 3                          | 1                      | 1                  | 223          |
| VHF, Portable, Low-Power            |                   | 63                 | 2                |                            | 4               | 1                         |                    |                  |                             |                            |                        |                    | 70           |
| VHF, Portable, Very-Low-Power       |                   | 12                 |                  |                            |                 |                           |                    |                  |                             |                            |                        |                    | 12           |
| VHF, Vehicle Mount, Medium-Power    | 3                 | 3                  | 3                |                            |                 |                           | 1                  |                  | 3                           |                            |                        |                    | 13           |
| HF, Manpack, Low-Power              |                   |                    |                  |                            |                 |                           |                    | 2                | 1                           |                            |                        |                    | 3            |
| HF, Vehicle Mount, Medium-Power     | 1                 | 3                  |                  |                            |                 |                           | 1                  | 2                |                             |                            |                        |                    | 7            |
| HF/VHF, Vehicle Mount, Med-Power    |                   |                    | 1                |                            |                 |                           |                    | 8                |                             |                            |                        |                    | 9            |
| HF/VHF, Vehicle Mount, High-Power   |                   |                    |                  |                            |                 |                           |                    | 2                |                             |                            |                        |                    | 2            |
| HF, Vehicle Mount, High-Power       |                   |                    |                  |                            |                 |                           |                    | 1                |                             |                            |                        |                    | 1            |
| Radio Relay, VHF/UHF                |                   |                    |                  |                            |                 |                           |                    | 2                |                             |                            |                        |                    | 2            |
| Warning Receiver                    | 1                 | 3                  | 1                |                            |                 |                           |                    | 3                |                             |                            |                        |                    | 8            |
| <b>MISCELLANEOUS</b>                |                   |                    |                  |                            |                 |                           |                    |                  |                             |                            |                        |                    |              |
| Rangefinder, Steroscopic            |                   | 3                  | 3                |                            |                 |                           |                    |                  |                             |                            |                        |                    | 6            |
| Periscopic Aiming Circle            |                   | 3                  | 3                |                            |                 |                           |                    |                  |                             |                            |                        |                    | 6            |
| Collimator                          |                   | 9                  | 18               |                            |                 |                           |                    |                  |                             |                            |                        |                    | 27           |
| Motorcycle                          |                   |                    |                  |                            |                 | 3                         |                    | 3                |                             |                            |                        |                    | 6            |



**Infantry Battalion, Inf Bde  
(Sep, Div, and Militia) or MD**

---

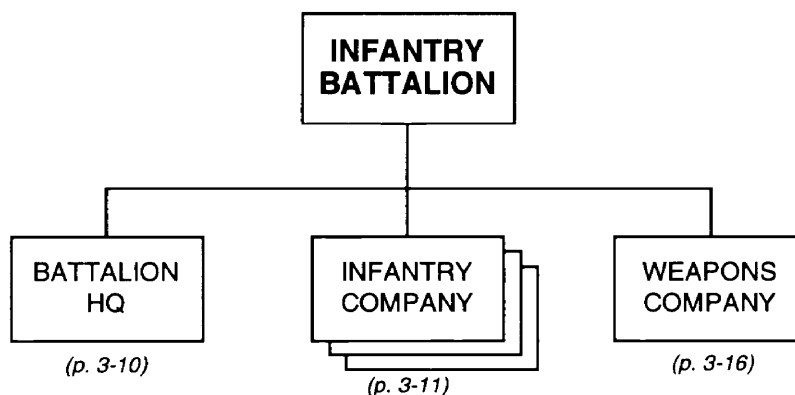

**PRINCIPAL ITEMS OF EQUIPMENT**

| <u>Equipment</u>                                   | <u>Total</u> | <u>Equipment</u>                          | <u>Total</u> |
|--|--------------|---|--------------|
| 9-mm Pistol, PM.....                               | 111          | Truck, Light .....                        | 3            |
| 5.45-mm Assault Rifle, AK-74.....                  | 328          | Rangefinder, Stereoscopic .....           | 1            |
| 5.45-mm LMG, RPK-74.....                           | 54           | Periscopic Aiming Circle, PAB2A .....     | 1            |
| 7.62-mm GP MG, PKM.....                            | 27           | Collimator .....                          | 3            |
| 7.62-mm Sniper Rifle, SVD .....                    | 9            | Night-Vision Goggles .....                | 48           |
| 40-mm Under-Barrel Grenade Launcher,<br>BG-15..... | 79           | Night-Vision Goggles (Driver).....        | 1            |
| 60-mm Mortar, Light .....                          | 9            | Night-Vision Sight (AGL).....             | 6            |
| 82-mm Mortar, M1937 .....                          | 3            | Night-Vision Sight (MG).....              | 27           |
| 30-mm Automatic Grenade Launcher,<br>AGS-17 .....  | 6            | Night-Vision Sight (Small Arms).....      | 59           |
| SAM, Shoulder-Fired.....                           | 9            | Radios:                                   |              |
| ATGM Manpack, AT-7/SAXHORN.....                    | 3            | VHF, Manpack, Low-Power.....              | 59           |
| 73-mm Recoilless Gun, SPG-9.....                   | 2            | VHF, Portable, Low-Power .....            | 21           |
| ATGL, RPG-7V.....                                  | 45           | VHF, Portable, Very-Low-Power .....       | 4            |
| ATRL, RPG-18/22.....                               | 74           | VHF, Vehicle Mount,<br>Medium-Power ..... | 1            |
| Flamethrower, LPO/RPO.....                         | 9            | HF, Vehicle Mount,<br>Medium-Power .....  | 1            |
| Truck, Utility .....                               | 1            | Warning Receiver .....                    | 1            |

*NOTE:* Some infantry battalions may have a mortar battery with nine 82-mm mortars (p. 3-24) instead of a mortar platoon in the weapons company. In that case, there would probably be no 60-mm mortars in the infantry companies.

**Multiple Rocket Launcher Battery, Inf Bde (Sep and Div)  
or Composite Arty Bn, Airborne Inf Bde**

---

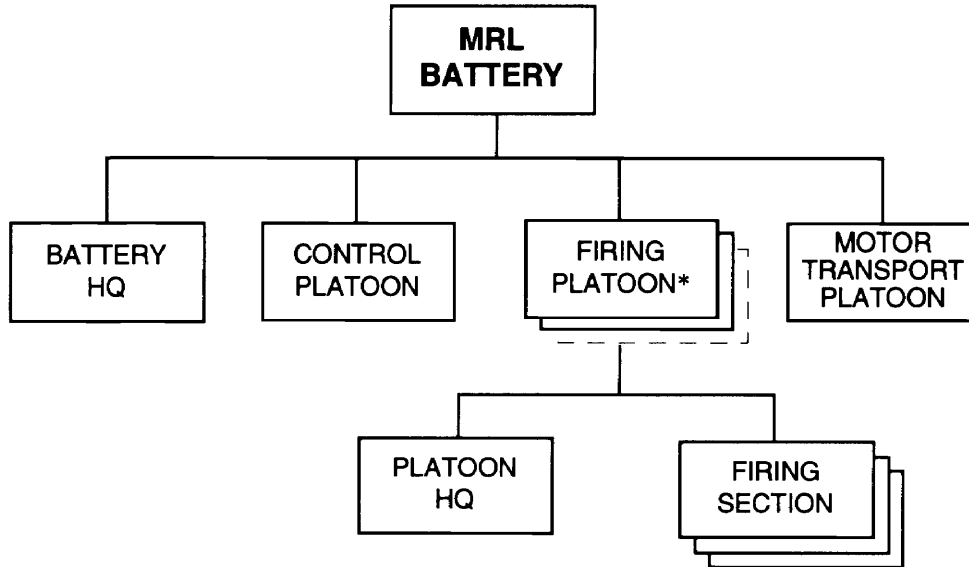

**PRINCIPAL ITEMS OF EQUIPMENT**

| <u>Equipment</u>       | <u>6-Lchr</u> | <u>9-Lchr</u> | <u>Equipment</u>       | <u>6-Lchr</u> | <u>9-Lchr</u> |
|------------------------|---------------|---------------|------------------------|---------------|---------------|
| 140-mm MRL, RPU-14**   | 6             | 9             | Radios:                |               |               |
| ACRV, 1V110            |               |               | VHF, Manpack,          |               |               |
| (Battery FDC)          | 1             | 1             | Low-Power              | 3             | 4             |
| SAM, Shoulder-Fired    | 6             | 9             | VHF, Portable, Very-   |               |               |
| ATRL, RPG-18/22        | 2             | 3             | Low-Power              | 7             | 10            |
| Truck, Utility         |               |               | VHF, Vehicle Mount,    |               |               |
| (Battery COP)          | 1             | 1             | Medium-Power           | 1             | 1             |
| Truck, Light           | 8             | 11            | HF/VHF, Vehicle Mount, |               |               |
| Van, Signal            | 1             | 1             | Medium-Power           | 1             | 1             |
| Trailer, Cargo, 1-Axle | 2             | 2             |                        |               |               |

**FOOTNOTES:**

\* This MRL battery may have either two or three firing platoons. Thus, the number of launchers is either six or nine.

\*\* Some MRL batteries may have the 107-mm towed MRL instead of the 140-mm towed MRL, RPU-14.

**Chemical Defense Platoon,  
Inf Bde (Sep and Div)**

---

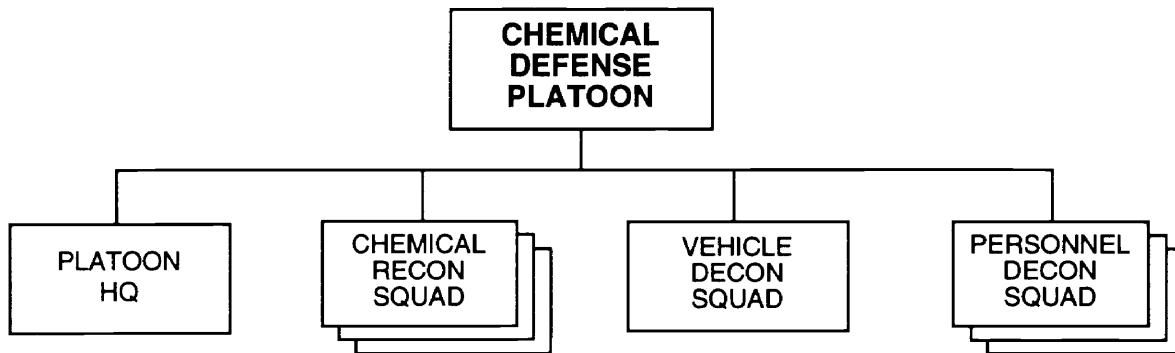

**PRINCIPAL ITEMS OF EQUIPMENT**

| <u>Equipment</u>                            | <u>Total</u> | <u>Equipment</u>                          | <u>Total</u> |
|---|--------------|---|--------------|
| Chemical Recon Vehicle,<br>BRDM-2RKh* ..... | 3            | Trailer, Water (1,200-Liter) .....        | 1            |
| Truck, Decon, ARS-12U/14 .....              | 1            | Radios:                                   |              |
| Truck, Decon, DDA-53/66** .....             | 3            | VHF, Vehicle Mount,<br>Medium-Power ..... | 3            |
| Truck, Water (2,000-Liter) .....            | 1            | HF, Manpack, Low-Power .....              | 1            |

**FOOTNOTES:**

\* Some infantry brigades may use the truck-mounted chemical reconnaissance vehicle UAZ-69RKh instead of the armored BRDM-2RKh.

\*\* Some infantry brigades may use the single-axle DDP decontamination trailer, towed by a light truck, to perform the same personnel decontamination functions as the truck-mounted DDA-53/66.

**Materiel Support Company,  
Inf Bde (Sep and Div)**

---

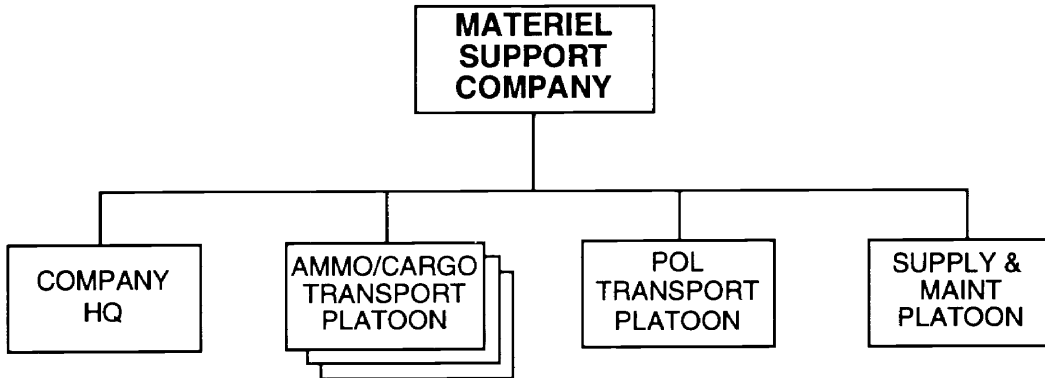

**PRINCIPAL ITEMS OF EQUIPMENT**

| <u>Equipment</u>              | <u>Sep</u> | <u>Div</u> |
|-------------------------------|------------|------------|
| Truck, Utility .....          | 2          | 2          |
| Truck, Light .....            | 30         | 40         |
| Truck, Medium .....           | 20         | 8          |
| Truck, POL (4,000-Liter)..... | 15         | 10         |
| Van, Maintenance .....        | 1          | 1          |
| Trailer, Cargo, 1-Axle.....   | 15         | 30         |
| Trailer, Cargo, 2-Axle.....   | 15         | 0          |

| <u>Equipment</u>                       | <u>Sep</u> | <u>Div</u> |
|--|------------|------------|
| Trailer, Generator.....                | 1          | 1          |
| Trailer, Kitchen.....                  | 3          | 2          |
| Trailer, POL (1,200-Liter) .....       | 15         | 10         |
| Trailer, Water (900-Liter) .....       | 5          | 4          |
| Radio, VHF, Manpack,<br>Low-Power..... | 1          | 1          |

Maintenance Platoon, Inf Bde (Sep and Div) \_\_\_\_\_

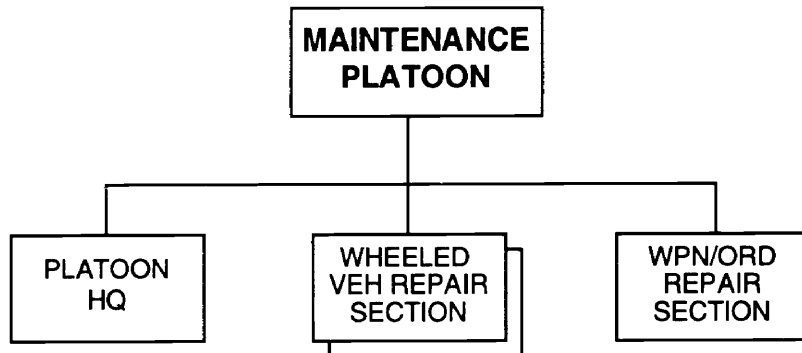

**PRINCIPAL ITEMS OF EQUIPMENT**

| <u>Equipment</u>       | <u>Total</u> | <u>Equipment</u>                     | <u>Total</u> |
|------------------------|--------------|--------------------------------------|--------------|
| Van, Maintenance ..... | 4            | Truck, Recovery .....                | 2            |
| Truck, Crane .....     | 1            | Trailer, Generator.....              | 1            |
| Truck, Medium .....    | 2            | Radio, VHF, Manpack, Low-Power ..... | 1            |

Infantry Brigade (Militia)

---

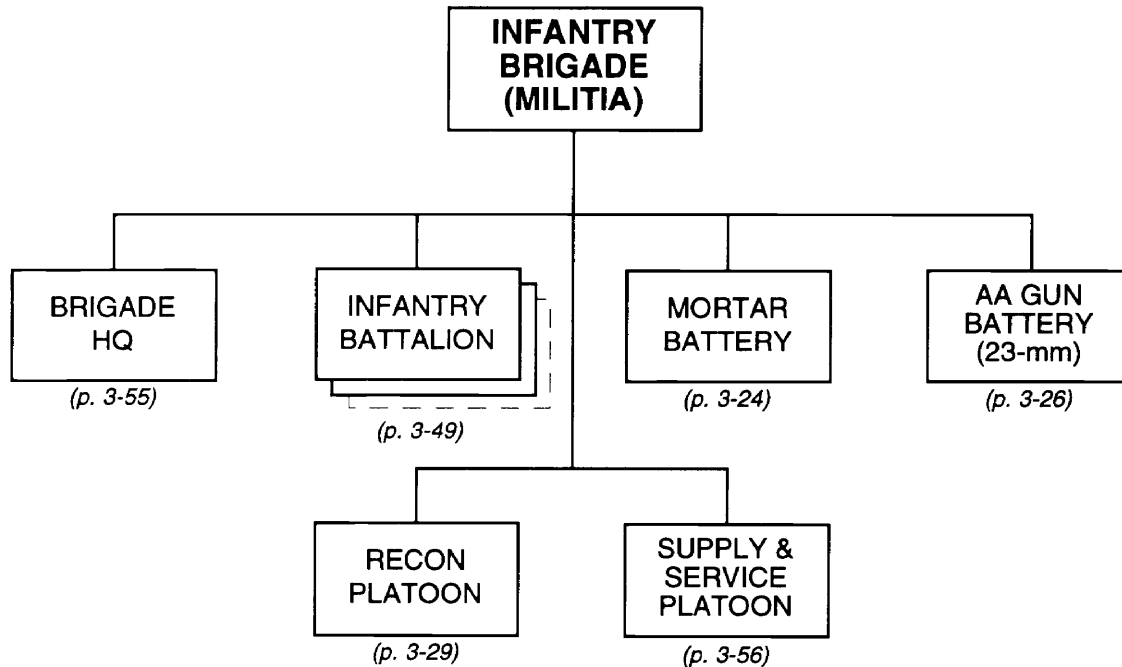

**NOTES:**

1. Districts, depending on their population/population centers, may or may not be able to constitute a brigade-sized militia force; many districts have, at most, a battalion. These forces may or may not act as an integrated force. Regardless of militia size, every village, farm cooperative, or factory has a militia formation, manned in wartime by the workers and peasants, over-age reservists, medically-retired soldiers, women, and young men not yet old enough for military service. The militia could receive additional combat support and combat service support assets from the district, but this would be extremely rare.
2. Although included in the equipment totals of some of the subordinate units referenced above, night-vision sights or goggles are not normally organic to militia forces.

**(continued)**

## Infantry Brigade (Militia)

| <i>Principal Items of Equipment</i>                                   | <i>Brigade HQ</i> | <i>Infantry Bn (2x)</i> | <i>Mortar Btry</i> | <i>AA Gun Btry (23-mm)</i> | <i>Recon Plt</i> | <i>Supply &amp; Service Plt</i> | <i>TOTAL</i> |
|---|-------------------|-------------------------|--------------------|----------------------------|------------------|---------------------------------|--------------|
| <b>WEAPONS</b>  |                   |                         |                    |                            |                  |                                 |              |
| 30-mm Auto Grenade Lchr, AGS-17                                       |                   | 12                      |                    |                            |                  |                                 | 12           |
| 60-mm Mortar, Light   |                   | 18                      |                    |                            |                  |                                 | 18           |
| 82-mm Mortar, M1937   |                   | 6                       |                    |                            |                  |                                 | 6            |
| 120-mm Mortar, M1943/2S12   |                   |                         | 6                  |                            |                  |                                 | 6            |
| 73-mm Recoilless Gun, SPG-9   |                   | 4                       |                    |                            |                  |                                 | 4            |
| ATGM Manpack, AT-7/SAXHORN  |                   | 6                       |                    |                            |                  |                                 | 6            |
| 23-mm AA Gun, ZU-23   |                   |                         |                    | 8                          |                  |                                 | 8            |
| SAM, Shoulder-Fired   | 3                 | 18                      |                    |                            |                  |                                 | 21           |
| Flamethrower, LPO/RPO   |                   | 18                      |                    |                            |                  |                                 | 18           |
| <b>TRUCKS</b>   |                   |                         |                    |                            |                  |                                 |              |
| Truck, Utility  | 3                 | 2                       | 1                  | 1                          |                  | 1                               | 8            |
| Truck, Light  | 6                 | 6                       | 7                  | 8                          |                  | 10                              | 37           |
| Truck, POL (4,000-L)  |                   |                         |                    |                            |                  | 2                               | 2            |
| Van, Maintenance  |                   |                         |                    |                            |                  | 1                               | 1            |
| Van, Signal   | 1                 |                         |                    |                            |                  |                                 | 1            |
| Ambulance   |                   |                         |                    |                            |                  | 1                               | 1            |
| <b>TRAILERS</b>   |                   |                         |                    |                            |                  |                                 |              |
| Trailer, Cargo, 1-Axle  |                   |                         |                    |                            |                  | 5                               | 5            |
| Trailer, Kitchen  |                   |                         |                    |                            |                  | 2                               | 2            |
| Trailer, POL (1,200-L)  |                   |                         |                    |                            |                  | 2                               | 2            |
| Trailer, Water (900-L)  |                   |                         |                    |                            |                  | 3                               | 3            |
| <b>RADARS</b>   |                   |                         |                    |                            |                  |                                 |              |
| Radar, Battlefield Surveillance,<br>Man-Portable, PSNR-1 or TALL MIKE |                   |                         |                    |                            | 1                |                                 | 1            |
| <b>RADIOS</b>   |                   |                         |                    |                            |                  |                                 |              |
| VHF, Manpack, Low-Power   | 6                 | 118                     | 5                  | 3                          | 3                | 1                               | 136          |
| VHF, Portable, Low-Power  |                   | 42                      |                    |                            | 1                |                                 | 43           |
| VHF, Portable, Very-Low-Power   | 3                 | 8                       |                    |                            |                  |                                 | 11           |
| VHF, Vehicle Mount, Medium-Power                                      | 1                 | 2                       | 1                  |                            |                  |                                 | 4            |
| HF, Vehicle Mount, Medium-Power                                       | 1                 | 2                       |                    |                            |                  |                                 | 3            |
| Warning Receiver  | 1                 | 2                       |                    | 1                          |                  |                                 | 4            |
| <b>MISCELLANEOUS</b>  |                   |                         |                    |                            |                  |                                 |              |
| Rangefinder, Stereoscopic   |                   | 2                       | 1                  |                            |                  |                                 | 3            |
| Periscopic Aiming Circle, PAB2A                                       |                   | 2                       | 1                  |                            |                  |                                 | 3            |
| Collimator  |                   | 6                       | 6                  |                            |                  |                                 | 12           |
| Motorcycle  |                   |                         |                    |                            | 3                |                                 | 3            |

Supply and Service Platoon,  
Inf Bde (Militia)

---

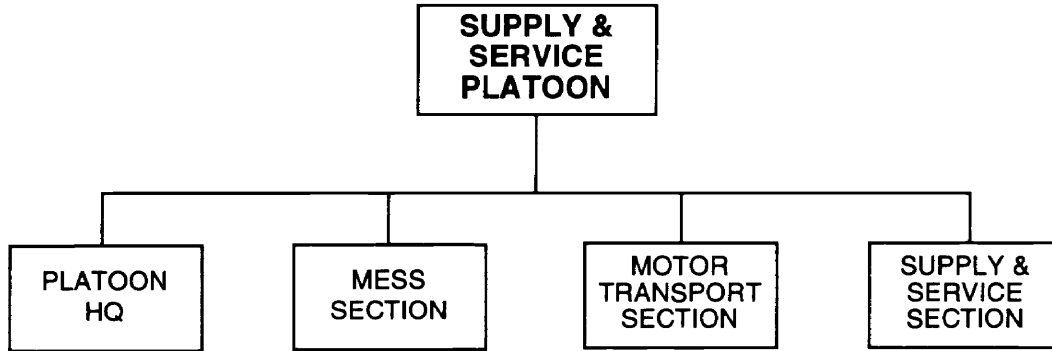

**PRINCIPAL ITEMS OF EQUIPMENT**

| <u>Equipment</u>              | <u>Total</u> | <u>Equipment</u>                     | <u>Total</u> |
|-------------------------------|--------------|--------------------------------------|--------------|
| Truck, Utility .....          | 1            | Trailer, Cargo, 1-Axle.....          | 5            |
| Truck, Light .....            | 10           | Trailer, Kitchen.....                | 2            |
| Truck, POL (4,000-Liter)..... | 2            | Trailer, POL (900-Liter) .....       | 2            |
| Van, Maintenance .....        | 1            | Trailer, Water (900-Liter) .....     | 3            |
| Ambulance .....               | 1            | Radio, VHF, Manpack, Low-Power ..... | 1            |



# Chapter 4

## Mechanized Infantry and Tank Brigades

The basic maneuver unit is the **brigade**, consisting of maneuver battalions and a wide array of combat support and combat service support elements.<sup>1</sup> A **separate** brigade is not part of a division. Instead, it is directly subordinate to a military district or an army. In contrast, a **divisional** brigade is always part of a division.<sup>2</sup>

An infantry-based OPFOR consists primarily of motorized infantry or infantry units. However, even an infantry-based OPFOR has some **mechanized infantry** and tank brigades. The mechanized infantry brigade has two basic types: one equipped with **armored personnel carriers (APCs)** and one equipped with **infantry fighting vehicles (IFVs)**. Each type also has separate and divisional versions. A mechanized infantry brigade may have some subordinates in common with a division (see Chapters 1 and 2). For brigade subordinates also common to motorized infantry brigades, see Chapter 3.

### CONTENTS

|  |      |
|--|------|
| <b>Mechanized Infantry Brigade (Separate)</b> .....                                | 4-3  |
| Mechanized Infantry Brigade (APC) (Separate) .....                                 | 4-4  |
| Mechanized Infantry Brigade (IFV) (Separate) .....                                 | 4-6  |
| <b>Mechanized Infantry Brigade (Divisional)</b> .....                              | 4-8  |
| Mechanized Infantry Brigade (APC) (Divisional) .....                               | 4-9  |
| Mechanized Infantry Brigade (IFV) (Divisional) .....                               | 4-11 |
| Mechanized Infantry Battalion (APC), Mech Inf Bde (Sep and Div) .....              | 4-13 |
| Mechanized Infantry Battalion (IFV), Mech Inf Bde (Sep and Div) and Tank Bde ..... | 4-13 |
| Battalion Headquarters, Mech Inf Bn .....  | 4-15 |
| Mechanized Infantry Company, Mech Inf Bn .....                                     | 4-16 |
| Mechanized Infantry Platoon, Mech Inf Co .....                                     | 4-17 |
| Mechanized Infantry Squad, Mech Inf Plt .....                                      | 4-18 |
| SAM Platoon, Mech Inf Bn or SAM Bn (SA-11) .....                                   | 4-19 |
| Automatic Grenade Launcher Platoon, Mech Inf Bn .....                              | 4-20 |
| Automatic Grenade Launcher Squad, AGL Plt, Mech Inf Bn .....                       | 4-21 |
| Antitank Platoon, Mech Inf Bn (APC) .....  | 4-22 |
| ATGM Platoon, Mech Inf Bn (IFV) .....  | 4-23 |
| Supply and Service Platoon, Mech Inf Bn .....                                      | 4-24 |

---

<sup>1</sup>Some infantry-based forces may call the same organization a **regiment**. This difference in terminology does not signify a different structure or capability.

<sup>2</sup>Since the infantry-based OPFOR has no tank divisions, all tank brigades are actually separate. With no divisional counterpart, however, the designation as separate is superfluous.

|   |      |
|---|------|
| Self-Propelled Antiaircraft Gun Battery (23-mm), Mech Inf Bde (Sep and Div)<br>and Tank Bde or SP Arty Regt .....   | 4-25 |
| Antitank Battalion, Mech Inf Bde (Sep) or Mech Inf Div, or Army<br>or CDF or National .....   | 4-26 |
| Battalion Headquarters, Antitank Bn, Mech Inf Bde (Sep) or Mech Inf Div<br>or CDF or National .....   | 4-27 |
| Antitank Gun Battery, Antitank Bn, Mech Inf Bde (Sep) or Mech Inf Div<br>or CDF or National .....   | 4-28 |
| Reconnaissance Company, Mech Inf Bde (APC) (Sep), Mtzd Inf Bde (Sep),<br>and Inf Bde (Sep) .....  | 4-29 |
| Reconnaissance Platoon (Wheeled), Mtzd Inf Bde (Div) and Inf Bde (Div),<br>or Recon Co, Mtzd Inf Bde (Sep), Inf Bde (Sep),<br>Mech Inf Bde (APC or IFV) (Sep), and Tank Bde .....                   | 4-30 |
| Reconnaissance Company, Mech Inf Bde (IFV) (Sep) and Tank Bde .....   | 4-31 |
| Reconnaissance Platoon (Tracked), Mech Inf Bde (IFV) (Div),<br>or Recon Co, Mech Inf Bde (IFV) (Sep) and Tank Bde,<br>or Recon Co, Recon & EC Bn, Mech Inf Div<br>or MD or Army or CDF or DMI ..... | 4-32 |
| Engineer Company, Mech Inf Bde (Sep and Div) or Mech Inf Div or MD .....  | 4-33 |
| Signal Company, Mech Inf Bde (Sep and Div) and Tank Bde, or Mech Inf Div or MD ....   | 4-34 |
| Maintenance Company, Mech Inf Bde (Sep and Div) and Tank Bde, or MD .....   | 4-35 |
| <b>Tank Brigade (94-Tank Standard)</b> .....  | 4-36 |
| Tank Battalion (31-Tank Standard ), Tank Bde (94-Tank Standard) .....   | 4-39 |
| Battalion Headquarters, Tank Bn, Tank Bde or Separate Tank Bn .....   | 4-40 |
| Headquarters and Service Platoon, Tank Bn, Tank Bde .....   | 4-40 |
| Tank Company (10-Tank Standard), Tank Bn (31-Tank Standard)<br>or Separate Tank Bn .....  | 4-41 |
| Engineer Company, Tank Bde .....  | 4-42 |
| Materiel Support Company, Tank Bde .....  | 4-43 |
| <b>Tank Brigade (67-Tank Variant)</b> .....   | 4-44 |
| Tank Battalion (22-Tank Variant), Tank Bde (67-Tank Variant) .....  | 4-47 |
| Tank Company (7-Tank Variant), Tank Bn (22-Tank Variant)<br>or Separate Tank Bn .....   | 4-48 |

Mechanized Infantry Brigade (Separate) \_\_\_\_\_

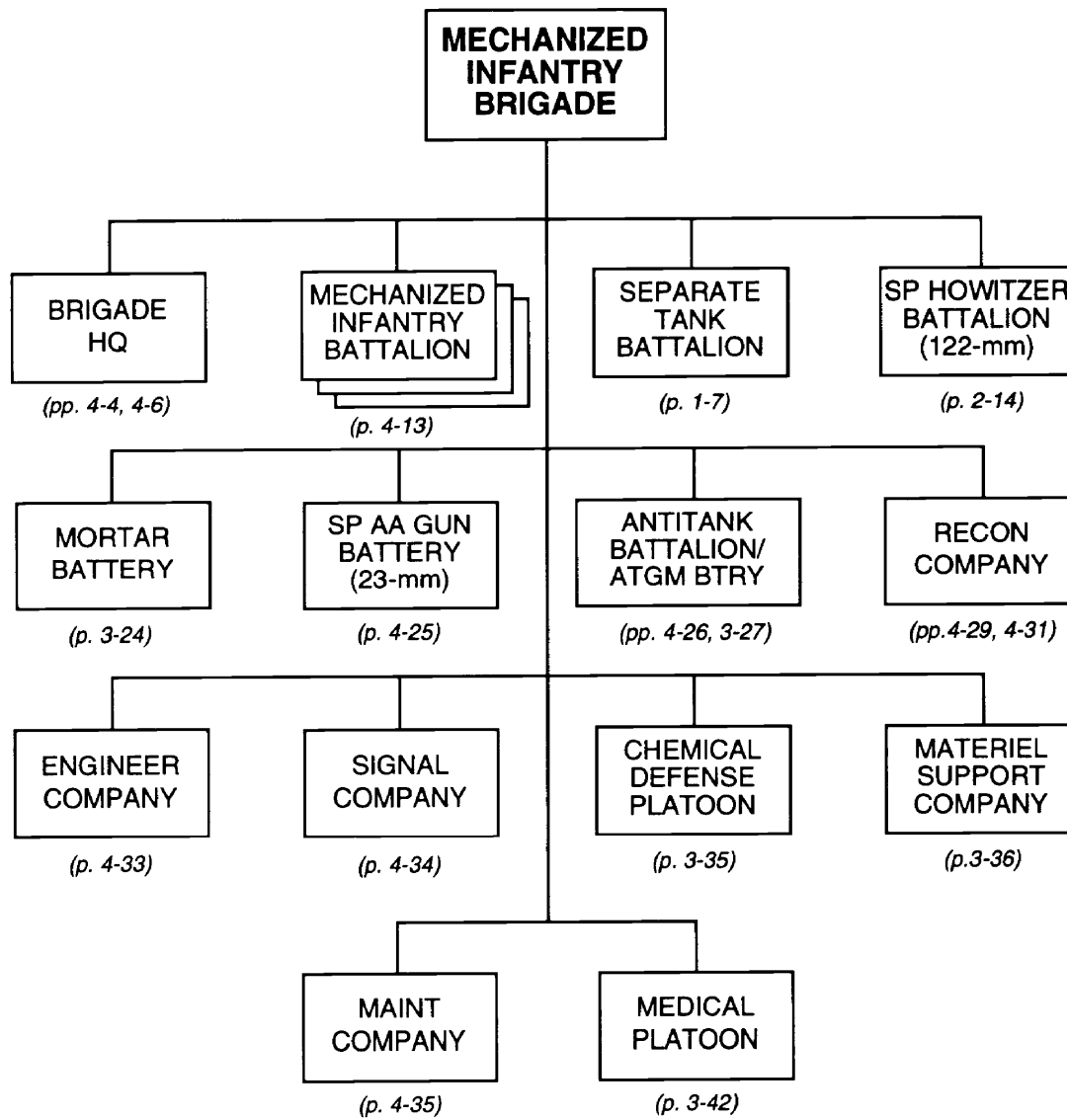

**NOTES:**

1. A mechanized infantry brigade normally has all mechanized infantry battalions of the same type (APC-equipped or IFV-equipped). In rare cases, however, a mix of the two battalion types may occur.
2. The principle items of equipment that follow depict normal brigade structures. These have either all APC-equipped mechanized infantry battalions or all IFV-equipped battalions.

**(continued)**

Mechanized Infantry Brigade (Separate)

| Principal Items of Equipment                           | Brigade HQ | Mech Inf Bn (APC) (3x) | Separate Tank Bn | SP Howitzer Bn (122-mm) | Mortar Btry | SP AA Gun Btry (23-mm) | Antitank Bn* | Reconnaissance Co | Engineer Co | Signal Co | Chemical Defense Plt | Materiel Support Co | Maintenance Co | Medical Plt | TOTAL |
|--|------------|------------------------|------------------|-------------------------|-------------|------------------------|--------------|-------------------|-------------|-----------|----------------------|---------------------|----------------|-------------|-------|
| <b>ARMORED VEHICLES</b>                                |            |                        |                  |                         |             |                        |              |                   |             |           |                      |                     |                |             |       |
| ACV, BTR-60PBK/70K/80K                                 | 1          | 6                      |                  |                         |             |                        |              |                   |             |           |                      |                     |                |             | 7     |
| APC, BTR-60/70/80                                      | 1          | 123                    |                  |                         |             |                        |              |                   |             |           |                      |                     |                |             | 124   |
| APC, BTR-60PA (FAC)                                    | 1          |                        |                  |                         |             |                        |              |                   |             |           |                      |                     |                |             | 1     |
| APC, BTR-60 (PU-12)                                    |            |                        |                  |                         |             | 1                      |              |                   |             |           |                      |                     |                |             | 1     |
| ACV, BTR (R-145BM)                                     |            | 3                      | 2                |                         |             |                        | 1            |                   | 1           | 8         |                      |                     |                |             | 15    |
| ACV, BMP-1K/2K   |            |                        | 1                |                         |             |                        |              |                   |             |           |                      |                     |                |             | 1     |
| Mobile Recon Post, PRP-3/4**                           |            |                        |                  | 1                       |             |                        | 1            |                   |             |           |                      |                     |                |             | 2     |
| ASC, BRDM-2  |            |                        |                  |                         |             |                        |              | 8                 |             |           |                      |                     |                |             | 8     |
| ACV, BRDM-2U   |            |                        |                  |                         |             |                        | 4            | 1                 |             |           |                      |                     |                |             | 5     |
| Chem Recon Vehicle, BRDM-2RKh/RKhM                     |            |                        |                  |                         |             |                        |              |                   |             | 3         |                      |                     |                |             | 3     |
| Prime Mover, MT-LBT                                    |            |                        |                  |                         |             |                        | 14           |                   |             |           |                      |                     |                |             | 14    |
| ACRV, 1V13/1V13M/1V22 (Btry FDC)                       |            |                        |                  | 3                       |             |                        |              |                   |             |           |                      |                     |                |             | 3     |
| ACRV, 1V14/1V14M/1V23 (Btry COP)                       |            |                        |                  | 3                       |             |                        |              |                   |             |           |                      |                     |                |             | 3     |
| ACRV, 1V15/1V15M/1V24 (Bn COP)                         |            |                        |                  | 1                       |             |                        |              |                   |             |           |                      |                     |                |             | 1     |
| ACRV, 1V16/1V16M/1V25 (Bn FDC)                         |            |                        |                  | 1                       |             |                        |              |                   |             |           |                      |                     |                |             | 1     |
| Medium Tank, T-55K/62K                                 |            |                        | 1                |                         |             |                        |              |                   |             |           |                      |                     |                |             | 1     |
| Medium Tank, T-55/62                                   |            |                        | 30               |                         |             |                        |              |                   |             |           |                      |                     |                |             | 30    |
| Armored Recovery Vehicle                               |            |                        | 2                |                         |             |                        |              |                   |             |           |                      |                     | 3              |             | 5     |
| <b>WEAPONS</b>   |            |                        |                  |                         |             |                        |              |                   |             |           |                      |                     |                |             |       |
| 30-mm Auto Grenade Lchr, AGS-17                        |            | 18                     |                  |                         |             |                        |              |                   |             |           |                      |                     |                |             | 18    |
| 73-mm Recoilless Gun, SPG-9                            |            | 9                      |                  |                         |             |                        |              |                   |             |           |                      |                     |                |             | 9     |
| 120-mm Mortar, M1943/2S12 or<br>82-mm Mortar M1937/2B9 |            | 18                     |                  |                         | 6           |                        |              |                   |             |           |                      |                     |                |             | 24    |
| 122-mm SP Howitzer, 2S1                                |            |                        |                  | 18                      |             |                        |              |                   |             |           |                      |                     |                |             | 18    |
| 100-mm AT Gun, T-12/MT-12                              |            |                        |                  |                         |             |                        | 12           |                   |             |           |                      |                     |                |             | 12    |
| ATGM Manpack, AT-4/SPIGOT                              |            | 18                     |                  |                         |             |                        |              |                   |             |           |                      |                     |                |             | 18    |
| ATGM Vehicle, w/AT-3/5                                 |            |                        |                  |                         |             |                        | 9            |                   |             |           |                      |                     |                |             | 9     |
| 23-mm SP AA Gun, ZSU-23-4***                           |            |                        |                  |                         |             | 8                      |              |                   |             |           |                      |                     |                |             | 8     |
| SAM, Shoulder-Fired                                    | 3          | 27                     |                  | 18                      |             |                        |              |                   |             |           |                      |                     |                |             | 48    |
| Flamethrower, LPO/RPO                                  |            | 27                     | 2                |                         |             |                        |              |                   | 4           |           |                      |                     |                |             | 33    |
| <b>ENGINEER EQUIPMENT</b>                              |            |                        |                  |                         |             |                        |              |                   |             |           |                      |                     |                |             |       |
| Bridge, Tank-Launched                                  |            |                        | 1                |                         |             |                        |              |                   | 1           |           |                      |                     |                |             | 2     |
| Bridge, Truck-Launched                                 |            |                        |                  |                         |             |                        |              |                   | 4           |           |                      |                     |                |             | 4     |
| Ditching Machine, BTM/MDK                              |            |                        | 1                |                         |             |                        |              |                   |             |           |                      |                     |                |             | 1     |
| Ditching Machine, PZM/TMK                              |            |                        |                  |                         |             |                        |              |                   | 4           |           |                      |                     |                |             | 4     |
| Route-Clearing Vehicle, BAT/PKT                        |            |                        | 1                |                         |             |                        |              |                   | 1           |           |                      |                     |                |             | 2     |
| Armored Engineer Tractor, IMR                          |            |                        |                  |                         |             |                        |              |                   | 1           |           |                      |                     |                |             | 1     |
| Minelayer, GMZ   |            |                        |                  |                         |             |                        |              |                   | 3           |           |                      |                     |                |             | 3     |
| Mineclearing Plow                                      |            |                        | 9                |                         |             |                        |              |                   |             |           |                      |                     |                |             | 9     |
| Mine Roller-Plow                                       |            |                        | 3                |                         |             |                        |              |                   |             |           |                      |                     |                |             | 3     |
| Mine Detector, DIM                                     |            |                        |                  |                         |             |                        |              |                   | 1           |           |                      |                     |                |             | 1     |
| Truck, Water Purification                              |            |                        |                  |                         |             |                        |              |                   | 1           |           |                      |                     |                |             | 1     |

FOOTNOTES:

\* Some separate mechanized infantry brigades (APC) may have only an ATGM battery (see p. 3-27).

\*\* This vehicle includes the SMALL FRED or TALL MIKE battlefield surveillance radar.

\*\*\* This vehicle includes the GUN DISH fire control radar.

(continued)

## Mechanized Infantry Brigade (APC) (Separate) (continued)

| Principal Items of Equipment                                       | Brigade HQ | Mech Inf Bn (APC) (3x) | Separate Tank Bn | SP Howitzer Bn (122-mm) | Mortar Btry | SP AA Gun Btry (23-mm) | Antitank Bn* | Reconnaissance Co | Engineer Co | Signal Co | Chemical Defense Plt | Materiel Support Co | Maintenance Co | Medical Plt | TOTAL |
|--|------------|------------------------|------------------|-------------------------|-------------|------------------------|--------------|-------------------|-------------|-----------|----------------------|---------------------|----------------|-------------|-------|
| <b>TRUCKS</b>  |            |                        |                  |                         |             |                        |              |                   |             |           |                      |                     |                |             |       |
| Truck, Utility   | 3          | 12                     | 1                |                         | 1           |                        | 3            |                   | 4           | 5         |                      | 2                   | 1              |             | 32    |
| Truck, Light   |            | 39                     | 1                | 4                       | 7           | 1                      | 4            |                   |             | 3         |                      | 4                   |                | 1           | 64    |
| Truck, Medium  | 1          | 12                     | 13               | 14                      |             | 4                      | 12           |                   | 9           |           |                      | 45                  | 2              | 2           | 114   |
| Truck, Crane   |            |                        | 1                |                         |             |                        |              |                   | 1           |           |                      |                     |                |             | 2     |
| Truck, Crane Shovel  |            |                        |                  |                         |             |                        |              |                   | 1           |           |                      |                     |                |             | 1     |
| Truck, Decon, ARS-12U/14   |            |                        |                  |                         |             |                        |              |                   |             |           | 3                    |                     |                |             | 3     |
| Truck, Decon, DDA-53/66  |            |                        |                  |                         |             |                        |              |                   |             |           | 1                    |                     |                | 1           | 2     |
| Truck, Dump  |            |                        |                  |                         |             |                        |              | 2                 |             |           |                      |                     |                |             | 2     |
| Truck, POL (5,000-L)   |            | 9                      | 5                | 2                       |             |                        | 3            |                   |             |           |                      | 15                  |                |             | 34    |
| Truck, Water (2,000-L)   |            |                        |                  |                         |             |                        |              |                   |             |           | 2                    | 4                   |                |             | 6     |
| Van, Command   | 3          |                        |                  |                         |             |                        |              |                   |             |           |                      |                     |                |             | 3     |
| Van, Hospital  |            |                        |                  |                         |             |                        |              |                   |             |           |                      |                     |                | 1           | 1     |
| Van, Kitchen   |            | 3                      | 1                |                         |             |                        |              |                   |             |           |                      |                     |                |             | 4     |
| Van, Maintenance   |            | 3                      | 1                | 2                       |             |                        | 2            |                   | 1           |           |                      | 1                   | 9              |             | 19    |
| Van, Signal  |            | 3                      | 2                | 4                       |             |                        | 2            |                   |             | 2         |                      |                     |                |             | 13    |
| Ambulance  |            | 3                      | 1                | 1                       |             |                        | 1            |                   |             |           |                      |                     |                | 4           | 10    |
| <b>TRAILERS</b>  |            |                        |                  |                         |             |                        |              |                   |             |           |                      |                     |                |             |       |
| Trailer, Cargo, 1-Axle   |            | 6                      | 1                |                         |             |                        |              |                   | 6           |           |                      |                     |                |             | 13    |
| Trailer, Cargo, 2-Axle   |            |                        | 7                | 16                      |             |                        | 10           |                   | 2           |           |                      | 30                  |                |             | 65    |
| Trailer, Generator   |            | 3                      | 3                | 2                       |             | 2                      | 1            |                   | 1           |           |                      | 1                   | 6              |             | 19    |
| Trailer, Kitchen   |            | 9                      |                  | 3                       |             |                        | 1            |                   | 1           |           |                      | 2                   | 3              | 1           | 20    |
| Trailer, POL (4,200-L)   |            | 3                      | 5                | 2                       |             |                        | 3            |                   |             |           |                      | 15                  |                |             | 28    |
| Trailer, POL (1,200-L)   |            | 3                      |                  |                         |             |                        |              |                   |             |           |                      |                     |                |             | 3     |
| Trailer, Water (900-/1,200-L)                                      |            | 3                      | 1                | 1                       |             |                        | 1            |                   | 1           |           | 2                    | 1                   |                | 1           | 11    |
| <b>RADARS</b>  |            |                        |                  |                         |             |                        |              |                   |             |           |                      |                     |                |             |       |
| Radar, Battlefield Surveillance, Man-Portable, PSNR-1 or TALL MIKE |            |                        |                  |                         |             |                        | 3            | 2                 |             |           |                      |                     |                |             | 5     |
| <b>RADIOS</b>  |            |                        |                  |                         |             |                        |              |                   |             |           |                      |                     |                |             |       |
| VHF, Manpack, Low-Power  | 3          | 48                     | 5                | 10                      | 5           |                        | 10           |                   | 4           | 7         |                      | 1                   | 1              | 1           | 95    |
| VHF, Portable, Low-Power   |            | 75                     |                  |                         |             | 1                      |              | 13                |             |           |                      |                     |                |             | 89    |
| VHF, Portable, Very-Low-Power                                      |            | 12                     |                  |                         |             |                        |              |                   |             |           |                      |                     |                |             | 12    |
| VHF, Vehicle Mount, Medium-Power                                   | 3          | 138                    | 37               | 27                      | 1           | 9                      | 28           | 9                 | 6           | 8         | 3                    |                     | 3              |             | 272   |
| HF, Manpack, Low-Power   |            |                        | 2                |                         |             |                        |              |                   |             | 2         | 1                    |                     |                |             | 5     |
| HF, Vehicle Mount, Medium-Power                                    | 1          | 6                      | 6                |                         |             |                        | 1            | 1                 | 1           | 2         |                      |                     |                |             | 18    |
| HF/VHF, Vehicle Mount, Med-Power                                   |            | 3                      |                  | 4                       |             |                        | 3            |                   |             | 2         |                      |                     |                |             | 12    |
| HF/VHF, Vehicle Mount, High-Power                                  |            |                        |                  |                         |             |                        |              |                   |             | 2         |                      |                     |                |             | 2     |
| HF, Vehicle Mount, High-Power                                      |            |                        |                  |                         |             |                        |              |                   |             | 1         |                      |                     |                |             | 1     |
| Radio Relay, VHF/UHF   |            |                        | 2                |                         |             |                        | 1            |                   |             | 2         |                      |                     |                |             | 5     |
| Warning Receiver   | 1          | 3                      | 1                | 2                       |             | 3                      | 1            | 1                 |             | 3         |                      |                     |                |             | 15    |
| <b>MISCELLANEOUS</b>   |            |                        |                  |                         |             |                        |              |                   |             |           |                      |                     |                |             |       |
| Rangefinder, Laser, SAGE GLOSS                                     |            |                        |                  | 4                       |             |                        |              |                   |             |           |                      |                     |                |             | 4     |
| Rangefinder, Steroscopic   |            | 3                      |                  |                         | 1           |                        | 3            |                   |             |           |                      |                     |                |             | 7     |
| Periscopic Aiming Circle   |            | 3                      |                  |                         | 1           |                        |              |                   |             |           |                      |                     |                |             | 4     |
| Collimator   |            | 18                     |                  |                         | 6           |                        |              |                   |             |           |                      |                     |                |             | 24    |
| Motorcycle   |            |                        |                  |                         |             |                        |              | 9                 |             | 3         |                      |                     |                |             | 12    |

**FOOTNOTE:**

\* Some separate mechanized infantry brigades (APC) may have only an ATGM battery (see p. 3-27).

Mechanized Infantry Brigade (IFV) (Separate)

| Principal Items of Equipment                           | Brigade HQ | Mech Inf Bn (IFV) (3x) | Separate Tank Bn | SP Howitzer Bn (122-mm) | Mortar Btry | SP AA Gun Btry (23-mm) | Antitank Bn* | Reconnaissance Co | Engineer Co | Signal Co | Chemical Defense Plt | Material Support Co | Maintenance Co | Medical Plt | TOTAL |
|--|------------|------------------------|------------------|-------------------------|-------------|------------------------|--------------|-------------------|-------------|-----------|----------------------|---------------------|----------------|-------------|-------|
| <b>ARMORED VEHICLES</b>                                |            |                        |                  |                         |             |                        |              |                   |             |           |                      |                     |                |             |       |
| ACV, BTR-60PBK/70K/80K                                 | 1          |                        |                  |                         |             |                        |              |                   |             |           |                      |                     |                |             | 1     |
| APC, BTR-60/70/80                                      | 1          |                        |                  |                         |             |                        |              |                   |             |           |                      |                     |                |             | 1     |
| APC, BTR-60PA (FAC)                                    | 1          |                        |                  |                         |             |                        |              |                   |             |           |                      |                     |                |             | 1     |
| APC, BTR-60 (PU-12)                                    |            |                        |                  |                         |             | 1                      |              |                   |             |           |                      |                     |                |             | 1     |
| ACV, BTR (R-145BM)                                     |            | 3                      | 2                |                         |             |                        | 1            |                   | 1           | 8         |                      |                     |                |             | 15    |
| ACV, BMP-1K/2K   |            | 6                      | 1                |                         |             |                        |              |                   |             |           |                      |                     |                |             | 7     |
| IFV, BMP-1/2   |            | 117                    |                  |                         |             |                        |              | 2                 |             |           |                      |                     |                |             | 119   |
| ACV, BRM-1K  |            |                        |                  |                         |             |                        |              | 2                 |             |           |                      |                     |                |             | 2     |
| Mobile Recon Post, PRP-3/4**                           |            |                        |                  | 1                       |             |                        | 1            |                   |             |           |                      |                     |                |             | 2     |
| ASC, BRDM-2  |            |                        |                  |                         |             |                        |              | 4                 |             |           |                      |                     |                |             | 4     |
| ACV, BRDM-2U   |            |                        |                  |                         |             |                        | 4            |                   |             |           |                      |                     |                |             | 4     |
| Chem Recon Vehicle, BRDM-2RK/RKHM                      |            |                        |                  |                         |             |                        |              |                   |             | 3         |                      |                     |                |             | 3     |
| Prime Mover, MT-LBT                                    |            |                        |                  |                         |             |                        | 14           |                   |             |           |                      |                     |                |             | 14    |
| ACRV, 1V13/1V13M/1V22 (Btry FDC)                       |            |                        |                  | 3                       |             |                        |              |                   |             |           |                      |                     |                |             | 3     |
| ACRV, 1V14/1V14M/1V23 (Btry COP)                       |            |                        |                  | 3                       |             |                        |              |                   |             |           |                      |                     |                |             | 3     |
| ACRV, 1V15/1V15M/1V24 (Bn COP)                         |            |                        |                  | 1                       |             |                        |              |                   |             |           |                      |                     |                |             | 1     |
| ACRV, 1V16/1V16M/1V25 (Bn FDC)                         |            |                        |                  | 1                       |             |                        |              |                   |             |           |                      |                     |                |             | 1     |
| Medium Tank, T-55K/62K                                 |            |                        | 1                |                         |             |                        |              |                   |             |           |                      |                     |                |             | 1     |
| Medium Tank, T-55/62                                   |            |                        | 30               |                         |             |                        |              |                   |             |           |                      |                     |                |             | 30    |
| Armored Recovery Vehicle                               |            |                        | 2                |                         |             |                        |              |                   |             |           |                      |                     | 3              |             | 5     |
| Armored Maintenance Vehicle, MTP                       |            |                        |                  |                         |             |                        |              |                   |             |           |                      |                     | 3              |             | 3     |
| <b>WEAPONS</b>   |            |                        |                  |                         |             |                        |              |                   |             |           |                      |                     |                |             |       |
| 30-mm Auto Grenade Lchr, AGS-17                        |            | 18                     |                  |                         |             |                        |              |                   |             |           |                      |                     |                |             | 18    |
| 120-mm Mortar, M1943/2S12 or<br>82-mm Mortar M1937/2B9 |            | 18                     |                  |                         | 6           |                        |              |                   |             |           |                      |                     |                |             | 24    |
| 122-mm SP Howitzer, 2S1                                |            |                        |                  | 18                      |             |                        |              |                   |             |           |                      |                     |                |             | 18    |
| 100-mm AT Gun, T-12/MT-12                              |            |                        |                  |                         |             |                        | 12           |                   |             |           |                      |                     |                |             | 12    |
| ATGM Manpack, AT-4/SPIGOT                              |            | 18                     |                  |                         |             |                        |              |                   |             |           |                      |                     |                |             | 18    |
| ATGM Vehicle, w/AT-3/5                                 |            |                        |                  |                         |             |                        | 9            |                   |             |           |                      |                     |                |             | 9     |
| 23-mm SP AA Gun, ZSU-23-4***                           |            |                        |                  |                         |             | 8                      |              |                   |             |           |                      |                     |                |             | 8     |
| SAM, Shoulder-Fired                                    | 3          | 27                     |                  | 18                      |             |                        |              |                   |             |           |                      |                     |                |             | 48    |
| Flamethrower, LPO/RPO                                  |            | 27                     | 2                |                         |             |                        |              | 4                 |             |           |                      |                     |                |             | 33    |
| <b>ENGINEER EQUIPMENT</b>                              |            |                        |                  |                         |             |                        |              |                   |             |           |                      |                     |                |             |       |
| Bridge, Tank-Launched                                  |            |                        | 1                |                         |             |                        |              |                   | 1           |           |                      |                     |                |             | 2     |
| Bridge, Truck-Launched                                 |            |                        |                  |                         |             |                        |              |                   | 4           |           |                      |                     |                |             | 4     |
| Ditching Machine, BTM/MDK                              |            |                        | 1                |                         |             |                        |              |                   |             |           |                      |                     |                |             | 1     |
| Ditching Machine, PZM/TMK                              |            |                        |                  |                         |             |                        |              |                   | 4           |           |                      |                     |                |             | 4     |
| Route-Clearing Vehicle, BAT/PKT                        |            |                        | 1                |                         |             |                        |              |                   | 1           |           |                      |                     |                |             | 2     |
| Armored Engineer Tractor, IMR                          |            |                        |                  |                         |             |                        |              |                   | 1           |           |                      |                     |                |             | 1     |
| Minelayer, GMZ   |            |                        |                  |                         |             |                        |              |                   | 3           |           |                      |                     |                |             | 3     |
| Mineclearing Plow                                      |            |                        | 9                |                         |             |                        |              |                   |             |           |                      |                     |                |             | 9     |
| Mine Roller-Plow                                       |            |                        | 3                |                         |             |                        |              |                   |             |           |                      |                     |                |             | 3     |
| Mine Detector, DIM                                     |            |                        |                  |                         |             |                        |              |                   | 1           |           |                      |                     |                |             | 1     |
| Truck, Water Purification                              |            |                        |                  |                         |             |                        |              |                   | 1           |           |                      |                     |                |             | 1     |

FOOTNOTES:

\* Some separate mechanized infantry brigades (IFV) may have only an ATGM battery (see p. 3-27).

\*\* This vehicle includes the SMALL FRED or TALL MIKE battlefield surveillance radar.

\*\*\* This vehicle includes the GUN DISH fire control radar.

(continued)

## Mechanized Infantry Brigade (IFV) (Separate) (continued)

| Principal Items of Equipment                                       | Brigade HQ | Mech Inf Bn (IFV) (3x) | Separate Tank Bn | SP Howitzer Bn (122-mm) | Mortar Btry | SP AA Gun Btry (23-mm) | Antitank Bn* | Reconnaissance Co | Engineer Co | Signal Co | Chemical Defense Plt | Material Support Co | Maintenance Co | Medical Plt | TOTAL |
|--|------------|------------------------|------------------|-------------------------|-------------|------------------------|--------------|-------------------|-------------|-----------|----------------------|---------------------|----------------|-------------|-------|
| <b>TRUCKS</b>  |            |                        |                  |                         |             |                        |              |                   |             |           |                      |                     |                |             |       |
| Truck, Utility   | 3          | 12                     | 1                |                         | 1           |                        | 3            |                   | 4           | 5         |                      | 2                   | 1              |             | 32    |
| Truck, Light   |            | 39                     | 1                | 4                       | 7           | 1                      | 4            |                   |             | 3         |                      | 4                   |                | 1           | 64    |
| Truck, Medium  | 1          | 12                     | 13               | 14                      |             | 4                      | 12           |                   | 9           |           |                      | 45                  | 2              | 2           | 114   |
| Truck, Crane   |            |                        | 1                |                         |             |                        |              |                   | 1           |           |                      |                     |                |             | 2     |
| Truck, Crane Shovel  |            |                        |                  |                         |             |                        |              |                   | 1           |           |                      |                     |                |             | 1     |
| Truck, Decon, ARS-12U/14   |            |                        |                  |                         |             |                        |              |                   |             |           | 3                    |                     |                |             | 3     |
| Truck, Decon, DDA-53/66  |            |                        |                  |                         |             |                        |              |                   |             |           | 1                    |                     |                | 1           | 2     |
| Truck, Dump  |            |                        |                  |                         |             |                        |              |                   | 2           |           |                      |                     |                |             | 2     |
| Truck, POL (5,000-L)   |            | 6                      | 4                | 2                       |             |                        | 3            |                   |             |           |                      | 15                  |                |             | 30    |
| Truck, Water (2,000-L)   |            |                        |                  |                         |             |                        |              |                   |             |           | 2                    | 4                   |                |             | 6     |
| Van, Command   | 3          |                        |                  |                         |             |                        |              |                   |             |           |                      |                     |                |             | 3     |
| Van, Hospital  |            |                        |                  |                         |             |                        |              |                   |             |           |                      |                     |                | 1           | 1     |
| Van, Kitchen   |            | 3                      | 1                |                         |             |                        |              |                   |             |           |                      |                     |                |             | 4     |
| Van, Maintenance   |            | 3                      | 1                | 2                       |             |                        | 2            |                   | 1           |           |                      | 1                   | 9              |             | 19    |
| Van, Signal  |            | 3                      | 2                | 4                       |             |                        | 2            |                   |             | 2         |                      |                     |                |             | 13    |
| Ambulance  |            | 3                      | 1                | 1                       |             |                        | 1            |                   |             |           |                      |                     |                | 4           | 10    |
| <b>TRAILERS</b>  |            |                        |                  |                         |             |                        |              |                   |             |           |                      |                     |                |             |       |
| Trailer, Cargo, 1-Axle   |            | 6                      | 1                |                         |             |                        |              |                   | 6           |           |                      |                     |                |             | 13    |
| Trailer, Cargo, 2-Axle   |            |                        | 7                | 16                      |             |                        | 10           |                   | 2           |           |                      | 30                  |                |             | 65    |
| Trailer, Generator   |            | 3                      | 3                | 2                       |             | 2                      | 1            |                   |             | 1         |                      | 1                   | 6              |             | 19    |
| Trailer, Kitchen   |            | 9                      |                  | 3                       |             |                        | 1            |                   | 1           |           |                      | 2                   | 3              | 1           | 20    |
| Trailer, POL (4,200-L)   |            | 9                      | 4                | 2                       |             |                        | 3            |                   |             |           |                      | 15                  |                |             | 33    |
| Trailer, Water (900-/1,200-L)                                      |            | 3                      | 1                | 1                       |             |                        | 1            |                   | 1           |           | 2                    | 1                   |                | 1           | 11    |
| <b>RADARS</b>  |            |                        |                  |                         |             |                        |              |                   |             |           |                      |                     |                |             |       |
| Radar, Battlefield Surveillance, Man-Portable, PSNR-1 or TALL MIKE |            |                        |                  |                         |             |                        | 3            | 1                 |             |           |                      |                     |                |             | 4     |
| <b>RADIOS</b>  |            |                        |                  |                         |             |                        |              |                   |             |           |                      |                     |                |             |       |
| VHF, Manpack, Low-Power  | 3          | 48                     | 5                | 10                      | 5           |                        | 10           | 4                 | 4           | 7         |                      | 1                   | 1              | 1           | 99    |
| VHF, Portable, Low-Power   |            | 66                     |                  |                         |             | 1                      |              | 5                 |             |           |                      |                     |                |             | 72    |
| VHF, Portable, Very-Low-Power                                      |            | 12                     |                  |                         |             |                        |              |                   |             |           |                      |                     |                |             | 12    |
| VHF, Vehicle Mount, Medium-Power                                   | 3          | 132                    | 37               | 27                      | 1           | 9                      | 28           | 8                 | 6           | 8         | 3                    |                     | 6              |             | 268   |
| HF, Manpack, Low-Power   |            |                        | 2                |                         |             |                        |              |                   |             | 2         | 1                    |                     |                |             | 5     |
| HF, Vehicle Mount, Medium-Power                                    | 1          | 6                      | 6                |                         |             |                        | 1            | 1                 | 1           | 2         |                      |                     |                |             | 18    |
| HF/VHF, Vehicle Mount, Med-Power                                   |            | 3                      |                  | 4                       |             |                        | 3            |                   |             | 2         |                      |                     |                |             | 12    |
| HF/VHF, Vehicle Mount, High-Power                                  |            |                        |                  |                         |             |                        |              |                   |             | 2         |                      |                     |                |             | 2     |
| HF, Vehicle Mount, High-Power                                      |            |                        |                  |                         |             |                        |              |                   |             | 1         |                      |                     |                |             | 1     |
| Radio Relay, VHF/UHF   |            |                        | 2                |                         |             |                        | 1            |                   |             | 2         |                      |                     |                |             | 5     |
| Warning Receiver   | 1          | 3                      | 1                | 2                       |             | 3                      | 1            | 1                 |             | 3         |                      |                     |                |             | 15    |
| <b>MISCELLANEOUS</b>   |            |                        |                  |                         |             |                        |              |                   |             |           |                      |                     |                |             |       |
| Rangefinder, Laser, SAGE GLOSS                                     |            |                        |                  | 4                       |             |                        |              |                   |             |           |                      |                     |                |             | 4     |
| Rangefinder, Steroscopic   |            |                        |                  |                         | 1           |                        | 3            |                   |             |           |                      |                     |                |             | 4     |
| Periscopic Aiming Circle   |            |                        |                  |                         | 1           |                        |              |                   |             |           |                      |                     |                |             | 1     |
| Collimator   |            |                        |                  |                         | 6           |                        |              |                   |             |           |                      |                     |                |             | 6     |
| Motorcycle   |            |                        |                  |                         |             |                        |              | 3                 |             | 3         |                      |                     |                |             | 6     |

**FOOTNOTE:**

\* Some separate mechanized infantry brigades (IFV) may have only an ATGM battery (see p. 3-27).

Mechanized Infantry Brigade (Divisional)

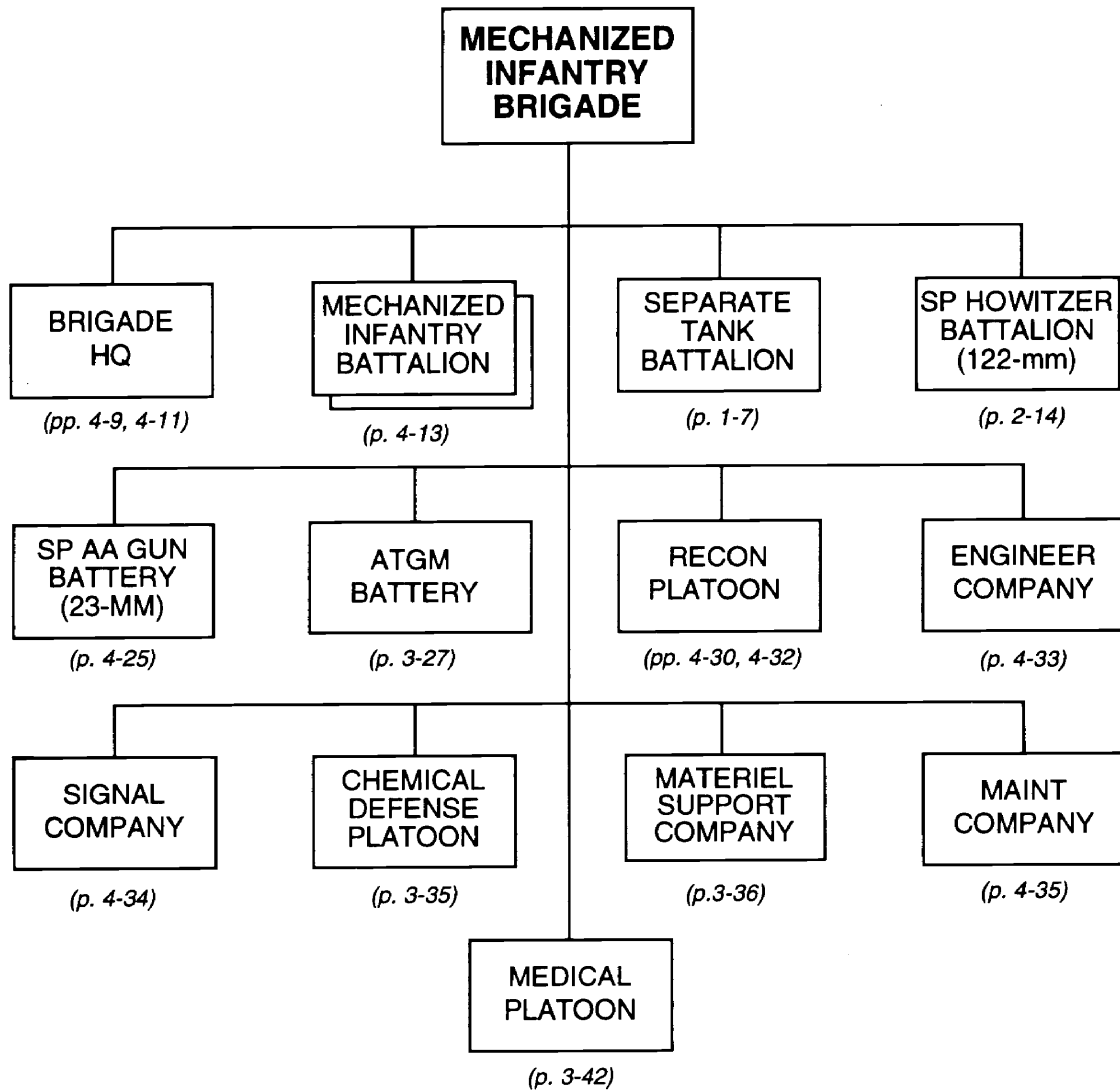

NOTES:

1. A mechanized infantry brigade normally has all mechanized infantry battalions of the same type (APC-equipped or IFV-equipped). In rare cases, however, a mix of the two battalion types may occur.

2. The principal items of equipment that follow depict normal brigade structures. These have either all APC-equipped mechanized infantry battalions or all IFV-equipped battalions.

(continued)



## Mechanized Infantry Brigade (APC) (Divisional)

| Principal Items of Equipment                           | Brigade HQ | Mech Inf Bn (APC) (2x) | Separate Tank Bn | SP Howitzer Bn (122-mm) | SP AA Gun Btry (23-mm) | ATGM Btry | Reconnaissance Plt | Engineer Co | Signal Co | Chemical Defense Plt | Material Support Co | Maintenance Co | Medical Plt | TOTAL |
|--|------------|------------------------|------------------|-------------------------|------------------------|-----------|--------------------|-------------|-----------|----------------------|---------------------|----------------|-------------|-------|
| <b>ARMORED VEHICLES</b>                                |            |                        |                  |                         |                        |           |                    |             |           |                      |                     |                |             |       |
| ACV, BTR-60PBK/70K/80K                                 | 1          | 4                      |                  |                         |                        |           |                    |             |           |                      |                     |                |             | 5     |
| APC, BTR-60/70/80                                      | 1          | 82                     |                  |                         |                        |           |                    |             |           |                      |                     |                |             | 83    |
| APC, BTR-60PA (FAC)                                    | 1          |                        |                  |                         |                        |           |                    |             |           |                      |                     |                |             | 1     |
| APC, BTR-60 (PU-12)                                    |            |                        |                  |                         | 1                      |           |                    |             |           |                      |                     |                |             | 1     |
| ACV, BTR (R-145BM)                                     |            | 2                      | 2                |                         |                        |           |                    | 1           | 8         |                      |                     |                |             | 13    |
| ACV, BMP-1K/2K   |            |                        | 1                |                         |                        |           |                    |             |           |                      |                     |                |             | 1     |
| Mobile Recon Post, PRP-3/4*                            |            |                        |                  | 1                       |                        |           |                    |             |           |                      |                     |                |             | 1     |
| ASC, BRDM-2  |            |                        |                  |                         |                        |           | 3                  |             |           |                      |                     |                |             | 3     |
| ACV, BRDM-2U   |            |                        |                  |                         |                        | 4         | 1                  |             |           |                      |                     |                |             | 5     |
| Chem Recon Vehicle, BRDM-2RKh/RKhM                     |            |                        |                  |                         |                        |           |                    |             |           | 3                    |                     |                |             | 3     |
| ACRV, 1V13/1V13M/1V22 (Btry FDC)                       |            |                        |                  | 3                       |                        |           |                    |             |           |                      |                     |                |             | 3     |
| ACRV, 1V14/1V14M/1V23 (Btry COP)                       |            |                        |                  | 3                       |                        |           |                    |             |           |                      |                     |                |             | 3     |
| ACRV, 1V15/1V15M/1V24 (Bn COP)                         |            |                        |                  | 1                       |                        |           |                    |             |           |                      |                     |                |             | 1     |
| ACRV, 1V16/1V16M/1V25 (Bn FDC)                         |            |                        |                  | 1                       |                        |           |                    |             |           |                      |                     |                |             | 1     |
| Medium Tank, T-55K/62K                                 |            |                        | 1                |                         |                        |           |                    |             |           |                      |                     |                |             | 1     |
| Medium Tank, T-55/62                                   |            |                        | 30               |                         |                        |           |                    |             |           |                      |                     |                |             | 30    |
| Armored Recovery Vehicle                               |            |                        | 2                |                         |                        |           |                    |             |           |                      |                     | 3              |             | 5     |
| <b>WEAPONS</b>   |            |                        |                  |                         |                        |           |                    |             |           |                      |                     |                |             |       |
| 30-mm Auto Grenade Lchr, AGS-17                        |            | 12                     |                  |                         |                        |           |                    |             |           |                      |                     |                |             | 12    |
| 73-mm Recoilless Gun, SPG-9                            |            | 6                      |                  |                         |                        |           |                    |             |           |                      |                     |                |             | 6     |
| 120-mm Mortar, M1943/2S12 or<br>82-mm Mortar M1937/2B9 |            | 12                     |                  |                         |                        |           |                    |             |           |                      |                     |                |             | 12    |
| 122-mm SP Howitzer, 2S1                                |            |                        |                  | 18                      |                        |           |                    |             |           |                      |                     |                |             | 18    |
| ATGM Manpack, AT-4/SPIGOT                              |            | 12                     |                  |                         |                        |           |                    |             |           |                      |                     |                |             | 12    |
| ATGM Vehicle, w/AT-3/5                                 |            |                        |                  |                         |                        | 12        |                    |             |           |                      |                     |                |             | 12    |
| 23-mm SP AA Gun, ZSU-23-4**                            |            |                        |                  |                         | 8                      |           |                    |             |           |                      |                     |                |             | 8     |
| SAM, Shoulder-Fired                                    | 3          | 18                     |                  | 18                      |                        |           |                    |             |           |                      |                     |                |             | 39    |
| Flamethrower, LPO/RPO                                  |            | 18                     | 2                |                         |                        |           |                    | 4           |           |                      |                     |                |             | 24    |
| <b>ENGINEER EQUIPMENT</b>                              |            |                        |                  |                         |                        |           |                    |             |           |                      |                     |                |             |       |
| Bridge, Tank-Launched                                  |            |                        | 1                |                         |                        |           |                    | 1           |           |                      |                     |                |             | 2     |
| Bridge, Truck-Launched                                 |            |                        |                  |                         |                        |           |                    | 4           |           |                      |                     |                |             | 4     |
| Ditching Machine, BTM/MDK                              |            |                        | 1                |                         |                        |           |                    |             |           |                      |                     |                |             | 1     |
| Ditching Machine, PZM/TMK                              |            |                        |                  |                         |                        |           |                    | 4           |           |                      |                     |                |             | 4     |
| Route-Clearing Vehicle, BAT/PKT                        |            |                        | 1                |                         |                        |           |                    | 1           |           |                      |                     |                |             | 2     |
| Armored Engineer Tractor, IMR                          |            |                        |                  |                         |                        |           |                    | 1           |           |                      |                     |                |             | 1     |
| Minelayer, GMZ   |            |                        |                  |                         |                        |           |                    | 3           |           |                      |                     |                |             | 3     |
| Mineclearing Plow                                      |            |                        | 9                |                         |                        |           |                    |             |           |                      |                     |                |             | 9     |
| Mine Roller-Plow                                       |            |                        | 3                |                         |                        |           |                    |             |           |                      |                     |                |             | 3     |
| Mine Detector, DIM                                     |            |                        |                  |                         |                        |           |                    | 1           |           |                      |                     |                |             | 1     |
| Truck, Water Purification                              |            |                        |                  |                         |                        |           |                    | 1           |           |                      |                     |                |             | 1     |

## FOOTNOTES:

\* This vehicle includes the SMALL FRED or TALL MIKE battlefield surveillance radar.

\*\* This vehicle includes the GUN DISH fire control radar.

(continued)

**Mechanized Infantry Brigade (APC) (Divisional)**  
**(continued)**

| <i>Principal Items of Equipment</i>                                   | <i>Brigade HQ</i> | <i>Mech Inf Bn (APC) (2x)</i> | <i>Separate Tank Bn</i> | <i>SP Howitzer Bn (122-mm)</i> | <i>SP AA Gun Btry (23-mm)</i> | <i>ATGM Btry</i> | <i>Reconnaissance Plt</i> | <i>Engineer Co</i> | <i>Signal Co</i> | <i>Chemical Defense Plt</i> | <i>Material Support Co</i> | <i>Maintenance Co</i> | <i>Medical Plt</i> | <i>TOTAL</i> |
|---|-------------------|-------------------------------|-------------------------|--------------------------------|-------------------------------|------------------|---------------------------|--------------------|------------------|-----------------------------|----------------------------|-----------------------|--------------------|--------------|
| <b>TRUCKS</b>   |                   |                               |                         |                                |                               |                  |                           |                    |                  |                             |                            |                       |                    |              |
| Truck, Utility  | 3                 | 8                             | 1                       |                                |                               |                  |                           | 4                  | 5                |                             | 2                          | 1                     |                    | 24           |
| Truck, Light  |                   | 26                            | 1                       | 4                              | 1                             |                  |                           |                    | 3                |                             | 4                          |                       | 1                  | 40           |
| Truck, Medium   | 1                 | 8                             | 13                      | 14                             | 4                             | 3                |                           | 9                  |                  |                             | 30                         | 2                     | 2                  | 86           |
| Truck, Crane  |                   |                               | 1                       |                                |                               |                  |                           | 1                  |                  |                             |                            |                       |                    | 2            |
| Truck, Crane Shovel   |                   |                               |                         |                                |                               |                  |                           | 1                  |                  |                             |                            |                       |                    | 1            |
| Truck, Decon, ARS-12U/14  |                   |                               |                         |                                |                               |                  |                           |                    |                  | 3                           |                            |                       |                    | 3            |
| Truck, Decon, DDA-53/66   |                   |                               |                         |                                |                               |                  |                           |                    |                  | 1                           |                            |                       | 1                  | 2            |
| Truck, Dump   |                   |                               |                         |                                |                               |                  |                           | 2                  |                  |                             |                            |                       |                    | 2            |
| Truck, POL (5,000-L)  |                   | 6                             | 4                       | 2                              |                               |                  |                           |                    |                  |                             | 10                         |                       |                    | 22           |
| Truck, Water (2,000-L)  |                   |                               |                         |                                |                               |                  |                           |                    |                  | 2                           | 3                          |                       |                    | 5            |
| Van, Command  | 3                 |                               |                         |                                |                               |                  |                           |                    |                  |                             |                            |                       |                    | 3            |
| Van, Hospital   |                   |                               |                         |                                |                               |                  |                           |                    |                  |                             |                            |                       | 1                  | 1            |
| Van, Kitchen  |                   | 2                             | 1                       |                                |                               |                  |                           |                    |                  |                             |                            |                       |                    | 3            |
| Van, Maintenance  |                   | 2                             | 1                       | 2                              |                               |                  |                           | 1                  |                  |                             | 1                          | 9                     |                    | 16           |
| Van, Signal   |                   | 2                             | 2                       | 4                              |                               |                  |                           |                    | 2                |                             |                            |                       |                    | 10           |
| Ambulance   |                   | 2                             | 1                       | 1                              |                               |                  |                           |                    |                  |                             |                            |                       | 4                  | 8            |
| <b>TRAILERS</b>   |                   |                               |                         |                                |                               |                  |                           |                    |                  |                             |                            |                       |                    |              |
| Trailer, Cargo, 1-Axle  |                   | 4                             | 1                       |                                |                               |                  |                           | 6                  |                  |                             |                            |                       |                    | 11           |
| Trailer, Cargo, 2-Axle  |                   |                               | 7                       | 16                             |                               |                  |                           | 2                  |                  |                             | 20                         |                       |                    | 45           |
| Trailer, Generator  |                   | 2                             | 3                       | 2                              | 2                             |                  |                           |                    | 1                |                             | 1                          | 6                     |                    | 17           |
| Trailer, Kitchen  |                   | 6                             |                         | 3                              |                               |                  |                           | 1                  |                  |                             | 2                          | 3                     | 1                  | 16           |
| Trailer, POL (4,200-L)  |                   | 2                             | 4                       | 2                              |                               |                  |                           |                    |                  |                             | 10                         |                       |                    | 18           |
| Trailer, POL (1,200-L)  |                   | 2                             |                         |                                |                               |                  |                           |                    |                  |                             |                            |                       |                    | 2            |
| Trailer, Water (900-/1,200-L)   |                   | 2                             | 1                       | 1                              |                               |                  |                           | 1                  |                  | 2                           | 1                          |                       | 1                  | 9            |
| <b>RADARS</b>   |                   |                               |                         |                                |                               |                  |                           |                    |                  |                             |                            |                       |                    |              |
| Radar, Battlefield Surveillance,<br>Man-Portable, PSNR-1 or TALL MIKE |                   |                               |                         |                                |                               | 1                | 1                         |                    |                  |                             |                            |                       |                    | 2            |
| <b>RADIOS</b>   |                   |                               |                         |                                |                               |                  |                           |                    |                  |                             |                            |                       |                    |              |
| VHF, Manpack, Low-Power   | 3                 | 32                            | 5                       | 10                             |                               | 4                |                           | 4                  | 7                |                             | 1                          | 1                     | 1                  | 68           |
| VHF, Portable, Low-Power  |                   | 50                            |                         |                                | 1                             |                  | 4                         |                    |                  |                             |                            |                       |                    | 55           |
| VHF, Portable, Very-Low-Power   |                   | 8                             |                         |                                |                               |                  |                           |                    |                  |                             |                            |                       |                    | 8            |
| VHF, Vehicle Mount, Medium-Power                                      | 3                 | 92                            | 37                      | 27                             | 9                             | 16               | 4                         | 6                  | 8                | 3                           |                            | 3                     |                    | 208          |
| HF, Manpack, Low-Power  |                   |                               | 2                       |                                |                               |                  |                           |                    | 2                | 1                           |                            |                       |                    | 5            |
| HF, Vehicle Mount, Medium-Power                                       | 1                 | 4                             | 6                       |                                |                               |                  | 1                         | 1                  | 2                |                             |                            |                       |                    | 15           |
| HF/VHF, Vehicle Mount, Med-Power                                      |                   | 2                             |                         | 4                              |                               |                  |                           |                    | 2                |                             |                            |                       |                    | 8            |
| HF/VHF, Vehicle Mount, High-Power                                     |                   |                               |                         |                                |                               |                  |                           |                    | 2                |                             |                            |                       |                    | 2            |
| HF, Vehicle Mount, High-Power   |                   |                               |                         |                                |                               |                  |                           |                    | 1                |                             |                            |                       |                    | 1            |
| Radio Relay, VHF/UHF  |                   |                               | 2                       |                                |                               |                  |                           |                    | 2                |                             |                            |                       |                    | 4            |
| Warning Receiver  | 1                 | 2                             | 1                       | 2                              | 3                             |                  |                           |                    | 3                |                             |                            |                       |                    | 12           |
| <b>MISCELLANEOUS</b>  |                   |                               |                         |                                |                               |                  |                           |                    |                  |                             |                            |                       |                    |              |
| Rangefinder, Laser, SAGE GLOSS  |                   |                               |                         | 4                              |                               |                  |                           |                    |                  |                             |                            |                       |                    | 4            |
| Rangefinder, Stereoscopic   |                   | 2                             |                         |                                |                               | 1                |                           |                    |                  |                             |                            |                       |                    | 3            |
| Periscopic Aiming Circle  |                   | 2                             |                         |                                |                               |                  |                           |                    |                  |                             |                            |                       |                    | 2            |
| Collimator  |                   | 12                            |                         |                                |                               |                  |                           |                    |                  |                             |                            |                       |                    | 12           |
| Motorcycle  |                   |                               |                         |                                |                               |                  |                           |                    | 3                |                             |                            |                       |                    | 3            |

## Mechanized Infantry Brigade (IFV) (Divisional)

| Principal Items of Equipment                           | Brigade HQ | Mech Inf Bn (IFV) (2x) | Separate Tank Bn | SP Howitzer Bn (122-mm) | SP AA Gun Btry (23-mm) | ATGM Btry | Reconnaissance Plt | Engineer Co | Signal Co | Chemical Defense Plt | Material Support Co | Maintenance Co | Medical Plt | TOTAL |
|--|------------|------------------------|------------------|-------------------------|------------------------|-----------|--------------------|-------------|-----------|----------------------|---------------------|----------------|-------------|-------|
| <b>ARMORED VEHICLES</b>                                |            |                        |                  |                         |                        |           |                    |             |           |                      |                     |                |             |       |
| ACV, BTR-60PBK/70K/80K                                 | 1          |                        |                  |                         |                        |           |                    |             |           |                      |                     |                |             | 1     |
| APC, BTR-60/70/80                                      | 1          |                        |                  |                         |                        |           |                    |             |           |                      |                     |                |             | 1     |
| APC, BTR-60PA (FAC)                                    | 1          |                        |                  |                         |                        |           |                    |             |           |                      |                     |                |             | 1     |
| APC, BTR-60 (PU-12)                                    |            |                        |                  |                         | 1                      |           |                    |             |           |                      |                     |                |             | 1     |
| ACV, BTR (R-145BM)                                     |            | 2                      | 2                |                         |                        |           |                    | 1           | 8         |                      |                     |                |             | 13    |
| ACV, BMP-1K/2K   |            | 4                      | 1                |                         |                        |           |                    |             |           |                      |                     |                |             | 5     |
| IFV, BMP-1/2   |            | 78                     |                  |                         |                        |           | 2                  |             |           |                      |                     |                |             | 80    |
| ACV, BRM-1K*   |            |                        |                  |                         |                        |           | 1                  |             |           |                      |                     |                |             | 1     |
| Mobile Recon Post, PRP-3/4**                           |            |                        |                  | 1                       |                        |           |                    |             |           |                      |                     |                |             | 1     |
| ACV, BRDM-2U   |            |                        |                  |                         |                        | 4         |                    |             |           |                      |                     |                |             | 4     |
| Chem Recon Vehicle, BRDM-2RKh/RKhM                     |            |                        |                  |                         |                        |           |                    |             |           | 3                    |                     |                |             | 3     |
| ACRV, 1V13/1V13M/1V22 (Btry FDC)                       |            |                        |                  | 3                       |                        |           |                    |             |           |                      |                     |                |             | 3     |
| ACRV, 1V14/1V14M/1V23 (Btry COP)                       |            |                        |                  | 3                       |                        |           |                    |             |           |                      |                     |                |             | 3     |
| ACRV, 1V15/1V15M/1V24 (Bn COP)                         |            |                        |                  | 1                       |                        |           |                    |             |           |                      |                     |                |             | 1     |
| ACRV, 1V16/1V16M/1V25 (Bn FDC)                         |            |                        |                  | 1                       |                        |           |                    |             |           |                      |                     |                |             | 1     |
| Medium Tank, T-55K/62K                                 |            |                        | 1                |                         |                        |           |                    |             |           |                      |                     |                |             | 1     |
| Medium Tank, T-55/62                                   |            |                        | 30               |                         |                        |           |                    |             |           |                      |                     |                |             | 30    |
| Armored Recovery Vehicle                               |            |                        | 2                |                         |                        |           |                    |             |           |                      |                     | 3              |             | 5     |
| Armored Maintenance Vehicle, MTP                       |            |                        |                  |                         |                        |           |                    |             |           |                      |                     | 3              |             | 3     |
| <b>WEAPONS</b>   |            |                        |                  |                         |                        |           |                    |             |           |                      |                     |                |             |       |
| 30-mm Auto Grenade Lchr, AGS-17                        |            | 12                     |                  |                         |                        |           |                    |             |           |                      |                     |                |             | 12    |
| 120-mm Mortar, M1943/2S12 or<br>82-mm Mortar M1937/2B9 |            | 12                     |                  |                         |                        |           |                    |             |           |                      |                     |                |             | 12    |
| 122-mm SP Howitzer, 2S1                                |            |                        |                  | 18                      |                        |           |                    |             |           |                      |                     |                |             | 18    |
| ATGM Manpack, AT-4/SPIGOT                              |            | 12                     |                  |                         |                        |           |                    |             |           |                      |                     |                |             | 12    |
| ATGM Vehicle, w/AT-3/5                                 |            |                        |                  |                         |                        | 12        |                    |             |           |                      |                     |                |             | 12    |
| 23-mm SP AA Gun, ZSU-23-4***                           |            |                        |                  |                         | 8                      |           |                    |             |           |                      |                     |                |             | 8     |
| SAM, Shoulder-Fired                                    | 3          | 18                     |                  | 18                      |                        |           |                    |             |           |                      |                     |                |             | 39    |
| Flamethrower, LPO/RPO                                  |            | 18                     | 2                |                         |                        |           |                    | 4           |           |                      |                     |                |             | 24    |
| <b>ENGINEER EQUIPMENT</b>                              |            |                        |                  |                         |                        |           |                    |             |           |                      |                     |                |             |       |
| Bridge, Tank-Launched                                  |            |                        | 1                |                         |                        |           |                    | 1           |           |                      |                     |                |             | 2     |
| Bridge, Truck-Launched                                 |            |                        |                  |                         |                        |           |                    | 4           |           |                      |                     |                |             | 4     |
| Ditching Machine, BTM/MDK                              |            |                        | 1                |                         |                        |           |                    |             |           |                      |                     |                |             | 1     |
| Ditching Machine, PZM/TMK                              |            |                        |                  |                         |                        |           |                    | 4           |           |                      |                     |                |             | 4     |
| Route-Clearing Vehicle, BAT/PKT                        |            |                        | 1                |                         |                        |           |                    | 1           |           |                      |                     |                |             | 2     |
| Armored Engineer Tractor, IMR                          |            |                        |                  |                         |                        |           |                    | 1           |           |                      |                     |                |             | 1     |
| Minelayer, GMZ   |            |                        |                  |                         |                        |           |                    | 3           |           |                      |                     |                |             | 3     |
| Mineclearing Plow                                      |            |                        | 9                |                         |                        |           |                    |             |           |                      |                     |                |             | 9     |
| Mine Roller-Plow                                       |            |                        | 3                |                         |                        |           |                    |             |           |                      |                     |                |             | 3     |
| Mine Detector, DIM                                     |            |                        |                  |                         |                        |           |                    | 1           |           |                      |                     |                |             | 1     |
| Truck, Water Purification                              |            |                        |                  |                         |                        |           |                    | 1           |           |                      |                     |                |             | 1     |

## FOOTNOTES:

- \* This vehicle includes the TALL MIKE battlefield surveillance radar.
- \*\* This vehicle includes the SMALL FRED or TALL MIKE battlefield surveillance radar.
- \*\*\* This vehicle includes the GUN DISH fire control radar.

(continued)

Mechanized Infantry Brigade (IFV) (Divisional)  
(continued)

| Principal Items of Equipment                                       | Brigade HQ | Mech Inf Bn (IFV) (2x) | Separate Tank Bn | SP Howitzer Bn (122-mm) | SP AA Gun Btry (23-mm) | ATGM Btry | Reconnaissance Plt | Engineer Co | Signal Co | Chemical Defense Plt | Materiel Support Co | Maintenance Co | Medical Plt | TOTAL |
|--|------------|------------------------|------------------|-------------------------|------------------------|-----------|--------------------|-------------|-----------|----------------------|---------------------|----------------|-------------|-------|
| <b>TRUCKS</b>  |            |                        |                  |                         |                        |           |                    |             |           |                      |                     |                |             |       |
| Truck, Utility   | 3          | 8                      | 1                |                         |                        |           |                    | 4           | 5         |                      | 2                   | 1              |             | 24    |
| Truck, Light   |            | 26                     | 1                | 4                       | 1                      |           |                    |             | 3         |                      | 4                   |                | 1           | 40    |
| Truck, Medium  | 1          | 8                      | 13               | 14                      | 4                      | 3         |                    | 9           |           |                      | 30                  | 2              | 2           | 86    |
| Truck, Crane   |            |                        | 1                |                         |                        |           |                    | 1           |           |                      |                     |                |             | 2     |
| Truck, Crane Shovel  |            |                        |                  |                         |                        |           |                    | 1           |           |                      |                     |                |             | 1     |
| Truck, Decon, ARS-12U/14   |            |                        |                  |                         |                        |           |                    |             |           | 3                    |                     |                |             | 3     |
| Truck, Decon, DDA-53/66  |            |                        |                  |                         |                        |           |                    |             |           | 1                    |                     |                | 1           | 2     |
| Truck, Dump  |            |                        |                  |                         |                        |           |                    | 2           |           |                      |                     |                |             | 2     |
| Truck, POL (5,000-L)   |            | 4                      | 4                | 2                       |                        |           |                    |             |           |                      | 10                  |                |             | 20    |
| Truck, Water (2,000-L)   |            |                        |                  |                         |                        |           |                    |             |           | 2                    | 3                   |                |             | 5     |
| Van, Command   | 3          |                        |                  |                         |                        |           |                    |             |           |                      |                     |                |             | 3     |
| Van, Hospital  |            |                        |                  |                         |                        |           |                    |             |           |                      |                     |                | 1           | 1     |
| Van, Kitchen   |            | 2                      | 1                |                         |                        |           |                    |             |           |                      |                     |                |             | 3     |
| Van, Maintenance   |            | 2                      | 1                | 2                       |                        |           |                    | 1           |           |                      | 1                   | 9              |             | 16    |
| Van, Signal  |            | 2                      | 2                | 4                       |                        |           |                    |             | 2         |                      |                     |                |             | 10    |
| Ambulance  |            | 2                      | 1                | 1                       |                        |           |                    |             |           |                      |                     |                | 4           | 8     |
| <b>TRAILERS</b>  |            |                        |                  |                         |                        |           |                    |             |           |                      |                     |                |             |       |
| Trailer, Cargo, 1-Axle   |            | 4                      | 1                |                         |                        |           |                    | 6           |           |                      |                     |                |             | 11    |
| Trailer, Cargo, 2-Axle   |            |                        | 7                | 16                      |                        |           |                    | 2           |           |                      | 20                  |                |             | 45    |
| Trailer, Generator   |            | 2                      | 3                | 2                       | 2                      |           |                    |             | 1         |                      | 1                   | 6              |             | 17    |
| Trailer, Kitchen   |            | 6                      |                  | 3                       |                        |           |                    | 1           |           |                      | 2                   | 3              | 1           | 16    |
| Trailer, POL (4,200-L)   |            | 6                      | 4                | 2                       |                        |           |                    |             |           |                      | 10                  |                |             | 22    |
| Trailer, Water (900-/1,200-L)                                      |            | 2                      | 1                | 1                       |                        |           |                    | 1           |           | 2                    | 1                   |                | 1           | 9     |
| <b>RADARS</b>  |            |                        |                  |                         |                        |           |                    |             |           |                      |                     |                |             |       |
| Radar, Battlefield Surveillance, Man-Portable, PSNR-1 or TALL MIKE |            |                        |                  |                         |                        | 1         |                    |             |           |                      |                     |                |             | 1     |
| <b>RADIOS</b>  |            |                        |                  |                         |                        |           |                    |             |           |                      |                     |                |             |       |
| VHF, Manpack, Low-Power  | 3          | 32                     | 5                | 10                      |                        | 4         | 3                  | 4           | 7         |                      | 1                   | 1              | 1           | 71    |
| VHF, Portable, Low-Power   |            | 44                     |                  |                         | 1                      |           |                    |             |           |                      |                     |                |             | 45    |
| VHF, Portable, Very-Low-Power                                      |            | 8                      |                  |                         |                        |           |                    |             |           |                      |                     |                |             | 8     |
| VHF, Vehicle Mount, Medium-Power                                   | 3          | 88                     | 37               | 27                      | 9                      | 16        | 3                  | 6           | 8         | 3                    |                     | 6              |             | 206   |
| HF, Manpack, Low-Power   |            |                        | 2                |                         |                        |           |                    |             | 2         | 1                    |                     |                |             | 5     |
| HF, Vehicle Mount, Medium-Power                                    | 1          | 4                      | 6                |                         |                        |           | 1                  | 1           | 2         |                      |                     |                |             | 15    |
| HF/VHF, Vehicle Mount, Med-Power                                   |            | 2                      |                  | 4                       |                        |           |                    |             | 2         |                      |                     |                |             | 8     |
| HF/VHF, Vehicle Mount, High-Power                                  |            |                        |                  |                         |                        |           |                    |             | 2         |                      |                     |                |             | 2     |
| HF, Vehicle Mount, High-Power                                      |            |                        |                  |                         |                        |           |                    |             | 1         |                      |                     |                |             | 1     |
| Radio Relay, VHF/UHF   |            |                        | 2                |                         |                        |           |                    |             | 2         |                      |                     |                |             | 4     |
| Warning Receiver   | 1          | 2                      | 1                | 2                       | 3                      |           |                    |             | 3         |                      |                     |                |             | 12    |
| <b>MISCELLANEOUS</b>   |            |                        |                  |                         |                        |           |                    |             |           |                      |                     |                |             |       |
| Rangefinder, Laser, SAGE GLOSS                                     |            |                        |                  | 4                       |                        |           |                    |             |           |                      |                     |                |             | 4     |
| Rangefinder, Steroscopic   |            | 2                      |                  |                         |                        | 1         |                    |             |           |                      |                     |                |             | 3     |
| Periscopic Aiming Circle   |            | 2                      |                  |                         |                        |           |                    |             |           |                      |                     |                |             | 2     |
| Collimator   |            | 12                     |                  |                         |                        |           |                    |             |           |                      |                     |                |             | 12    |
| Motorcycle   |            |                        |                  |                         |                        |           |                    |             | 3         |                      |                     |                |             | 3     |

**Mechanized Infantry Battalion (APC),  
Mech Inf Bde (Sep and Div)**

---

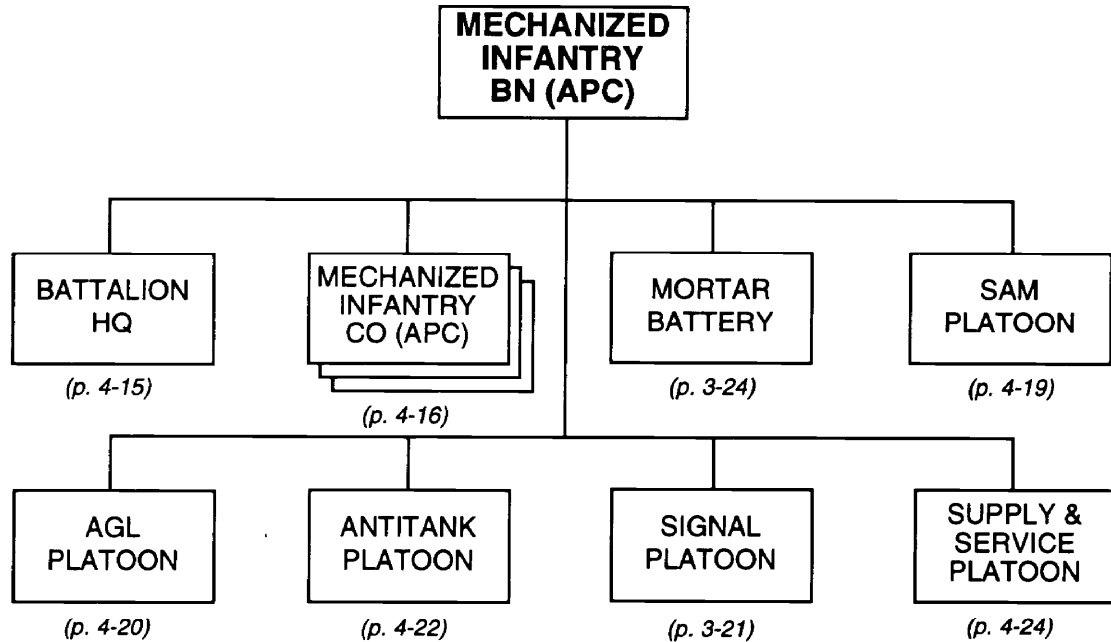

(continued on page 4-14)

**Mechanized Infantry Battalion (IFV), Mech Inf Bde  
(Sep and Div) and Tank Bde**

---

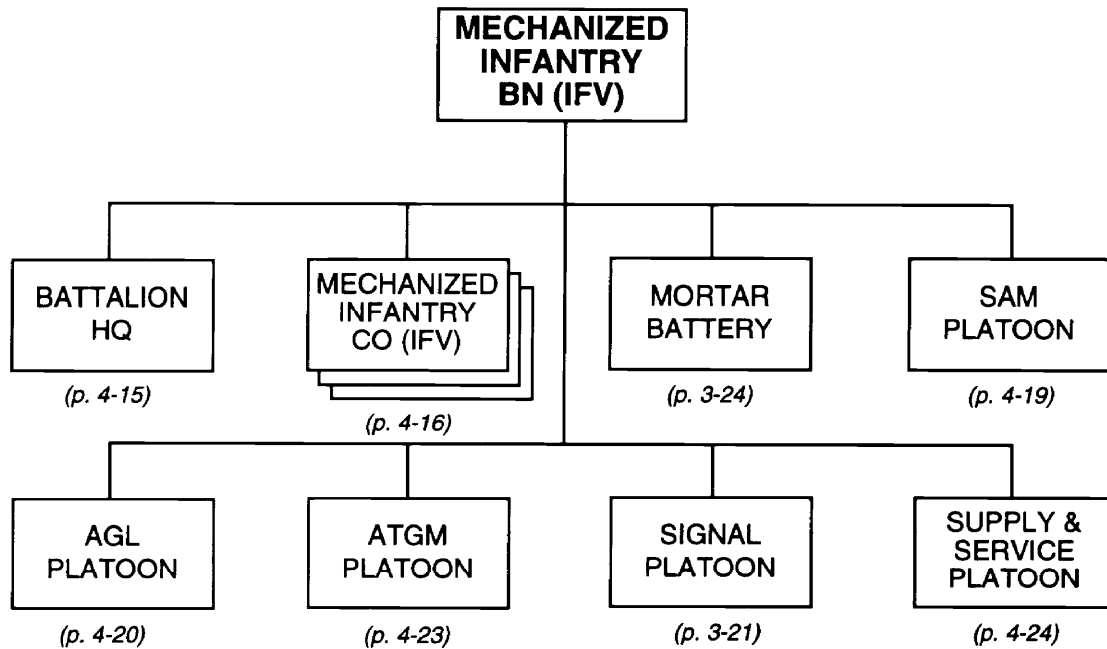

(continued on page 4-14)

**Mechanized Infantry Battalion (APC and IFV), Mech Inf Bde  
(Sep and Div) and Tank Bde (continued)**

---

**PRINCIPAL ITEMS OF EQUIPMENT**

| <u>Equipment</u>                  | <u>APC</u> | <u>IFV</u> | <u>Equipment</u>                      | <u>APC</u> | <u>IFV</u> |
|-----------------------------------|------------|------------|---------------------------------------|------------|------------|
| ACV, BTR-60PBK/70K/80K* .....     | 2          | 0          | Van, Signal.....                      | 1          | 1          |
| ACV, BMP-1K/2K** .....            | 0          | 2          | Ambulance .....                       | 1          | 1          |
| ACV, BTR (R-145BM)*** .....       | 1          | 1          | Trailer, Cargo, 1-Axle.....           | 2          | 2          |
| APC, BTR-60/70/80 .....           | 41         | 0          | Trailer, Generator.....               | 1          | 1          |
| IFV, BMP-1/2 .....                | 0          | 39         | Trailer, Kitchen.....                 | 3          | 3          |
| 9-mm Pistol, PM.....              | 158        | 155        | Trailer, POL (4,200-Liter) .....      | 1          | 3          |
| 5.45-mm Assault Rifle, AK-74..... | 324        | 318        | Trailer, POL (1,200-Liter) .....      | 1          | 0          |
| 5.45-mm LMG, RPK-74.....          | 23         | 23         | Trailer, Water (900-Liter).....       | 1          | 1          |
| 7.62-mm GP MG, PKM.....           | 6          | 6          | Rangefinder, Stereoscopic, DS-1 ..... | 1          | 1          |
| 7.62-mm Sniper Rifle, SVD .....   | 9          | 9          | Periscopic Aiming Circle, PAB2A ..    | 1          | 1          |
| 30-mm Automatic Grenade           |            |            | Collimator .....                      | 6          | 6          |
| Launcher, AGS-17 .....            | 6          | 6          | Night-Vision Goggles .....            | 46         | 46         |
| 40-mm Under-Barrel Grenade        |            |            | Night-Vision Goggles (Driver) .....   | 9          | 9          |
| Launcher, BG-15.....              | 60         | 60         | Night-Vision Sight (AGL) .....        | 6          | 6          |
| 120-mm Mortar, M1943/2S12 or      |            |            | Night-Vision Sight (Small Arms) ..    | 52         | 50         |
| 82-mm Mortar, M1937/2B9 .....     | 6          | 6          | Radios:                               |            |            |
| ATGM Manpack, AT-4/SPIGOT .....   | 6          | 6          | VHF, Manpack, Low-Power ....          | 16         | 16         |
| 73-mm Recoilless Gun, SPG-9.....  | 3          | 0          | VHF, Portable, Low-Power .....        | 25         | 22         |
| ATGL, RPG-7V.....                 | 33         | 33         | VHF, Portable, Very-                  |            |            |
| ATRL, RPG-18/22.....              | 36         | 34         | Low-Power.....                        | 4          | 4          |
| SAM, Shoulder-Fired.....          | 9          | 9          | VHF, Vehicle Mount,                   |            |            |
| Flamethrower, RPO .....           | 9          | 9          | Medium-Power .....                    | 46         | 44         |
| Truck, Utility .....              | 4          | 4          | HF, Vehicle Mount,                    |            |            |
| Truck, Light .....                | 13         | 13         | Medium-Power .....                    | 2          | 2          |
| Truck, Medium .....               | 4          | 4          | HF/VHF, Vehicle Mount                 |            |            |
| Truck, POL (5,000-Liter).....     | 3          | 2          | Medium-Power .....                    | 1          | 1          |
| Van, Kitchen.....                 | 1          | 1          | Warning Receiver .....                | 1          | 1          |
| Van, Maintenance .....            | 1          | 1          |                                       |            |            |

**FOOTNOTES:**

\* In some APC-equipped mechanized infantry battalions, an additional ACV, BTR (R-145BM) can replace one of these command vehicles.

\*\* In some IFV-equipped mechanized infantry battalions, an ACV, BMP-1KSh can replace one of these command vehicles.

\*\*\* Some IFV-equipped mechanized infantry battalions may have a tracked ACV, BMP-1KSh instead of the wheeled ACV, BTR (R-145BM) shown here.

Battalion Headquarters,  
Mech Inf Bn

---

|                                   |
|-----------------------------------|
| <b>BATTALION<br/>HEADQUARTERS</b> |
|-----------------------------------|

**PRINCIPAL ITEMS OF EQUIPMENT**

| <u>Equipment</u>                   | <u>Total</u> | <u>Equipment</u>               | <u>Total</u> |
|------------------------------------|--------------|--------------------------------|--------------|
| ACV, BMP-1K/2K or                  |              | Radios:                        |              |
| ACV, BTR-60PBK/70K/80K* .....      | 2            | VHF, Manpack, Low-Power .....  | 2            |
| 9-mm Pistol, PM .....              | 6            | VHF, Portable, Low-Power ..... | 1            |
| 5.45-mm Assault Rifle, AK-74 ..... | 8            | VHF, Vehicle Mount,            |              |
| Truck, Utility .....               | 1            | Medium-Power .....             | 2            |
| Truck, Light .....                 | 1            | HF, Vehicle Mount,             |              |
|                                    |              | Medium-Power .....             | 2            |
|                                    |              | Warning Receiver .....         | 1            |

**FOOTNOTE:** \* In IFV-equipped mechanized infantry battalions, an ACV, BMP-1KSh can replace one of these vehicles. In APC-equipped battalions, an ACV, BTR (R-145BM) can replace one of these command vehicles.

**Mechanized Infantry Company,  
Mech Inf Bn**

---

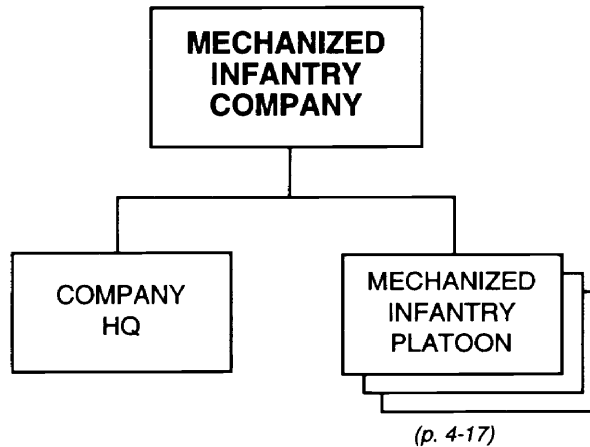

Company Commander.....PM  
 Deputy Commander.....PM  
 Logistics Officer .....PM  
 First Sergeant .....AK-74  
 Vehicle Driver .....PM  
 Vehicle Gunner .....PM

**PRINCIPAL ITEMS OF EQUIPMENT**

| <u>Equipment</u>                                   | <u>Total</u> |
|--|--------------|
| IFV, BMP-1/2 or APC, BTR-60/70/80.....             | 10           |
| 9-mm Pistol, PM.....                               | 35           |
| 5.45-mm Assault Rifle, AK-74.....                  | 58           |
| 5.45-mm LMG, RPK-74.....                           | 9            |
| 7.62-mm Sniper Rifle, SVD .....                    | 3            |
| 40-mm Under-Barrel Grenade Launcher,<br>BG-15..... | 18           |
| ATGL, RPG-7V .....                                 | 9            |
| ATRL, RPG-18/22.....                               | 10           |

| <u>Equipment</u>                          | <u>Total</u> |
|---|--------------|
| Flamethrower, RPO .....                   | 3            |
| Night-Vision Goggles .....                | 13           |
| Night-Vision Sight (Small Arms).....      | 9            |
| Radios:                                   |              |
| VHF, Manpack, Low-Power.....              | 1            |
| VHF, Portable, Low-Power .....            | 4            |
| VHF, Vehicle Mount,<br>Medium-Power ..... | 10           |



**Mechanized Infantry Platoon,  
Mech Inf Co**

---

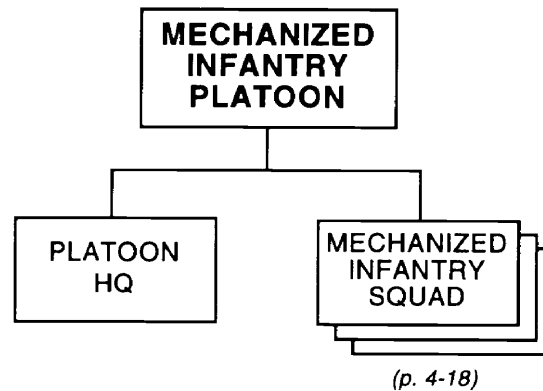

Platoon Leader..... PM  
Asst Plt Leader.....AK-74

**PRINCIPAL ITEMS OF EQUIPMENT**

| <u>Equipment</u>                                   | <u>Total</u> | <u>Equipment</u>                          | <u>Total</u> |
|--|--------------|---|--------------|
| IFV, BMP-1/2 or APC, BTR-60/70/80.....             | 3            | ATRL, RPG-18/22.....                      | 3            |
| 9-mm Pistol, PM.....                               | 10           | Flamethrower, RPO .....                   | 1            |
| 5.45-mm Assault Rifle, AK-74.....                  | 19           | Night-Vision Goggles .....                | 4            |
| 5.45-mm LMG, RPK-74.....                           | 3            | Night-Vision Sight (Small Arms).....      | 3            |
| 7.62-mm Sniper Rifle, SVD .....                    | 1            | Radios:                                   |              |
| 40-mm Under-Barrel Grenade Launcher,<br>BG-15..... | 6            | VHF, Portable, Low-Power .....            | 1            |
| ATGL, RPG-7V .....                                 | 3            | VHF, Vehicle Mount,<br>Medium-Power ..... | 3            |

**NOTE:** The platoon leader and assistant platoon leader each ride in one of the squad vehicles (IFV or APC).

**Mechanized Infantry Squad,  
Mech Inf Plt**

---

|   |
|---|
| <p><b>MECHANIZED<br/>INFANTRY<br/>SQUAD</b></p> |
|---|

Squad Leader/Vehicle Commander ..... AK-74  
 Asst Squad Leader/Vehicle Gunner ..... PM/AK-74  
 Vehicle Driver/Mechanic ..... PM  
 Machinegunner ..... RPK-74  
 Grenadier ..... RPG-7V/PM  
 Rifleman (x4) ..... AK-74

**PRINCIPAL ITEMS OF EQUIPMENT**

| <u>Equipment</u>                                   | <u>Total</u> | <u>Equipment</u>                                | <u>Total</u> |
|--|--------------|---|--------------|
| IFV, BMP-1/2 or APC, BTR-60/70/80.....             | 1            | ATGL, RPG-7V.....                               | 1            |
| 9-mm Pistol, PM.....                               | 3            | ATRL, RPG-18/22.....                            | 1            |
| 5.45-mm Assault Rifle, AK-74.....                  | 6*           | Night-Vision Goggles.....                       | 1            |
| 5.45-mm LMG, RPK-74.....                           | 1*           | Night-Vision Sight (Small Arms).....            | 1            |
| 40-mm Under-Barrel Grenade Launcher,<br>BG-15..... | 2            | Radio, VHF, Vehicle Mount,<br>Medium-Power..... | 1            |

**NOTES:**

1. One squad per platoon has an SVD sniper rifle.
2. Normally, one squad per platoon has a flamethrower, RPO. In some cases, however, there may be one flamethrower per squad.
3. The RPG-7V has a dedicated operator (grenadier), but the RPG- 18/22 does not.

**FOOTNOTE:** \* Some units have equipped the senior rifleman with an RPK-74 instead of an AK-74. This would change the equipment totals to five rifles and two machineguns.

**SAM Platoon, Mech Inf Bn  
or SAM Bn (SA-11)**

---

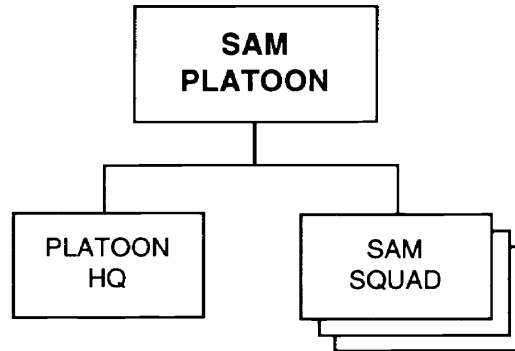

**PRINCIPAL ITEMS OF EQUIPMENT**

| <u>Equipment</u>                        | <u>Total</u> | <u>Equipment</u>                    | <u>Total</u> |
|---|--------------|-------------------------------------|--------------|
| SAM, Shoulder-Fired.....                | 9            | Radios:                             |              |
| IFV, BMP-1/2 or ACV, BTR-60/70/80 ..... | 3            | VHF, Portable, Very-Low-Power ..... | 4            |
| 9-mm Pistol, PM.....                    | 4            | VHF, Vehicle Mount,                 |              |
| 5.45-mm Assault Rifle, AK-74.....       | 9            | Medium-Power .....                  | 3            |
| Night-Vision Sight (Small Arms).....    | 3            |                                     |              |

*NOTE:* Depending on the situation, the battalion commander may retain the entire SAM platoon under his own control, or he may allocate its squads to individual mechanized infantry companies (or SA-11 batteries).

**Automatic Grenade Launcher Platoon,  
Mech Inf Bn**

---

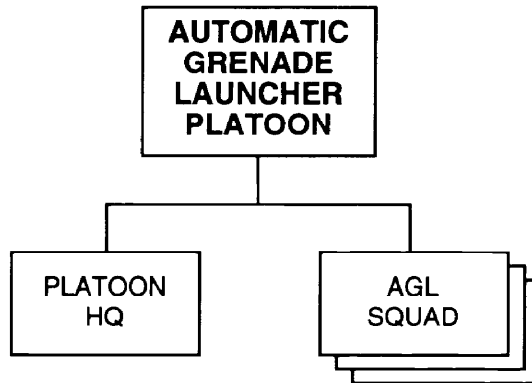

**PRINCIPAL ITEMS OF EQUIPMENT**

| <u>Equipment</u>                                  | <u>Total</u> | <u>Equipment</u>                          | <u>Total</u> |
|---|--------------|---|--------------|
| 30-mm Automatic Grenade Launcher,<br>AGS-17 ..... | 6            | Night-Vision Sight (AGL) .....            | 6            |
| IFV, BMP-1/2 or APC, BTR-60/70/80.....            | 3            | Night-Vision Sight (Small Arms) .....     | 3            |
| 9-mm Pistol, PM.....                              | 13           | Radios:                                   |              |
| 5.45-mm Assault Rifle, AK-74.....                 | 18           | VHF, Portable, Low-Power .....            | 4            |
| Night-Vision Goggles .....                        | 3            | VHF, Vehicle Mount,<br>Medium-Power ..... | 3            |

*NOTE:* Depending on the situation, the mechanized infantry battalion commander may retain the entire AGL platoon under his own control, or he may allocate its squads to individual mechanized infantry companies.

**Automatic Grenade Launcher Squad,  
AGL Plt, Mech Inf Bn**

---



Squad Leader .....AK-74  
 Senior Rifleman .....AK-74  
 Grenadier (x2)..... AGS-17, PM  
 Rifleman/Asst Grenadier (x4) .....AK-74  
 IFV/APC Driver/Mechanic ..... PM  
 IFV/APC Gunner..... PM

**PRINCIPAL ITEMS OF EQUIPMENT**

| <u>Equipment</u>                                  | <u>Total</u> |
|---|--------------|
| 30-mm Automatic Grenade Launcher,<br>AGS-17 ..... | 2            |
| 9-mm Pistol, PM.....                              | 4            |
| 5.45-mm Assault Rifle, AK-74.....                 | 6            |
| IFV, BMP-1/2 or APC, BTR-60/70/80.....            | 1            |
| Night-Vision Goggles.....                         | 1            |

| <u>Equipment</u>                          | <u>Total</u> |
|---|--------------|
| Night-Vision Sight (AGL) .....            | 2            |
| Night-Vision Sight (Small Arms).....      | 3            |
| Radios:                                   |              |
| VHF, Portable, Low-Power .....            | 1            |
| VHF, Vehicle Mount,<br>Medium-Power ..... | 1            |

**Antitank Platoon,  
Mech Inf Bn (APC)**

---

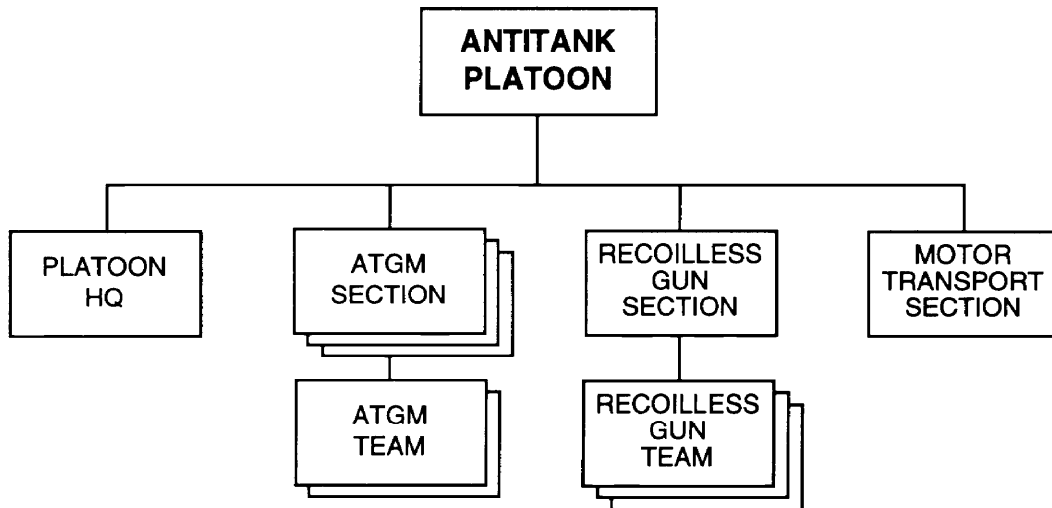

**PRINCIPAL ITEMS OF EQUIPMENT**

| <u>Equipment</u>                  | <u>Total</u> | <u>Equipment</u>                     | <u>Total</u> |
|-----------------------------------|--------------|--------------------------------------|--------------|
| APC, BTR-60/70/80 .....           | 5            | Night-Vision Sight (Small Arms)..... | 5            |
| ATGM Manpack, AT-4/SPIGOT .....   | 6            | Radios:                              |              |
| 73-mm Recoilless Gun, SPG-9 ..... | 3            | VHF, Portable, Low-Power .....       | 7            |
| 9-mm Pistol, PM.....              | 14           | VHF, Vehicle Mount,                  |              |
| 5.45-mm Assault Rifle, AK-74..... | 25           | Medium-Power .....                   | 5            |
| ATRL, RPG-18/22.....              | 5            |                                      |              |

**NOTES:**

1. ATGMs deploy by squads. Each squad consists of two teams, each containing one AT-4/SPIGOT launcher.
2. Recoilless guns deploy by teams. Each team contains one SPG-9.
3. Each APC can carry one or two recoilless gun teams or one ATGM section.
4. The platoon leader and assistant platoon leader ride in extra seats in the recoilless gun and ATGM vehicles.

**ATGM Platoon,  
Mech Inf Bn (IFV)**

---

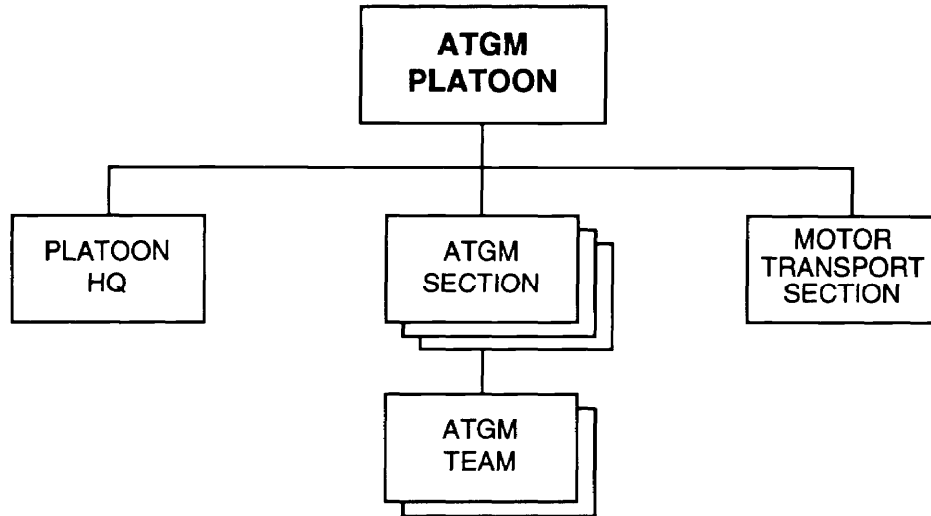

**PRINCIPAL ITEMS OF EQUIPMENT**

| <u>Equipment</u>                           | <u>Total</u> | <u>Equipment</u>                         | <u>Total</u> |
|--|--------------|--|--------------|
| ATGM Manpack Launcher,<br>AT-4/SPIGOT..... | 6            | Night-Vision Sight (Small Arms).....     | 3            |
| IFV, BMP-1/2.....                          | 3            | Radios:                                  |              |
| 9-mm Pistol, PM.....                       | 11           | VHF, Portable, Low-Power.....            | 4            |
| 5.45-mm Assault Rifle, AK-74.....          | 19           | VHF, Vehicle Mount,<br>Medium-Power..... | 3            |
| ATRL, RPG-18/22.....                       | 3            |  |              |

**NOTES:**

1. This platoon may have nine AT-7/SAXHORN launchers rather than the six AT-4/SPIGOT launchers shown here.
2. The IFV-equipped mechanized infantry battalion may divide this platoon's ATGM launchers and vehicles among the battalion's three mechanized infantry companies,
3. The platoon leader and assistant platoon leader ride in extra seats in the ATGM section vehicles.

**Supply and Service Platoon,  
Mech Inf Bn**

---

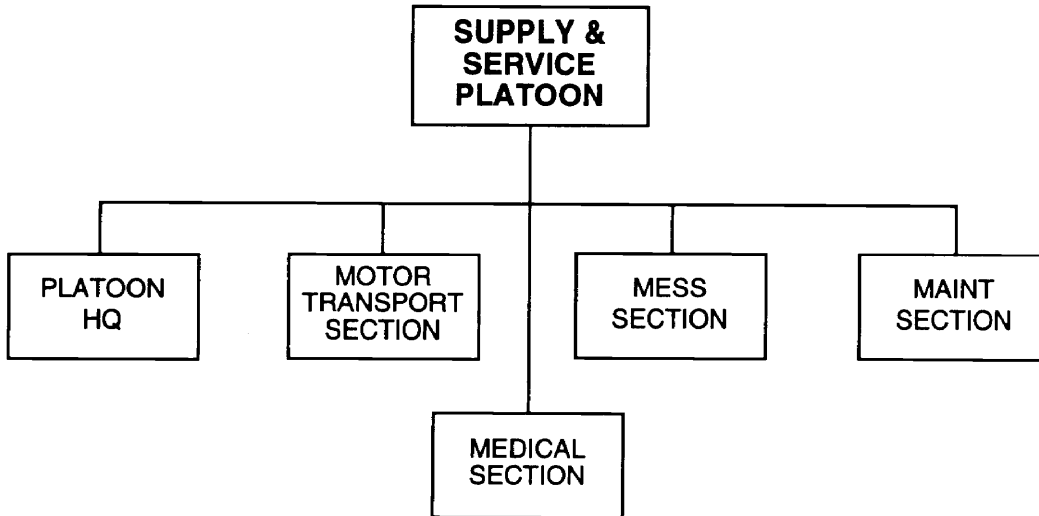

**PRINCIPAL ITEMS OF EQUIPMENT**

| <u>Equipment</u>                  | <u>APC</u> | <u>IFV</u> | <u>Equipment</u>                   | <u>APC</u> | <u>IFV</u> |
|-----------------------------------|------------|------------|------------------------------------|------------|------------|
| 9-mm Pistol, PM.....              | 1          | 1          | Trailer, Generator.....            | 1          | 1          |
| 5.45-mm Assault Rifle, AK-74..... | 30         | 30         | Trailer, Kitchen.....              | 3          | 3          |
| ATRL, RPG-18/22.....              | 1          | 1          | Trailer, POL (4,200-Liter) .....   | 1          | 3          |
| Truck, Utility .....              | 1          | 1          | Trailer, POL (1,200-Liter) .....   | 1          | 0          |
| Truck, Light .....                | 4          | 4          | Trailer, Water (900-Liter) .....   | 1          | 1          |
| Truck, Medium .....               | 4          | 4          | Night-Vision Goggles (Driver)..... | 3          | 3          |
| Truck, POL (5,000-Liter).....     | 3          | 2          | Night-Vision Sight (Small Arms)..  | 6          | 6          |
| Van, Kitchen .....                | 1          | 1          | Radios:                            |            |            |
| Van, Maintenance .....            | 1          | 1          | VHF, Manpack, Low-Power ....       | 3          | 3          |
| Ambulance .....                   | 1          | 1          | VHF, Portable, Low-Power .....     | 1          | 1          |
| Trailer, Cargo, 1-Axle.....       | 2          | 2          |                                    |            |            |

*NOTE:* Equipment totals vary for APC-equipped and IFV-equipped mechanized infantry battalions. The primary difference is in the required POL transport capability.



**Self-Propelled Antiaircraft Gun Battery (23-mm), Mech Inf Bde (Sep and Div) and Tank Bde, or SP Arty Regt**

---

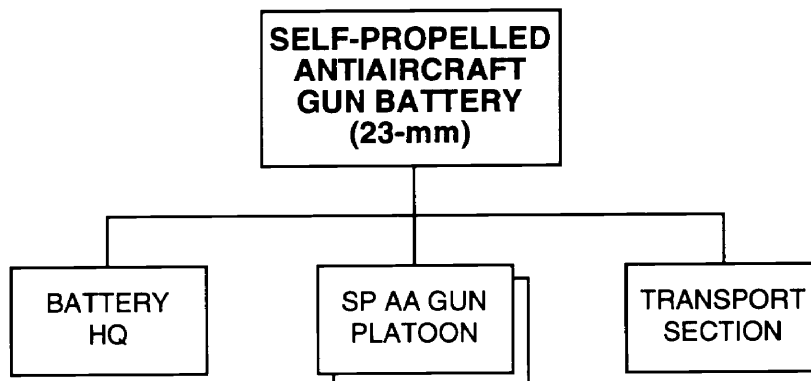

**PRINCIPAL ITEMS OF EQUIPMENT**

| <u>Equipment</u>                | <u>Total</u> | <u>Equipment</u>               | <u>Total</u> |
|---------------------------------|--------------|--------------------------------|--------------|
| 23-mm SP AA Gun, ZSU-23-4*..... | 8            | Radios:                        |              |
| ACV, BTR-60 (PU-12).....        | 1            | VHF, Portable, Low-Power ..... | 1            |
| Truck, Light .....              | 1            | VHF, Vehicle Mount,            |              |
| Truck, Medium .....             | 4            | Medium-Power .....             | 9            |
| Trailer, Generator.....         | 2            | Warning Receiver .....         | 3            |

*NOTE:* Some mechanized infantry brigades have an air defense battery with one SA-9/GASKIN platoon (4 SAM launchers) and one ZSU-23-4 platoon (4 guns).

*FOOTNOTE:* \* This system includes the GUN DISH fire control radar.

**Antitank Battalion, Mech Inf Bde (Sep) or Mech Inf Div  
or Army or CDF or National**

---

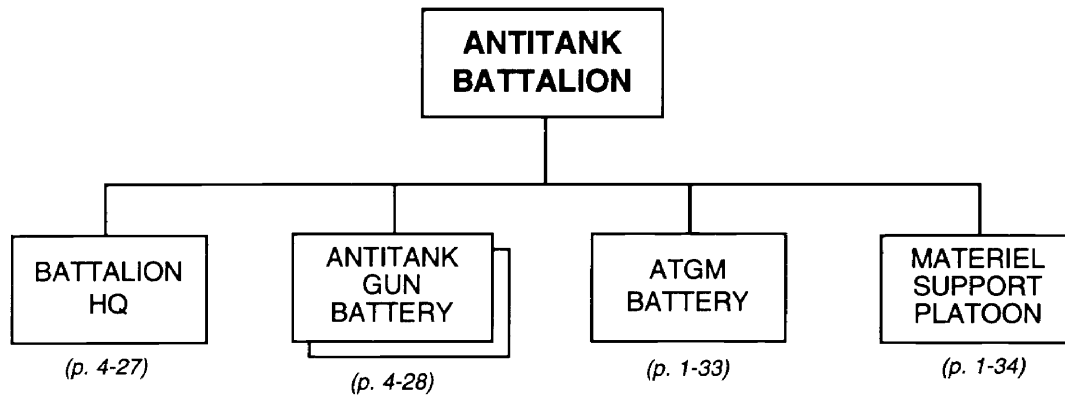

**PRINCIPAL ITEMS OF EQUIPMENT**

| <u>Equipment</u>  | <u>Total</u> |
|---|--------------|
| ATGM Vehicle, 9P133 w/AT-3/SAGGER<br>or 9P148 w/AT-5/SPANDREL ..... | 9            |
| 100-mm Antitank Gun, T-12/MT-12 .....                               | 12           |
| ATGL, RPG-7V .....  | 9            |
| ACV, BTR (R-145BM)/BRDM-2U .....                                    | 1            |
| ACV, BRDM-2U .....  | 4            |
| Mobile Recon Post, PRP-3/4* .....                                   | 1            |
| Prime Mover, MT-LBT .....   | 14           |
| Truck, Utility .....  | 3            |
| Truck, Light .....  | 4            |
| Truck, Medium .....   | 12           |
| Truck, POL (5,000-Liter) .....                                      | 3            |
| Van, Maintenance .....  | 2            |
| Van, Signal .....   | 2            |
| Ambulance .....   | 1            |
| Trailer, Cargo, 2-Axle .....  | 10           |
| Trailer, Generator .....  | 1            |

| <u>Equipment</u>   | <u>Total</u> |
|--|--------------|
| Trailer, Kitchen .....   | 1            |
| Trailer, POL (4,200-Liter) .....   | 3            |
| Trailer, Water (900-Liter) .....   | 1            |
| Rangefinder, Stereoscopic, DS-1 .....  | 3            |
| Radar, Battlefield Surveillance, Man-<br>Portable, PSNR-1 or TALL MIKE ..... | 3            |
| Radios:  |              |
| VHF, Manpack, Low-Power .....  | 10           |
| VHF, Vehicle Mount,<br>Medium-Power .....                                    | 28           |
| HF, Vehicle Mount,<br>Medium-Power .....                                     | 1            |
| HF/VHF, Vehicle Mount,<br>Medium-Power .....                                 | 3            |
| Radio Relay, VHF/UHF .....   | 1            |
| Warning Receiver .....   | 1            |

**FOOTNOTE:** \* This system includes the SMALL FRED or TALL MIKE battlefield surveillance radar.

**Battalion Headquarters, Antitank Bn, Mech Inf Bde (Sep)  
or Mech Inf Div or CDF or National** \_\_\_\_\_

|  |
|--|
| <p><b>BATTALION<br/>HEADQUARTERS</b></p> |
|--|

**PRINCIPAL ITEMS OF EQUIPMENT**

| <u>Equipment</u>                          | <u>Total</u> | <u>Equipment</u>                             | <u>Total</u> |
|---|--------------|--|--------------|
| ACV, BTR (R-145BM) .....                  | 1            | HF, Vehicle Mount,<br>Medium-Power .....     | 1            |
| Mobile Recon Post, PRP-3/4* .....         | 1            | HF/VHF, Vehicle Mount,<br>Medium-Power ..... | 2            |
| Truck, Utility .....                      | 2            | Warning Receiver .....                       | 1            |
| Radios:                                   |              |  |              |
| VHF, Manpack, Low-Power .....             | 1            |  |              |
| VHF, Vehicle Mount,<br>Medium-Power ..... | 1            |  |              |

**FOOTNOTE:** \* This system includes the SMALL FRED or TALL MIKE battlefield surveillance radar.

**Antitank Gun Battery, Antitank Bn, Mech Inf Bde (Sep)  
or Mech Inf Div or CDF or National**

---

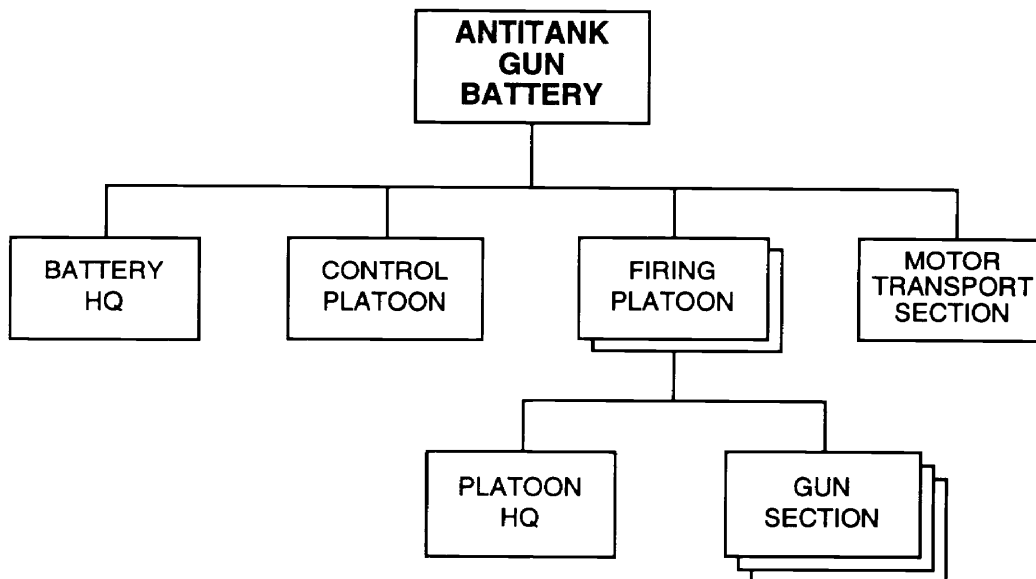

**PRINCIPAL ITEMS OF EQUIPMENT**

| <u>Equipment</u>                     | <u>Total</u> |
|--------------------------------------|--------------|
| 100-mm Antitank Gun, T-12/MT-12..... | 6            |
| Prime Mover, MT-LBT .....            | 7            |
| Truck, Medium .....                  | 1            |
| Trailer, Cargo, 2-Axle.....          | 1            |
| Rangefinder, Stereoscopic, DS-1..... | 1            |

| <u>Equipment</u>   | <u>Total</u> |
|--|--------------|
| Radar, Battlefield Surveillance, Man-<br>Portable, PSNR-1 or TALL MIKE ..... | 1            |
| Radios:  |              |
| VHF, Manpack, Low-Power .....  | 1            |
| VHF, Vehicle Mount,<br>Medium-Power .....                                    | 7            |

**Reconnaissance Company, Mech Inf Bde (APC) (Sep),  
Mtzd Inf Bde (Sep), and Inf Bde (Sep)** \_\_\_\_\_

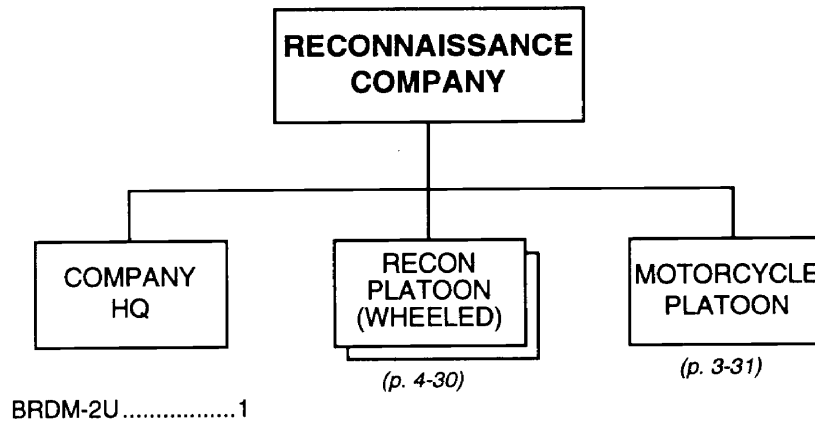

**PRINCIPAL ITEMS OF EQUIPMENT**

| <u>Equipment</u>                                   | <u>Total</u> |
|--|--------------|
| ACV, BRDM-2U.....                                  | 1            |
| ASC, BRDM-2 .....                                  | 8            |
| 9-mm Pistol, PM.....                               | 11           |
| 5.45-mm Assault Rifle, AK-74.....                  | 47           |
| 40-mm Under-Barrel Grenade Launcher,<br>BG-15..... | 13           |
| ATRL, RPG-18/22.....                               | 9            |
| Motorcycle .....                                   | 9            |
| Night-Vision Goggles .....                         | 13           |
| Night-Vision Sight (Small Arms) .....              | 9            |

| <u>Equipment</u>   | <u>Total</u> |
|--|--------------|
| Radar, Battlefield Surveillance, Man-<br>Portable, PSNR-1 or TALL MIKE ..... | 2            |
| Radios:  |              |
| VHF, Portable, Low-Power .....   | 13           |
| VHF, Vehicle Mount,<br>Medium-Power .....                                    | 9            |
| HF, Vehicle Mount,<br>Medium-Power .....                                     | 1            |
| Warning Receiver .....   | 1            |

Reconnaissance Platoon (Wheeled), Mtzd Inf Bde (Div) and Inf Bde (Div),  
 or Recon Co, Mtzd Inf Bde (Sep), Inf Bde (Sep), Mech Inf Bde (APC or IFV) (Sep),  
 and Tank Bde \_\_\_\_\_

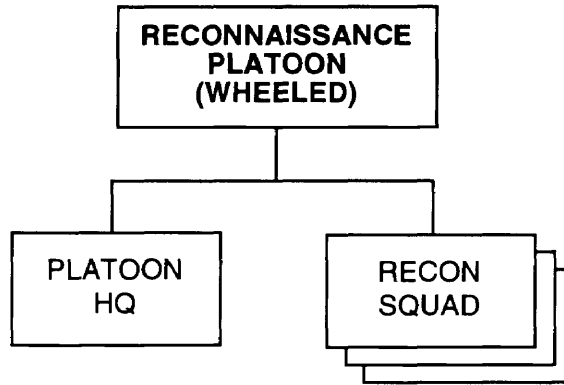

**PRINCIPAL ITEMS OF EQUIPMENT**

| <u>Equipment</u>                                   | <u>Total</u> |
|--|--------------|
| ASC, BRDM-2* .....                                 | 4            |
| 9-mm Pistol, PM.....                               | 1            |
| 5.45-mm Assault Rifle, AK-74.....                  | 15           |
| 40-mm Under-Barrel Grenade Launcher,<br>BG-15..... | 4            |
| ATRL, RPG-18/22.....                               | 4            |
| Night-Vision Goggles .....                         | 4            |

| <u>Equipment</u>   | <u>Total</u> |
|--|--------------|
| Night-Vision Sight (Small Arms).....   | 4            |
| Radar, Battlefield Surveillance, Man-<br>Portable, PSNR-1 or TALL MIKE ..... | 1            |
| Radios:  |              |
| VHF, Portable, Low-Power .....   | 4            |
| VHF, Vehicle Mount,<br>Medium-Power .....                                    | 4            |

**FOOTNOTE:** \* When this platoon is not part of a parent reconnaissance company, a BRDM-2U armored command vehicle can replace the BRDM-2 in the platoon headquarters. The BRDM-2U carries one additional radio (HF, vehicle mount, medium-power).

**Reconnaissance Company, Mech Inf Bde  
(IFV) (Sep) and Tank Bde**

---

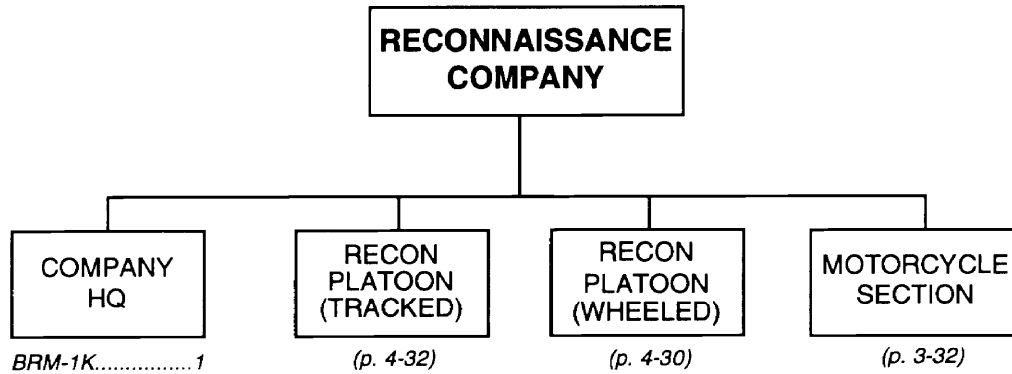

**PRINCIPAL ITEMS OF EQUIPMENT**

| <u>Equipment</u>                                    | <u>Total</u> | <u>Equipment</u>   | <u>Total</u> |
|---|--------------|--|--------------|
| ASC, BRDM-2 .....                                   | 4            | Night-Vision Sight (Small Arms) .....  | 8            |
| ACV, BRM-1K* .....                                  | 2            | Radar, Battlefield Surveillance, Man-<br>Portable, PSNR-1 or TALL MIKE ..... | 1            |
| IFV, BMP-1/2 .....                                  | 2            | Radios:  |              |
| 9-mm Pistol, PM .....                               | 15           | VHF, Manpack, Low-Power .....  | 4            |
| 5.45-mm Assault Rifle, AK-74 .....                  | 36           | VHF, Portable, Low-Power .....   | 5            |
| 5.45-mm LMG, RPK-74 .....                           | 3            | VHF, Vehicle Mount,<br>Medium-Power .....                                    | 8            |
| ATGL, RPG-7V .....                                  | 3            | HF, Vehicle Mount,<br>Medium-Power .....                                     | 1            |
| ATRL, RPG-18/22 .....                               | 8            | Warning Receiver .....   | 1            |
| 40-mm Under-Barrel Grenade Launcher,<br>BG-15 ..... | 7            |  |              |
| Motorcycle .....                                    | 3            |  |              |
| Night-Vision Goggles .....                          | 9            |  |              |

**NOTES:**

1. The mix of BMP and BRM vehicles within a tracked reconnaissance platoon can vary.
2. The motorcycle section may also provide courier service.

Reconnaissance Platoon (Tracked), Mech Inf Bde (IFV) (Div), or Recon Co,  
 Mech Inf Bde (IFV) (Sep) and Tank Bde, or Recon Co, Recon & EC Bn,  
 Mech Inf Div or MD or Army or CDF or DMI \_\_\_\_\_

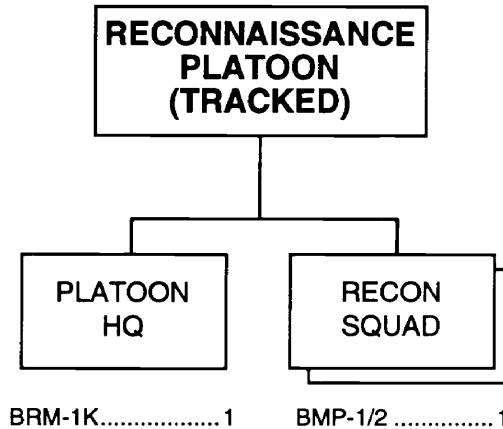

**PRINCIPAL ITEMS OF EQUIPMENT**

| <u>Equipment</u>                  | <u>Total</u> | <u>Equipment</u>                     | <u>Total</u> |
|-----------------------------------|--------------|--------------------------------------|--------------|
| ACV, BRM-1K* .....                | 1            | 40-mm Under-Barrel Grenade Launcher, |              |
| IFV, BMP-1/2 .....                | 2            | BG-15.....                           | 3            |
| 9-mm Pistol, PM.....              | 10           | Night-Vision Goggles .....           | 3            |
| 5.45-mm Assault Rifle, AK-74..... | 11           | Night-Vision Sight (Small Arms)..... | 3            |
| 5.45-mm LMG, RPK-74.....          | 3            | Radios:                              |              |
| ATGL, RPG-7V.....                 | 3            | VHF, Manpack, Low-Power.....         | 3            |
| ATRL, RPG-18/22.....              | 3            | VHF, Vehicle Mount,                  |              |
|                                   |              | Medium-Power .....                   | 3            |

*NOTE:* The mix of BRM-1K and BMP vehicles can vary.

*FOOTNOTE:* \* This vehicle includes the TALL MIKE battlefield surveillance radar. When this platoon is not part of a parent reconnaissance company, the BRM-1K carries one additional radio (HF, vehicle mount, medium-power).



Engineer Company, Mech Inf Bde (Sep and Div)  
or Mech Inf Div or MD

---

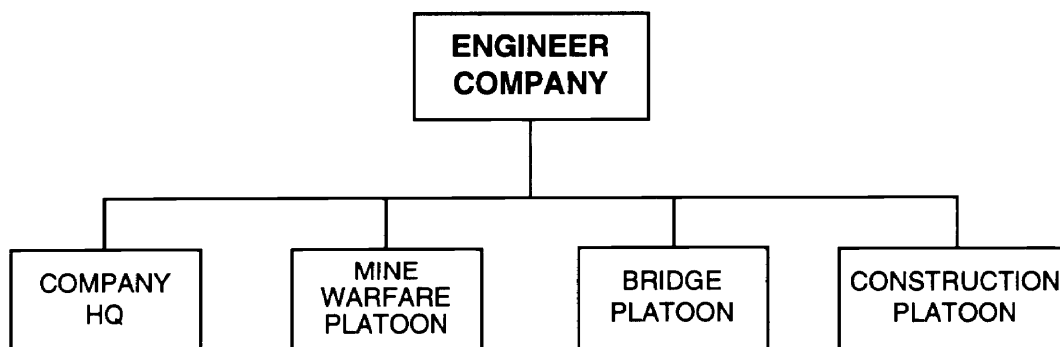

**PRINCIPAL ITEMS OF EQUIPMENT**

| <u>Equipment</u>                 | <u>Total</u> | <u>Equipment</u>                    | <u>Total</u> |
|----------------------------------|--------------|-------------------------------------|--------------|
| ACV, BTR (R-145BM) .....         | 1            | Bridge, Tank-Launched .....         | 1            |
| ATRL, RPG-18/22.....             | 4            | Bridge, Truck-Launched .....        | 4            |
| Flamethrower, LPO/RPO.....       | 4            | Ditching Machine, PZM/TMK .....     | 4            |
| Truck, Utility .....             | 4            | Armored Engineer Tractor, IMR ..... | 1            |
| Truck, Medium .....              | 9            | Route-Clearing Vehicle, BAT .....   | 1            |
| Truck, Crane .....               | 1            | Minelayer, GMZ .....                | 3            |
| Truck, Crane Shovel .....        | 1            | Mine Detector, DIM.....             | 1            |
| Truck, Dump.....                 | 2            | Radios:                             |              |
| Truck, Water Purification .....  | 1            | VHF, Vehicle Mount,                 |              |
| Van, Maintenance .....           | 1            | Medium-Power .....                  | 6            |
| Trailer, Cargo, 1-Axle.....      | 6            | HF or VHF, Manpack,                 |              |
| Trailer, Cargo, 2-Axle.....      | 2            | Low-Power.....                      | 4            |
| Trailer, Kitchen.....            | 1            | HF, Vehicle Mount,                  |              |
| Trailer, Water (900-Liter) ..... | 1            | Medium-Power .....                  | 1            |

*NOTE:* A mechanized infantry division or military district may have only an engineer company organic to it. However, it would probably receive additional support from national-level engineer organizations.

Signal Company, Mech Inf Bde (Sep and Div)  
and Tank Bde, or Mech Inf Div or MD

---

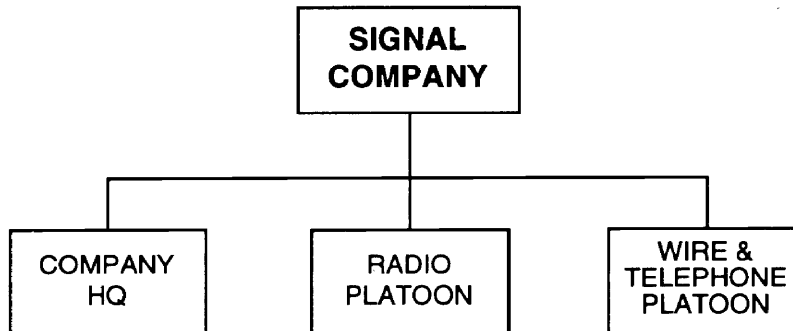

**PRINCIPAL ITEMS OF EQUIPMENT**

| <u>Equipment</u>             | <u>Total</u> | <u>Equipment</u>                   | <u>Total</u> |
|------------------------------|--------------|------------------------------------|--------------|
| ACV, BMP-1KSh.....           | 5*/0**       | HF, Manpack, Low-Power.....        | 2            |
| ACV, BTR (R-145BM) .....     | 3*/8**       | HF, Vehicle Mount,                 |              |
| Truck, Utility .....         | 5            | Medium-Power .....                 | 2            |
| Truck, Light .....           | 3            | HF, Vehicle Mount, High-Power..... | 1            |
| Van, Signal.....             | 2            | HF/VHF, Vehicle Mount,             |              |
| Motorcycle .....             | 3            | Medium-Power .....                 | 2            |
| Trailer, Generator.....      | 1            | HF/VHF, Vehicle Mount,             |              |
| Radios:                      |              | High-Power .....                   | 2            |
| VHF, Manpack, Low-Power..... | 7            | Radio Relay, VHF/UHF.....          | 2            |
| VHF, Vehicle Mount,          |              | Warning Receiver .....             | 3            |
| Medium-Power .....           | 8            |                                    |              |

*NOTES:*

1. The radios listed normally support the brigade headquarters, but the brigade may attach some to subordinate headquarters.
2. A mechanized infantry division with only a signal company organic to it will probably receive additional signal support from the national asset pool.
3. Motorcycles provide the brigade commander with messenger/courier service.
4. Field telephones and switchboards are standard equipment in the wire and telephone platoon.

*FOOTNOTES:*

- \* Equipment levels for the signal company, mechanized infantry brigade (IFV) and tank brigade.
- \*\* Equipment levels for the signal company, mechanized infantry brigade (APC).

Maintenance Company, Mech Inf Bde (Sep and Div)  
and Tank Bde, or MD \_\_\_\_\_

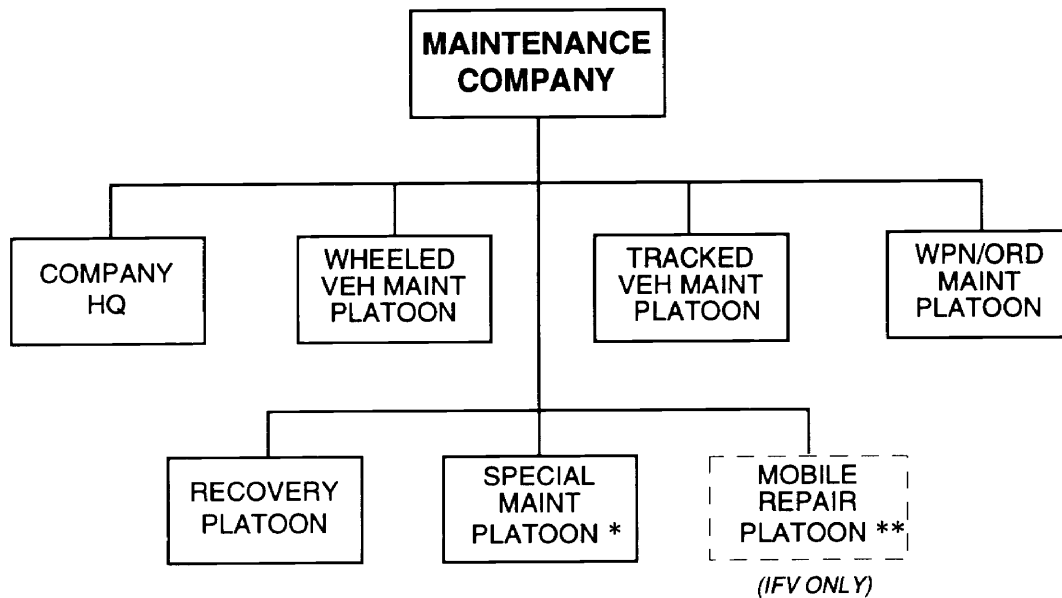

**PRINCIPAL ITEMS OF EQUIPMENT**

| <u>Equipment</u>                          | <u>Total</u> | <u>Equipment</u>                          | <u>Total</u> |
|---|--------------|---|--------------|
| Van, Maintenance .....                    | 9            | Trailer, Cargo, 2-Axle.....               | 6            |
| Armored Maintenance Vehicle,<br>MTP ..... | 0-3**        | Trailer, Generator.....                   | 3            |
| ATGL, RPG-7V .....                        | 3            | Radios:                                   |              |
| Armored Recovery Vehicle .....            | 3            | VHF, Manpack, Low-Power.....              | 1            |
| Truck, Utility .....                      | 1            | VHF, Vehicle Mount,<br>Medium-Power ..... | 3-6**        |
| Truck, Medium .....                       | 2            |   |              |

**FOOTNOTES:**

\* The special maintenance platoon consists of an arc and gas welding section, battery repair and recharging section, and electrical repair section.

\*\* The mobile repair platoon is only present in IFV-equipped mechanized infantry brigades. Such a brigade would have three additional MTP vehicles, each with a radio.

Tank Brigade (94-Tank Standard)

---

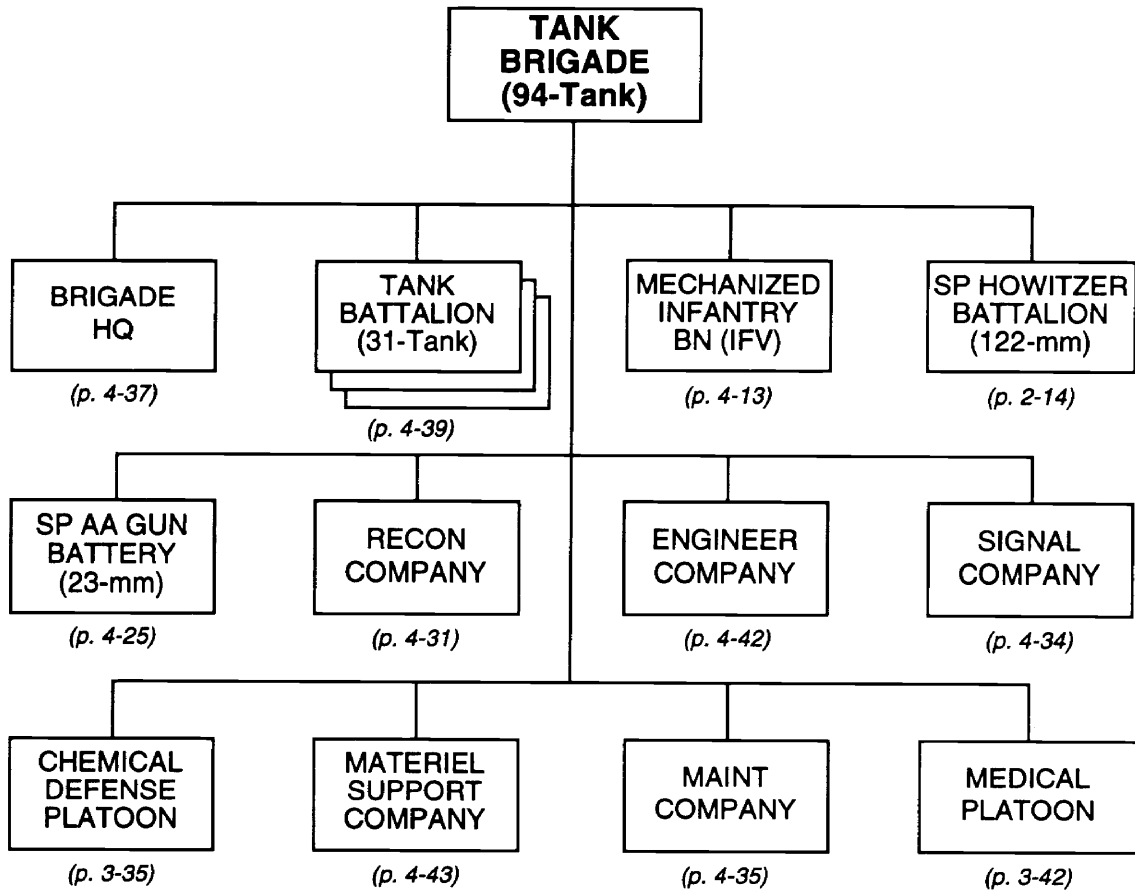

NOTE: In a CDF tank brigade, the mechanized infantry battalion is most likely IFV-equipped.

(continued)

## Tank Brigade (94-Tank Standard) (continued)

| Principal Items of Equipment                           | Brigade HQ | Tank Bn (3x) | Mech Inf Bn (IFV) | SP Howitzer Bn (122-mm) | SP AA Gun Btry (23-mm) | Reconnaissance Co | Engineer Co | Signal Co | Chemical Defense Plt | Materiel Support Co | Maintenance Co | Medical Plt | TOTAL |
|--|------------|--------------|-------------------|-------------------------|------------------------|-------------------|-------------|-----------|----------------------|---------------------|----------------|-------------|-------|
| <b>ARMORED VEHICLES</b>                                |            |              |                   |                         |                        |                   |             |           |                      |                     |                |             |       |
| Medium Tank, T-55K/62K                                 | 1          | 3            |                   |                         |                        |                   |             |           |                      |                     |                |             | 4     |
| Medium Tank, T-55/62                                   |            | 90           |                   |                         |                        |                   |             |           |                      |                     |                |             | 90    |
| APC, BTR-60/70/80                                      | 1          |              |                   |                         |                        |                   |             |           |                      |                     |                |             | 1     |
| APC, BTR-60PA (FAC)                                    | 1          |              |                   |                         |                        |                   |             |           |                      |                     |                |             | 1     |
| APC, BTR-60 (PU-12)                                    |            |              |                   |                         | 1                      |                   |             |           |                      |                     |                |             | 1     |
| ACV, BTR (R-145BM)                                     |            | 3            | 1                 |                         |                        |                   | 1           | 8         |                      |                     |                |             | 13    |
| ACV, BMP-1K/2K   |            | 3            | 2                 |                         |                        |                   |             |           |                      |                     |                |             | 5     |
| IFV, BMP-1/2   |            |              | 39                |                         |                        | 2                 |             |           |                      |                     |                |             | 41    |
| ACV, BRM-1K*   |            |              |                   |                         |                        | 2                 |             |           |                      |                     |                |             | 2     |
| Mobile Recon Post, PRP-3/4**                           |            |              |                   | 1                       |                        |                   |             |           |                      |                     |                |             | 1     |
| ASC, BRDM-2  |            |              |                   |                         |                        | 4                 |             |           |                      |                     |                |             | 4     |
| Chem Recon Vehicle, BRDM-2RKh/RKhM                     |            |              |                   |                         |                        |                   |             |           | 3                    |                     |                |             | 3     |
| ACRV, 1V13/1V13M/1V22 (Btry FDC)                       |            |              |                   | 3                       |                        |                   |             |           |                      |                     |                |             | 3     |
| ACRV, 1V14/1V14M/1V23 (Btry COP)                       |            |              |                   | 3                       |                        |                   |             |           |                      |                     |                |             | 3     |
| ACRV, 1V15/1V15M/1V24 (Bn COP)                         |            |              |                   | 1                       |                        |                   |             |           |                      |                     |                |             | 1     |
| ACRV, 1V16/1V16M/1V25 (Bn FDC)                         |            |              |                   | 1                       |                        |                   |             |           |                      |                     |                |             | 1     |
| Armored Recovery Vehicle                               |            |              |                   |                         |                        |                   |             |           |                      |                     | 5              |             | 5     |
| <b>WEAPONS</b>   |            |              |                   |                         |                        |                   |             |           |                      |                     |                |             |       |
| 30-mm Auto Grenade Lchr, AGS-17                        |            |              | 6                 |                         |                        |                   |             |           |                      |                     |                |             | 6     |
| 120-mm Mortar, M1943/2S12 or<br>82-mm Mortar M1937/2B9 |            |              | 6                 |                         |                        |                   |             |           |                      |                     |                |             | 6     |
| 122-mm SP Howitzer, 2S1                                |            |              |                   | 18                      |                        |                   |             |           |                      |                     |                |             | 18    |
| ATGM Manpack, AT-4/SPIGOT                              |            |              | 6                 |                         |                        |                   |             |           |                      |                     |                |             | 6     |
| 23-mm SP AA Gun, ZSU-23-4***                           |            |              |                   |                         | 8                      |                   |             |           |                      |                     |                |             | 8     |
| SAM, Shoulder-Fired                                    | 3          |              | 9                 | 18                      |                        |                   |             |           |                      |                     |                |             | 30    |
| Flamethrower, RPO                                      |            |              | 9                 |                         |                        |                   | 4           |           |                      |                     |                |             | 13    |
| <b>ENGINEER EQUIPMENT</b>                              |            |              |                   |                         |                        |                   |             |           |                      |                     |                |             |       |
| Bridge, Tank-Launched                                  |            |              |                   |                         |                        |                   | 3           |           |                      |                     |                |             | 3     |
| Bridge, Truck-Launched                                 |            |              |                   |                         |                        |                   | 4           |           |                      |                     |                |             | 4     |
| Ditching Machine, BTM/MDK                              |            |              |                   |                         |                        |                   | 1           |           |                      |                     |                |             | 1     |
| Ditching Machine, PZM/TMK                              |            |              |                   |                         |                        |                   | 3           |           |                      |                     |                |             | 3     |
| Route-Clearing Vehicle, BAT                            |            |              |                   |                         |                        |                   | 1           |           |                      |                     |                |             | 1     |
| Dozer Blade, BTU                                       |            |              |                   |                         |                        |                   | 3           |           |                      |                     |                |             | 3     |
| Armored Engineer Tractor, IMR                          |            |              |                   |                         |                        |                   | 1           |           |                      |                     |                |             | 1     |
| Minelayer, GMZ   |            |              |                   |                         |                        |                   | 3           |           |                      |                     |                |             | 3     |
| Mineclearing Plow                                      |            |              |                   |                         |                        |                   | 27          |           |                      |                     |                |             | 27    |
| Mine Roller-Plow                                       |            |              |                   |                         |                        |                   | 9           |           |                      |                     |                |             | 9     |
| Mine Detector, DIM                                     |            |              |                   |                         |                        |                   | 1           |           |                      |                     |                |             | 1     |
| Truck, Water Purification                              |            |              |                   |                         |                        |                   | 1           |           |                      |                     |                |             | 1     |

**FOOTNOTES:**

\* This vehicle includes the TALL MIKE battlefield surveillance radar.

\*\* This vehicle includes the SMALL FRED or TALL MIKE battlefield surveillance radar.

\*\*\* This vehicle includes the GUN DISH fire control radar.

(continued)

**Tank Brigade (94-Tank Standard)**  
**(continued)**

| <i>Principal Items of Equipment</i>                                | <i>Brigade HQ</i> | <i>Tank Bn (3x)</i> | <i>Mech Inf Bn (IFV)</i> | <i>SP Howitzer Bn (122-mm)</i> | <i>SP AA Gun Btry (23-mm)</i> | <i>Reconnaissance Co</i> | <i>Engineer Co</i> | <i>Signal Co</i> | <i>Chemical Defense Plt</i> | <i>Material Support Co</i> | <i>Maintenance Co</i> | <i>Medical Plt</i> | <i>TOTAL</i> |
|--|-------------------|---------------------|--------------------------|--------------------------------|-------------------------------|--------------------------|--------------------|------------------|-----------------------------|----------------------------|-----------------------|--------------------|--------------|
| <b>TRUCKS</b>  |                   |                     |                          |                                |                               |                          |                    |                  |                             |                            |                       |                    |              |
| Truck, Utility   | 3                 |                     | 4                        |                                |                               |                          | 4                  | 5                |                             | 2                          | 1                     |                    | 19           |
| Truck, Light   |                   |                     | 13                       | 4                              | 1                             |                          |                    | 3                |                             | 4                          |                       | 1                  | 26           |
| Truck, Medium  | 1                 | 21                  | 4                        | 14                             | 4                             |                          | 36                 |                  |                             | 45                         | 2                     | 2                  | 129          |
| Truck, Crane   |                   |                     |                          |                                |                               |                          | 1                  |                  |                             |                            |                       |                    | 1            |
| Truck, Crane Shovel  |                   |                     |                          |                                |                               |                          | 1                  |                  |                             |                            |                       |                    | 1            |
| Truck, Decon, ARS-12U/14   |                   |                     |                          |                                |                               |                          |                    |                  | 3                           |                            |                       |                    | 3            |
| Truck, Decon, DDA-53/66  |                   |                     |                          |                                |                               |                          |                    |                  | 1                           |                            |                       | 1                  | 2            |
| Truck, Dump  |                   |                     |                          |                                |                               |                          | 2                  |                  |                             |                            |                       |                    | 2            |
| Truck, POL (5,000-L)   |                   | 12                  | 2                        | 2                              |                               |                          |                    |                  |                             | 15                         |                       |                    | 31           |
| Truck, Water (2,000-L)   |                   |                     |                          |                                |                               |                          |                    |                  | 2                           | 4                          |                       |                    | 6            |
| Van, Command   | 3                 |                     |                          |                                |                               |                          |                    |                  |                             |                            |                       |                    | 3            |
| Van, Hospital  |                   |                     |                          |                                |                               |                          |                    |                  |                             |                            |                       | 1                  | 1            |
| Van, Kitchen   |                   | 3                   | 1                        |                                |                               |                          |                    |                  |                             |                            |                       |                    | 4            |
| Van, Maintenance   |                   | 3                   | 1                        | 2                              |                               |                          | 1                  |                  |                             | 1                          | 12                    |                    | 20           |
| Van, Signal  |                   |                     | 1                        | 4                              |                               |                          |                    | 2                |                             |                            |                       |                    | 7            |
| Ambulance  |                   | 3                   | 1                        | 1                              |                               |                          |                    |                  |                             |                            |                       | 4                  | 9            |
| <b>TRAILERS</b>  |                   |                     |                          |                                |                               |                          |                    |                  |                             |                            |                       |                    |              |
| Trailer, Cargo, 1-Axle   |                   | 3                   | 2                        |                                |                               |                          | 6                  |                  |                             |                            |                       |                    | 11           |
| Trailer, Cargo, 2-Axle   |                   | 18                  |                          | 16                             |                               |                          | 2                  |                  |                             | 30                         | 6                     |                    | 72           |
| Trailer, Generator   |                   | 3                   | 1                        | 2                              | 2                             |                          |                    | 1                |                             | 1                          | 3                     |                    | 13           |
| Trailer, Kitchen   |                   |                     | 3                        | 3                              |                               |                          | 1                  |                  |                             | 2                          |                       | 1                  | 10           |
| Trailer, POL (4,200-L)   |                   | 12                  | 3                        | 2                              |                               |                          |                    |                  |                             | 15                         |                       |                    | 32           |
| Trailer, Water (900-/1,200-L)                                      |                   | 3                   | 1                        | 1                              |                               |                          | 1                  |                  | 2                           | 1                          |                       | 1                  | 10           |
| <b>RADARS</b>  |                   |                     |                          |                                |                               |                          |                    |                  |                             |                            |                       |                    |              |
| Radar, Battlefield Surveillance, Man-Portable, PSNR-1 or TALL MIKE |                   |                     |                          |                                |                               | 1                        |                    |                  |                             |                            |                       |                    | 1            |
| <b>RADIOS</b>  |                   |                     |                          |                                |                               |                          |                    |                  |                             |                            |                       |                    |              |
| VHF, Manpack, Low-Power  | 2                 | 3                   | 16                       | 10                             |                               | 4                        | 4                  | 7                |                             | 1                          | 1                     | 1                  | 49           |
| VHF, Portable, Low-Power   |                   |                     | 22                       |                                | 1                             | 5                        |                    |                  |                             |                            |                       |                    | 28           |
| VHF, Portable, Very-Low-Power                                      |                   |                     | 4                        |                                |                               |                          |                    |                  |                             |                            |                       |                    | 4            |
| VHF, Vehicle Mount, Medium-Power                                   | 3                 | 99                  | 44                       | 27                             | 9                             | 8                        | 8                  | 8                | 3                           |                            | 5                     |                    | 214          |
| HF, Manpack, Low-Power   |                   | 6                   |                          |                                |                               |                          |                    | 2                | 1                           |                            |                       |                    | 9            |
| HF, Vehicle Mount, Medium-Power                                    | 1                 | 15                  | 2                        |                                |                               | 1                        | 1                  | 2                |                             |                            |                       |                    | 22           |
| HF/VHF, Vehicle Mount, Med-Power                                   |                   |                     | 1                        | 4                              |                               |                          |                    | 2                |                             |                            |                       |                    | 7            |
| HF/VHF, Vehicle Mount, High-Power                                  |                   |                     |                          |                                |                               |                          |                    | 2                |                             |                            |                       |                    | 2            |
| HF, Vehicle Mount, High-Power                                      |                   |                     |                          |                                |                               |                          |                    | 1                |                             |                            |                       |                    | 1            |
| Radio Relay, VHF/UHF   |                   |                     |                          |                                |                               |                          |                    | 2                |                             |                            |                       |                    | 2            |
| Warning Receiver   | 1                 | 3                   | 1                        | 2                              | 3                             | 1                        |                    | 3                |                             |                            |                       |                    | 14           |
| <b>MISCELLANEOUS</b>   |                   |                     |                          |                                |                               |                          |                    |                  |                             |                            |                       |                    |              |
| Rangefinder, Laser, SAGE GLOSS                                     |                   |                     |                          | 4                              |                               |                          |                    |                  |                             |                            |                       |                    | 4            |
| Rangefinder, Steroscopic   |                   |                     | 1                        |                                |                               |                          |                    |                  |                             |                            |                       |                    | 1            |
| Periscopic Aiming Circle   |                   |                     | 1                        |                                |                               |                          |                    |                  |                             |                            |                       |                    | 1            |
| Collimator   |                   |                     | 6                        |                                |                               |                          |                    |                  |                             |                            |                       |                    | 6            |
| Motorcycle   |                   |                     |                          |                                |                               | 3                        |                    | 3                |                             |                            |                       |                    | 6            |

**Tank Battalion (31-Tank Standard),  
Tank Bde (94-Tank Standard)**

---

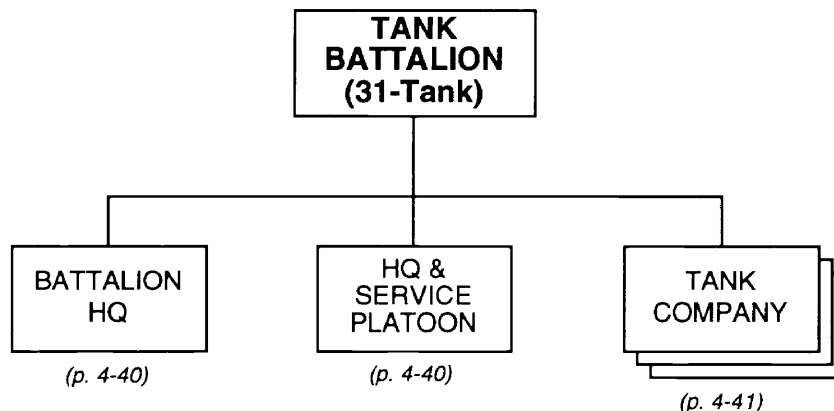

**PRINCIPAL ITEMS OF EQUIPMENT**

| <u>Equipment</u>                                 | <u>Total</u> | <u>Equipment</u>                          | <u>Total</u> |
|--|--------------|---|--------------|
| Medium Tank, T-55K/62K<br>(Command Vehicle)..... | 1            | Trailer, Cargo, 2-Axle.....               | 6            |
| Medium Tank, T-55/62.....                        | 30           | Trailer, Generator.....                   | 1            |
| ATGL, RPG-7V.....                                | 2            | Trailer, POL (4,200-Liter) .....          | 4            |
| ACV, BMP-1K/2K.....                              | 1            | Trailer, Water (900-Liter).....           | 1            |
| ACV, BTR (R-145BM) .....                         | 1            | Radios:                                   |              |
| Truck, Medium.....                               | 7            | VHF, Manpack, Low-Power.....              | 1            |
| Truck, POL (5,000-Liter).....                    | 4            | VHF, Vehicle Mount,<br>Medium-Power ..... | 33           |
| Van, Kitchen.....                                | 1            | HF, Manpack, Low-Power.....               | 2            |
| Van, Maintenance.....                            | 1            | HF, Vehicle Mount,<br>Medium-Power .....  | 5            |
| Ambulance.....                                   | 1            | Warning Receiver .....                    | 1            |
| Trailer, Cargo, 1-Axle.....                      | 1            |   |              |

*NOTE:* Most tank brigades have the standard 31-tank battalion structure. However, the 22-tank variant is also possible (p. 4-47).

**Battalion Headquarters, Tank Bn, Tank Bde  
or Separate Tank Bn**

---

|                                   |
|-----------------------------------|
| <b>BATTALION<br/>HEADQUARTERS</b> |
|-----------------------------------|

**PRINCIPAL ITEMS OF EQUIPMENT**

| <u>Equipment</u>                                 | <u>Total</u> | <u>Equipment</u>                          | <u>Total</u> |
|--|--------------|---|--------------|
| Medium Tank, T-55K/62K<br>(Command Vehicle)..... | 1            | Radios:                                   |              |
| ACV, BTR (R-145BM) .....                         | 1            | HF, Vehicle Mount,<br>Medium-Power .....  | 3            |
| ACV, BMP-1K/2K .....                             | 1            | HF, Manpack, Low-Power.....               | 1            |
| ATGL, RPG-7V .....                               | 2            | VHF, Vehicle Mount,<br>Medium-Power ..... | 3            |
| 9-mm Pistol, PM.....                             | 4            | Warning Receiver .....                    | 1            |
| 5.45-mm Assault Rifle, AKS-74 .....              | 8            |   |              |
| Night-Vision Sight (Small Arms).....             | 2            |   |              |

**Headquarters and Service Platoon,  
Tank Bn, Tank Bde**

---

|   |
|---|
| <b>HEADQUARTERS<br/>&amp; SERVICE<br/>PLATOON</b> |
|---|

**PRINCIPAL ITEMS OF EQUIPMENT**

| <u>Equipment</u>                  | <u>Total</u> | <u>Equipment</u>                     | <u>Total</u> |
|-----------------------------------|--------------|--------------------------------------|--------------|
| 9-mm Pistol, PM.....              | 1            | Trailer, Generator.....              | 1            |
| 5.45-mm Assault Rifle, AK-74..... | 22           | Trailer, POL (4,200-Liter) .....     | 3*/4**       |
| Truck, Medium .....               | 7            | Trailer, Water (900-Liter) .....     | 1            |
| Truck, POL (5,000-Liter).....     | 3*/4**       | Night-Vision Goggles .....           | 2            |
| Van, Kitchen .....                | 1            | Night-Vision Sight (Small Arms)..... | 4            |
| Van, Maintenance .....            | 1            | Radios:                              |              |
| Ambulance .....                   | 1            | VHF, Manpack, Low-Power.....         | 1            |
| Trailer, Cargo, 1-Axle.....       | 1            | HF, Manpack, Low-Power.....          | 1            |
| Trailer, Cargo, 2-Axle.....       | 6            |                                      |              |

**FOOTNOTES:**

- \* Equipment levels for 22-tank battalion.
- \*\* Equipment levels for 31-tank battalion.



**Tank Company (10-Tank Standard), Tank Bn (31-Tank Standard)  
or Separate Tank Bn**

---

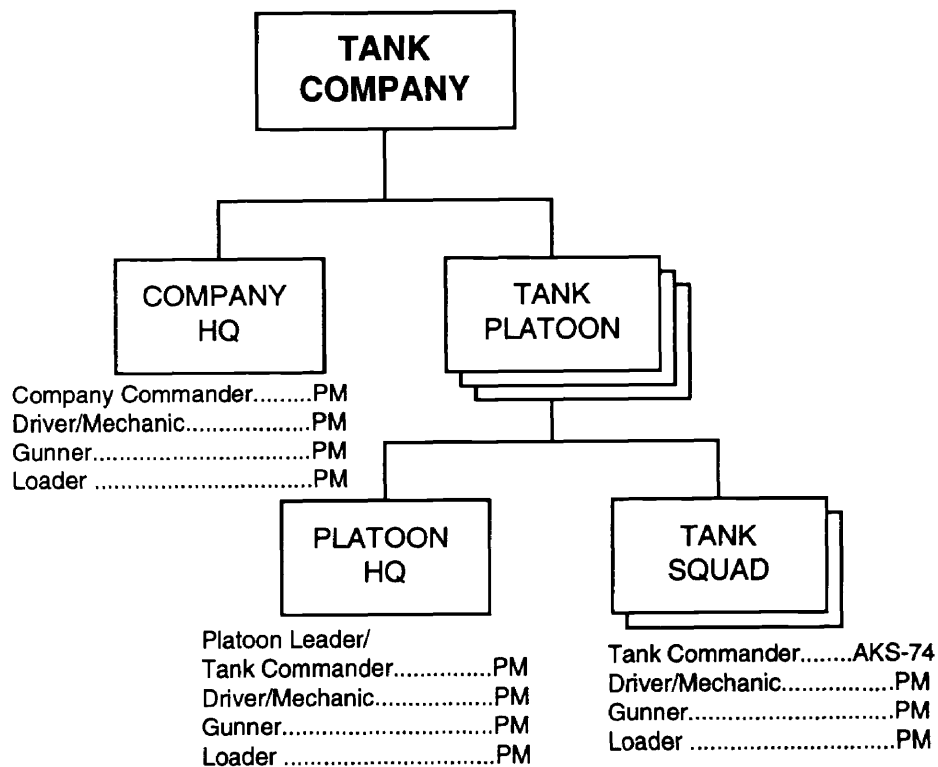

**PRINCIPAL ITEMS OF EQUIPMENT**

| <u>Equipment</u>                    | <u>Total</u> |
|-------------------------------------|--------------|
| Medium Tank, T-55/62.....           | 10           |
| 9-mm Pistol, PM.....                | 34           |
| 5.45-mm Assault Rifle, AKS-74 ..... | 6            |

| <u>Equipment</u>                          | <u>Total</u> |
|---|--------------|
| Radios:                                   |              |
| VHF, Vehicle Mount,<br>Medium-Power ..... | 10           |
| HF, Vehicle Mount,<br>Medium-Power .....  | 1            |

Engineer Company, Tank Bde

---

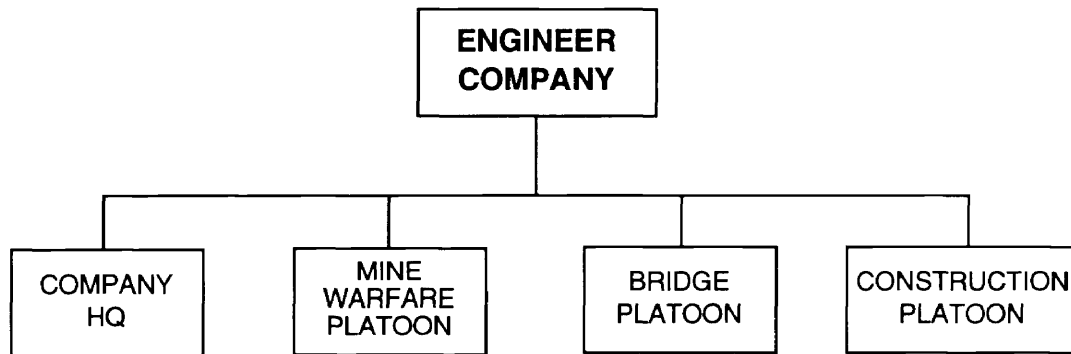

**PRINCIPAL ITEMS OF EQUIPMENT**

| <u>Equipment</u>                 | <u>Total</u> |
|----------------------------------|--------------|
| ACV, BTR(R-145BM) .....          | 1            |
| ATRL, RPG-18/22 .....            | 4            |
| Flamethrower, LPO/RPO .....      | 4            |
| Truck, Utility .....             | 4            |
| Truck, Medium .....              | 33*/36**     |
| Truck, Crane .....               | 1            |
| Truck, Crane Shovel .....        | 1            |
| Truck, Dump .....                | 2            |
| Truck, Water Purification .....  | 1            |
| Van, Maintenance .....           | 1            |
| Trailer, Cargo, 1-Axle .....     | 6            |
| Trailer, Cargo, 2-Axle .....     | 2            |
| Trailer, Kitchen .....           | 1            |
| Trailer, Water (900-Liter) ..... | 1            |
| Bridge, Tank-Launched .....      | 3            |
| Bridge, Truck-Launched .....     | 4            |

| <u>Equipment</u>                          | <u>Total</u> |
|---|--------------|
| Ditching Machine, PZM/TMK .....           | 3            |
| Ditching Machine, BTM/MDK .....           | 1            |
| Route-Clearing Vehicle, BAT .....         | 1            |
| Dozer Blade, BTU .....                    | 3            |
| Armored Engineer Tractor, IMR .....       | 1            |
| Minelayer, GMZ .....                      | 3            |
| Mineclearing Plow .....                   | 18*/27**     |
| Mine Roller-Plow .....                    | 9            |
| Mine Detector, DIM .....                  | 1            |
| Radios:                                   |              |
| VHF, Vehicle Mount,<br>Medium-Power ..... | 8            |
| HF or VHF, Manpack,<br>Low-Power .....    | 4            |
| HF, Vehicle Mount,<br>Medium-Power .....  | 1            |

**FOOTNOTES:**

- \* Equipment levels for 67-tank brigade.
- \*\* Equipment levels for 94-tank brigade.

Materiel Support Company, Tank Bde \_\_\_\_\_

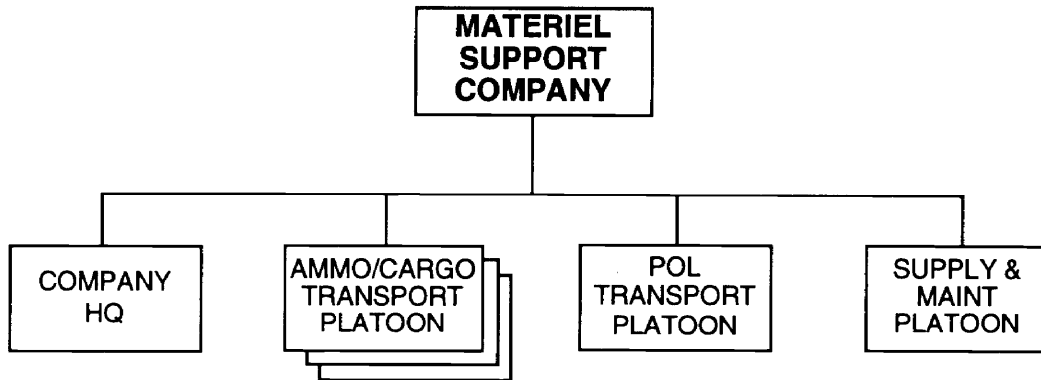

**PRINCIPAL ITEMS OF EQUIPMENT**

| <u>Equipment</u>                 | <u>67-Tank</u> | <u>94-Tank</u> | <u>Equipment</u>                 | <u>67-Tank</u> | <u>94-Tank</u> |
|----------------------------------|----------------|----------------|----------------------------------|----------------|----------------|
| Truck, Utility .....             | 2              | 2              | Trailer, Generator.....          | 1              | 1              |
| Truck, Light .....               | 4              | 4              | Trailer, Kitchen.....            | 2              | 2              |
| Truck, Medium .....              | 30             | 45             | Trailer, POL (4,200-Liter) ..... | 10             | 15             |
| Truck, POL (5,000-Liter).....    | 10             | 15             | Trailer, Water (900-Liter) ..... | 1              | 1              |
| Truck, Water (2,000-Liter) ..... | 3              | 4              | Radio, VHF, Manpack,             |                |                |
| Van, Maintenance .....           | 1              | 1              | Low-Power.....                   | 1              | 1              |
| Trailer, Cargo, 2-Axle.....      | 15             | 0              |                                  |                |                |

Tank Brigade (67-Tank Variant)

---

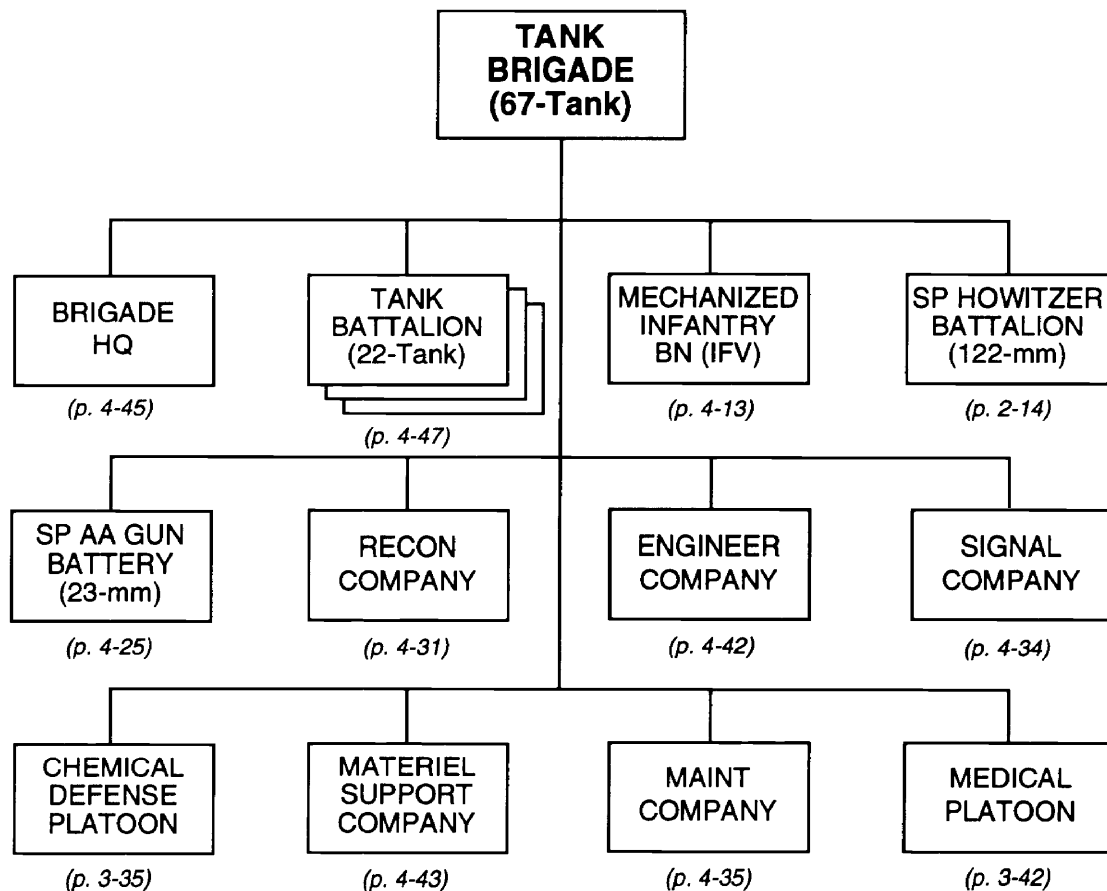

**NOTES:**

1. Tank battalions in this brigade have the 22-tank structure.
2. The mechanized infantry battalion is normally IFV-equipped. However, an APC-equipped battalion is possible in some cases. The principal items of equipment that follows includes equipment totals for an IFV-equipped battalion.

**(continued)**

**Tank Brigade (67-Tank Variant)**  
**(continued)**

| <b>Principal Items of Equipment</b>                    | <b>Brigade HQ</b> | <b>Tank Bn (3x)</b> | <b>Mech Inf Bn (IFV)</b> | <b>SP Howitzer Bn (122-mm)</b> | <b>SP AA Gun Btry (23-mm)</b> | <b>Reconnaissance Co</b> | <b>Engineer Co</b> | <b>Signal Co</b> | <b>Chemical Defense Plt</b> | <b>Material Support Co</b> | <b>Maintenance Co</b> | <b>Medical Plt</b> | <b>TOTAL</b> |
|--|-------------------|---------------------|--------------------------|--------------------------------|-------------------------------|--------------------------|--------------------|------------------|-----------------------------|----------------------------|-----------------------|--------------------|--------------|
| <b>ARMORED VEHICLES</b>                                |                   |                     |                          |                                |                               |                          |                    |                  |                             |                            |                       |                    |              |
| Medium Tank, T-55K/62K                                 | 1                 | 3                   |                          |                                |                               |                          |                    |                  |                             |                            |                       |                    | 4            |
| Medium Tank, T-55/62                                   |                   | 63                  |                          |                                |                               |                          |                    |                  |                             |                            |                       |                    | 63           |
| APC, BTR-60/70/80                                      | 1                 |                     |                          |                                |                               |                          |                    |                  |                             |                            |                       |                    | 1            |
| APC, BTR-60PA (FAC)                                    | 1                 |                     |                          |                                |                               |                          |                    |                  |                             |                            |                       |                    | 1            |
| APC, BTR-60 (PU-12)                                    |                   |                     |                          |                                | 1                             |                          |                    |                  |                             |                            |                       |                    | 1            |
| ACV, BTR (R-145BM)                                     |                   | 3                   | 1                        |                                |                               |                          | 1                  | 8                |                             |                            |                       |                    | 13           |
| ACV, BMP-1K/2K   |                   | 3                   | 2                        |                                |                               |                          |                    |                  |                             |                            |                       |                    | 5            |
| IFV, BMP-1/2   |                   |                     | 39                       |                                |                               | 2                        |                    |                  |                             |                            |                       |                    | 41           |
| ACV, BRM-1K*   |                   |                     |                          |                                |                               | 2                        |                    |                  |                             |                            |                       |                    | 2            |
| Mobile Recon Post, PRP-3/4**                           |                   |                     |                          | 1                              |                               |                          |                    |                  |                             |                            |                       |                    | 1            |
| ASC, BRDM-2  |                   |                     |                          |                                |                               | 4                        |                    |                  |                             |                            |                       |                    | 4            |
| Chem Recon Vehicle, BRDM-2RKh/RKhM                     |                   |                     |                          |                                |                               |                          |                    |                  | 3                           |                            |                       |                    | 3            |
| ACRV, 1V13/1V13M/1V22 (Btry FDC)                       |                   |                     |                          | 3                              |                               |                          |                    |                  |                             |                            |                       |                    | 3            |
| ACRV, 1V14/1V14M/1V23 (Btry COP)                       |                   |                     |                          | 3                              |                               |                          |                    |                  |                             |                            |                       |                    | 3            |
| ACRV, 1V15/1V15M/1V24 (Bn COP)                         |                   |                     |                          | 1                              |                               |                          |                    |                  |                             |                            |                       |                    | 1            |
| ACRV, 1V16/1V16M/1V25 (Bn FDC)                         |                   |                     |                          | 1                              |                               |                          |                    |                  |                             |                            |                       |                    | 1            |
| Armored Recovery Vehicle                               |                   |                     |                          |                                |                               |                          |                    |                  |                             |                            | 3                     |                    | 3            |
| <b>WEAPONS</b>   |                   |                     |                          |                                |                               |                          |                    |                  |                             |                            |                       |                    |              |
| 30-mm Auto Grenade Lchr, AGS-17                        |                   |                     | 6                        |                                |                               |                          |                    |                  |                             |                            |                       |                    | 6            |
| 120-mm Mortar, M1943/2S12 or<br>82-mm Mortar M1937/2B9 |                   |                     | 6                        |                                |                               |                          |                    |                  |                             |                            |                       |                    | 6            |
| 122-mm SP Howitzer, 2S1                                |                   |                     |                          | 18                             |                               |                          |                    |                  |                             |                            |                       |                    | 18           |
| ATGM Manpack, AT-4/SPIGOT                              |                   |                     | 6                        |                                |                               |                          |                    |                  |                             |                            |                       |                    | 6            |
| 23-mm SP AA Gun, ZSU-23-4***                           |                   |                     |                          |                                | 8                             |                          |                    |                  |                             |                            |                       |                    | 8            |
| SAM, Shoulder-Fired                                    | 3                 |                     | 9                        | 18                             |                               |                          |                    |                  |                             |                            |                       |                    | 30           |
| Flamethrower, LPO/RPO                                  |                   |                     | 9                        |                                |                               | 4                        |                    |                  |                             |                            |                       |                    | 13           |
| <b>ENGINEER EQUIPMENT</b>                              |                   |                     |                          |                                |                               |                          |                    |                  |                             |                            |                       |                    |              |
| Bridge, Tank-Launched                                  |                   |                     |                          |                                |                               | 3                        |                    |                  |                             |                            |                       |                    | 3            |
| Bridge, Truck-Launched                                 |                   |                     |                          |                                |                               | 4                        |                    |                  |                             |                            |                       |                    | 4            |
| Ditching Machine, BTM/MDK                              |                   |                     |                          |                                |                               | 1                        |                    |                  |                             |                            |                       |                    | 1            |
| Ditching Machine, PZM/TMK                              |                   |                     |                          |                                |                               | 3                        |                    |                  |                             |                            |                       |                    | 3            |
| Route-Clearing Vehicle, BAT                            |                   |                     |                          |                                |                               | 1                        |                    |                  |                             |                            |                       |                    | 1            |
| Dozer Blade, BTU                                       |                   |                     |                          |                                |                               | 3                        |                    |                  |                             |                            |                       |                    | 3            |
| Armored Engineer Tractor, IMR                          |                   |                     |                          |                                |                               | 1                        |                    |                  |                             |                            |                       |                    | 1            |
| Minelayer, GMZ   |                   |                     |                          |                                |                               | 3                        |                    |                  |                             |                            |                       |                    | 3            |
| Mineclearing Plow                                      |                   |                     |                          |                                |                               | 18                       |                    |                  |                             |                            |                       |                    | 18           |
| Mine Roller-Plow                                       |                   |                     |                          |                                |                               | 9                        |                    |                  |                             |                            |                       |                    | 9            |
| Mine Detector, DIM                                     |                   |                     |                          |                                |                               | 1                        |                    |                  |                             |                            |                       |                    | 1            |
| Truck, Water Purification                              |                   |                     |                          |                                |                               | 1                        |                    |                  |                             |                            |                       |                    | 1            |

**FOOTNOTES:**

\* This vehicle includes the TALL MIKE battlefield surveillance radar.

\*\* This vehicle includes the SMALL FRED or TALL MIKE battlefield surveillance radar.

\*\*\* This vehicle includes the GUN DISH fire control radar.

(continued)

Tank Brigade (67-Tank Variant)  
(continued)

| Principal Items of Equipment                                       | Brigade HQ | Tank Bn (3x) | Mech Inf Bn (IFV) | SP Howitzer Bn (122-mm) | SP AA Gun Btry (23-mm) | Reconnaissance Co | Engineer Co | Signal Co | Chemical Defense Plt | Material Support Co | Maintenance Co | Medical Plt | TOTAL |
|--|------------|--------------|-------------------|-------------------------|------------------------|-------------------|-------------|-----------|----------------------|---------------------|----------------|-------------|-------|
| <b>TRUCKS</b>  |            |              |                   |                         |                        |                   |             |           |                      |                     |                |             |       |
| Truck, Utility   | 3          |              | 4                 |                         |                        |                   | 4           | 5         |                      | 2                   | 1              |             | 19    |
| Truck, Light   |            |              | 13                | 4                       | 1                      |                   |             | 3         |                      | 4                   |                | 1           | 26    |
| Truck, Medium  | 1          | 21           | 4                 | 14                      | 4                      |                   | 33          |           |                      | 30                  | 2              | 2           | 111   |
| Truck, Crane   |            |              |                   |                         |                        |                   | 1           |           |                      |                     |                |             | 1     |
| Truck, Crane Shovel  |            |              |                   |                         |                        |                   | 1           |           |                      |                     |                |             | 1     |
| Truck, Decon, ARS-12U/14   |            |              |                   |                         |                        |                   |             |           | 3                    |                     |                |             | 3     |
| Truck, Decon, DDA-53/66  |            |              |                   |                         |                        |                   |             |           | 1                    |                     |                | 1           | 2     |
| Truck, Dump  |            |              |                   |                         |                        |                   | 2           |           |                      |                     |                |             | 2     |
| Truck, POL (5,000-L)   |            | 9            | 2                 | 2                       |                        |                   |             |           |                      | 10                  |                |             | 23    |
| Truck, Water (2,000-L)   |            |              |                   |                         |                        |                   |             |           | 2                    | 3                   |                |             | 5     |
| Van, Command   | 3          |              |                   |                         |                        |                   |             |           |                      |                     |                |             | 3     |
| Van, Hospital  |            |              |                   |                         |                        |                   |             |           |                      |                     |                | 1           | 1     |
| Van, Kitchen   |            | 3            | 1                 |                         |                        |                   |             |           |                      |                     |                |             | 4     |
| Van, Maintenance   |            | 3            | 1                 | 2                       |                        |                   | 1           |           |                      | 1                   | 9              |             | 17    |
| Van, Signal  |            |              | 1                 | 4                       |                        |                   |             | 2         |                      |                     |                |             | 7     |
| Ambulance  |            | 3            | 1                 | 1                       |                        |                   |             |           |                      |                     |                | 4           | 9     |
| <b>TRAILERS</b>  |            |              |                   |                         |                        |                   |             |           |                      |                     |                |             |       |
| Trailer, Cargo, 1-Axle   |            | 3            | 2                 |                         |                        |                   | 6           |           |                      |                     |                |             | 11    |
| Trailer, Cargo, 2-Axle   |            | 18           |                   | 16                      |                        |                   | 2           |           |                      | 20                  | 6              |             | 62    |
| Trailer, Generator   |            | 3            | 1                 | 2                       | 2                      |                   |             | 1         |                      | 1                   | 3              |             | 13    |
| Trailer, Kitchen   |            |              | 3                 | 3                       |                        |                   | 1           |           |                      | 2                   |                | 1           | 10    |
| Trailer, POL (4,200-L)   |            | 9            | 3                 | 2                       |                        |                   |             |           |                      | 10                  |                |             | 24    |
| Trailer, Water (900-/1,200-L)                                      |            | 3            | 1                 | 1                       |                        |                   | 1           |           | 2                    | 1                   |                | 1           | 10    |
| <b>RADARS</b>  |            |              |                   |                         |                        |                   |             |           |                      |                     |                |             |       |
| Radar, Battlefield Surveillance, Man-Portable, PSNR-1 or TALL MIKE |            |              |                   |                         |                        | 1                 |             |           |                      |                     |                |             | 1     |
| <b>RADIOS</b>  |            |              |                   |                         |                        |                   |             |           |                      |                     |                |             |       |
| VHF, Manpack, Low-Power  | 2          | 3            | 16                | 10                      |                        | 4                 | 4           | 7         |                      | 1                   | 1              | 1           | 49    |
| VHF, Portable, Low-Power   |            |              | 22                |                         | 1                      | 5                 |             |           |                      |                     |                |             | 28    |
| VHF, Portable, Very-Low-Power                                      |            |              | 4                 |                         |                        |                   |             |           |                      |                     |                |             | 4     |
| VHF, Vehicle Mount, Medium-Power                                   | 3          | 24           | 44                | 27                      | 9                      | 8                 | 8           | 8         | 3                    |                     | 3              |             | 137   |
| HF, Manpack, Low-Power   |            | 6            |                   |                         |                        |                   |             | 2         | 1                    |                     |                |             | 9     |
| HF, Vehicle Mount, Medium-Power                                    | 1          | 15           | 2                 |                         |                        | 1                 | 1           | 2         |                      |                     |                |             | 22    |
| HF/VHF, Vehicle Mount, Med-Power                                   |            |              | 1                 | 4                       |                        |                   |             | 2         |                      |                     |                |             | 7     |
| HF/VHF, Vehicle Mount, High-Power                                  |            |              |                   |                         |                        |                   |             | 2         |                      |                     |                |             | 2     |
| HF, Vehicle Mount, High-Power                                      |            |              |                   |                         |                        |                   |             | 1         |                      |                     |                |             | 1     |
| Radio Relay, VHF/UHF   |            |              |                   |                         |                        |                   |             | 2         |                      |                     |                |             | 2     |
| Warning Receiver   | 1          | 3            | 1                 | 2                       | 3                      | 1                 |             | 3         |                      |                     |                |             | 14    |
| <b>MISCELLANEOUS</b>   |            |              |                   |                         |                        |                   |             |           |                      |                     |                |             |       |
| Rangefinder, Laser, SAGE GLOSS                                     |            |              |                   | 4                       |                        |                   |             |           |                      |                     |                |             | 4     |
| Rangefinder, Stereoscopic  |            |              | 1                 |                         |                        |                   |             |           |                      |                     |                |             | 1     |
| Periscopic Aiming Circle   |            |              | 1                 |                         |                        |                   |             |           |                      |                     |                |             | 1     |
| Collimator   |            |              | 6                 |                         |                        |                   |             |           |                      |                     |                |             | 6     |
| Motorcycle   |            |              |                   |                         |                        | 3                 |             | 3         |                      |                     |                |             | 6     |

**Tank Battalion (22-Tank Variant),  
Tank Bde (67-Tank Variant)**

---

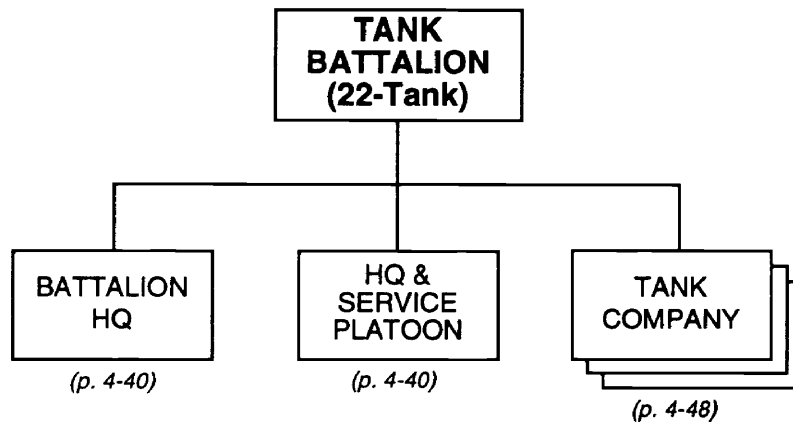

**PRINCIPAL ITEMS OF EQUIPMENT**

| <u>Equipment</u>                                 | <u>Total</u> | <u>Equipment</u>                         | <u>Total</u> |
|--|--------------|--|--------------|
| Medium Tank, T-55K/62K<br>(Command Vehicle)..... | 1            | Trailer, Cargo, 2-Axle.....              | 6            |
| Medium Tank, T-55/62.....                        | 21           | Trailer, Generator.....                  | 1            |
| ACV, BMP-1K/2K.....                              | 1            | Trailer, POL (4,200-Liter).....          | 3            |
| ACV, BTR (R-145BM)*.....                         | 1            | Trailer, Water (900-Liter).....          | 1            |
| 9-mm Pistol, PM.....                             | 77           | Night-Vision Goggles.....                | 2            |
| 5.45-mm Assault Rifle,<br>AKS-74/AK-74.....      | 42           | Night-Vision Sight (Small Arms).....     | 6            |
| ATGL, RPG-7V.....                                | 2            | Radios:                                  |              |
| Truck, Medium.....                               | 7            | VHF, Manpack, Low-Power.....             | 1            |
| Truck, POL (5,000-Liter).....                    | 3            | VHF, Vehicle Mount,<br>Medium-Power..... | 24           |
| Van, Kitchen.....                                | 1            | HF, Manpack, Low-Power.....              | 2            |
| Van, Maintenance.....                            | 1            | HF, Vehicle Mount,<br>Medium-Power.....  | 5            |
| Ambulance.....                                   | 1            | Warning Receiver.....                    | 1            |
| Trailer, Cargo, 1-Axle.....                      | 1            |  |              |

**FOOTNOTE:** \* In some tank battalions, the tracked ACV, BMP-1KSh may replace the wheeled ACV, BTR (R-145BM).

**Tank Company (7-Tank Variant), Tank Bn (22-Tank Variant)  
or Separate Tank Bn**

---

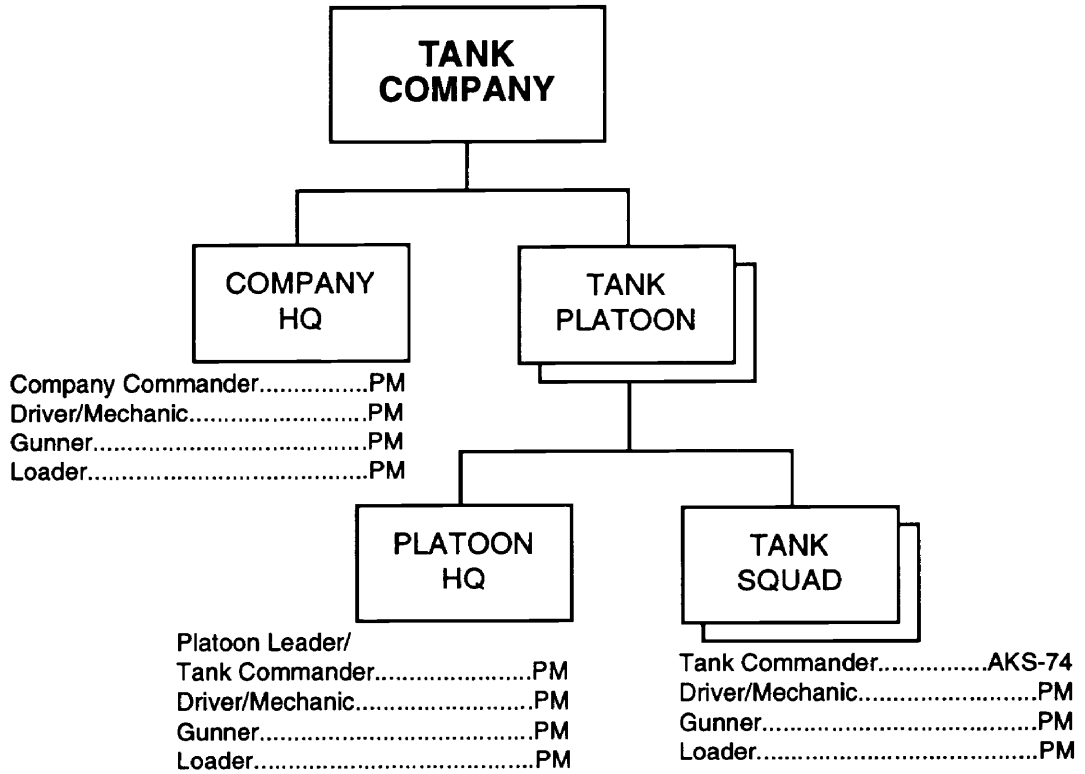

**PRINCIPAL ITEMS OF EQUIPMENT**

| <u>Equipment</u>                    | <u>Total</u> |
|-------------------------------------|--------------|
| Medium Tank, T-55/62.....           | 7            |
| 9-mm Pistol, PM.....                | 24           |
| 5.45-mm Assault Rifle, AKS-74 ..... | 4            |

| <u>Equipment</u>                          | <u>Total</u> |
|---|--------------|
| Radios:                                   |              |
| VHF, Vehicle Mount,<br>Medium-Power ..... | 7            |
| HF, Vehicle Mount,<br>Medium-Power .....  | 1            |



# Chapter 5

## Operational- and Strategic-Level Ground Forces

The Ground Forces are the largest branch of the armed forces. Their tactical maneuver units (described in Chapters 1 through 4) are subordinate to military regions. These regions, or an expeditionary army which could form in one region, constitute the *operational* level of forces. The Ground Forces also have a national asset pool (described in Chapter 6). The General Staff/Ground Forces Headquarters can use this pool of combat support and combat service support units to tailor support to military regions. The Capital Defense Forces, aside from protecting the national capital, can serve as a *strategic reserve*. The Ground Forces may include an airborne infantry brigade. This airborne force is a *strategic* asset which remains under the direct control of the General Staff/Ground Forces Headquarters.

### CONTENTS

|   |      |
|---|------|
| <b>Ground Forces</b> .....  | 5-2  |
| <b>Military Region</b> .....  | 5-3  |
| <b>Expeditionary Army</b> .....   | 5-5  |
| <b>Capital Defense Forces (Example)</b> .....   | 5-6  |
| <b>Airborne Infantry Brigade</b> .....  | 5-7  |
| Brigade Headquarters, Abn Inf Bde.....  | 5-9  |
| Airborne Infantry Battalion, Abn Inf Bde.....   | 5-10 |
| Battalion Headquarters, Abn Inf Bn .....  | 5-11 |
| Airborne Infantry Company, Abn Inf Bn.....  | 5-11 |
| Airborne Infantry Platoon, Abn Inf Co.....  | 5-12 |
| Airborne Infantry Squad, Abn Inf Plt .....  | 5-13 |
| Mortar Battery, Abn Inf Bn or Composite Arty Bn.....                                  | 5-14 |
| SAM Platoon, Abn Inf Bn or Wpns Co, Commando Bn.....                                  | 5-15 |
| ATGM Platoon, Abn Inf Bn .....  | 5-16 |
| Automatic Grenade Launcher Platoon, Abn Inf Bn or Wpns Co, Commando Bn .....          | 5-17 |
| Automatic Grenade Launcher Squad, AGL Plt, Abn Inf Bn<br>or Wpns Co, Commando Bn..... | 5-17 |
| Engineer Platoon, Abn Inf Bn.....   | 5-18 |
| Signal Platoon, Abn Inf Bn.....   | 5-19 |
| Materiel Support Platoon, Abn Inf Bn.....   | 5-19 |
| Medical Section, Abn Inf Bn .....   | 5-20 |
| Composite Artillery Battalion, Abn Inf Bde.....                                       | 5-21 |
| 122-mm Howitzer Battery, Composite Arty Bn, Abn Inf Bde .....                         | 5-22 |
| Antitank Platoon, Abn Inf Bde .....   | 5-23 |
| Reconnaissance Company, Abn Inf Bde.....  | 5-24 |
| Engineer Company, Abn Inf Bde.....  | 5-25 |

Signal Company, Abn Inf Bde ..... 5-26  
 Chemical Defense Platoon, Abn Inf Bde ..... 5-27  
 Materiel Support Company, Abn Inf Bde ..... 5-27  
 Maintenance Company, Abn Inf Bde ..... 5-28  
 Medical Platoon, Abn Inf Bde ..... 5-28

**Ground Forces** \_\_\_\_\_

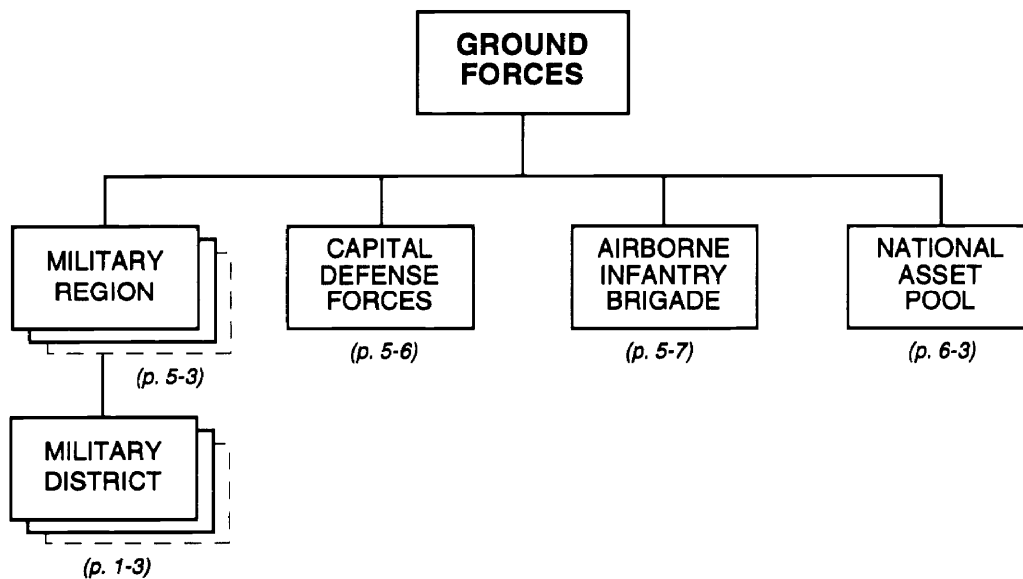

**NOTES:**

1. The Ground Forces are the largest branch of the armed forces. Most maneuver units are subordinate to military districts which in turn are subordinate to the military regions. These units, along with the national asset pool, comprise the bulk of the Ground Forces.
2. Compared with the rest of the Ground Forces, the Capital Defense Forces are fewer in number. They also have more narrowly defined missions and methods of employment.
3. The national asset pool is actually a pool of Ground Forces assets. It contains no maneuver forces but rather a variety of combat support and combat service support assets. The General Staff/Ground Forces Headquarters can allocate or reallocate these assets as the situation requires.

## Military Region

Military regions are *geographical* entities that delineate territorial responsibilities and disposition of the State's armed forces. Each region has a number of subordinate military districts. The number varies from two to four districts. Three districts is the norm. Unless a region serves as the basis for an expeditionary army (p. 5-5), all maneuver units in a region are subordinate to the districts. A typical region has few organic combat support and combat service support assets other than those that belong to districts.

All other units present in a region come from the *national asset pool*, the Air Defense Command, or the Directorate of Military Intelligence. The number and types of such units can vary widely from region to region, depending on a region's size and mission. Therefore, the following organization chart merely outlines the types of units that might or might not be present in a given region.

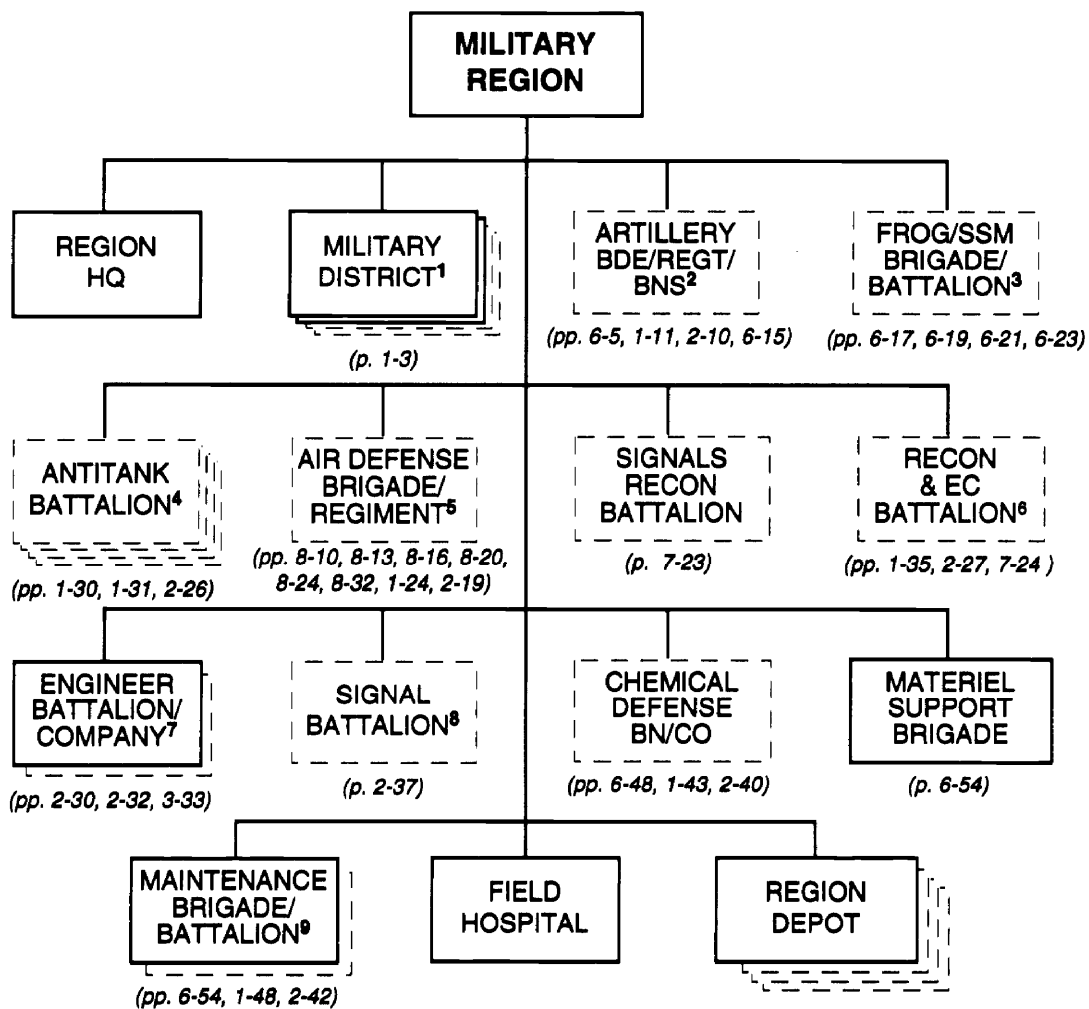

(continued)

Military Region (continued)

---

**FOOTNOTES:**

- <sup>1</sup> Not all military districts within a region have the same composition. For example, a region could have two districts composed of separate brigades and one district with a standing division composed of divisional brigades.
- <sup>2</sup> The region has no organic artillery at region level. Depending on its mission, it receives tube artillery and MRL units ranging from single battalions to regiments and brigades. The region may or may not retain some of these national assets to form a military region artillery group (MRAG). It normally suballocates most artillery assets to subordinate districts for the formation of military district artillery groups (MDAGs) and/or division artillery groups (DAGs) and brigade artillery groups (BrAGs).
- <sup>3</sup> The General Staff may allocate an SSM brigade, or individual SSM battalions, from the national asset pool to a military region. However, these strategic assets always remain under General Staff control. The General Staff also controls a FROG rocket brigade or battalion allocated to a region conducting the main effort.
- <sup>4</sup> A region may suballocate these national-level antitank assets to subordinate military districts.
- <sup>5</sup> The national-level Air Defense Command may allocate some of its more mobile SAM units to a military region. These units may include regiments of low-to-medium-altitude SAMs (SA-6 or SA-8) or possibly portions of brigades of medium-to-high-altitude SAMs (SA-4 or SA-11).
- <sup>6</sup> A region may receive a reconnaissance and EC battalion from the Directorate of Military Intelligence. Although the region can retain this battalion under its own control, it can also allocate the battalion to support a subordinate military district.
- <sup>7</sup> Most regions have an organic engineer battalion or company. These units are primarily combat engineers. Regions must rely on national assets for specialized engineer support such as pontoon bridge and assault crossing battalions. A high-priority region may receive an engineer brigade (p. 6-26) from the national asset pool. In that case, the region would retain the specialized engineer battalions at region level and suballocate the combat engineer battalion(s) to subordinate districts or divisions.
- <sup>8</sup> Most regions have organic signal organizations. In wartime, a region without signal organizations normally receives a signal battalion from the national asset pool.
- <sup>9</sup> A region logistics base normally includes one or more maintenance brigades from the national asset pool in wartime.

## Expeditionary Army

The OPFOR is capable of fielding one expeditionary army, composed of mobile divisions and/or brigades, for conducting large-scale extraterritorial offensive operations. An expeditionary army is a joint command and is the integration point for ground, air, naval, and special operations forces. The commander of the region in which the army forms becomes the army commander. The region headquarters becomes the army headquarters.

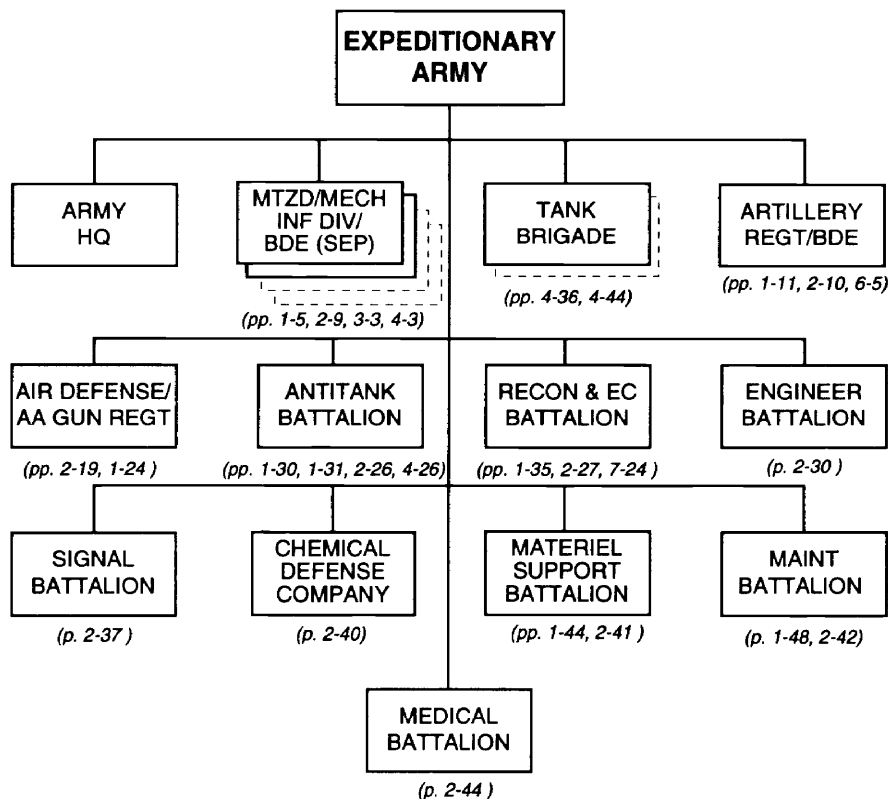

### NOTES:

1. The army may comprise three to five mobile divisions, which come from three basic sources: standing divisions, divisions formed using restructured separate mechanized or motorized infantry brigades as a maneuver base, and divisions mobilized from the reserves. Standing divisions may come from within the region's subordinate districts or from another region at the direction of the General Staff/Ground Forces Headquarters. Districts composed of separate brigades may restructure them as divisional brigades, then receive division-level assets from the national asset pool, through the controlling region. Units composing a reserve division mobilize from within the region's subordinate districts.
2. The army could include separate mechanized or motorized infantry brigades or tank brigades directly subordinate to the army commander. These brigades could come from a subordinate district's forces, from another region at the direction of the General Staff/Ground Forces Headquarters, or from mobilized reserves. An organization consisting primarily of brigades, with no more than one division, may bear the designation *corps* rather than army.
3. Most of the army-level combat support and combat service support assets come from the national asset pool. The General Staff/Ground Forces Headquarters uses these assets to tailor the army for its special offensive mission.

Capital Defense Forces (Example)

The Capital Defense Forces (CDF), garrisoned in the Capital District, are typically the best-equipped in the country. Their primary mission is to defend the State's national capital. However, they also serve as a strategic reserve. Composition of these forces is **subject to change**, depending on conditions and plans. Therefore, the following organization chart is merely an **example** of possible forces. In this example, the maneuver brigades in dashed boxes could serve as the strategic reserve, while the other units defend the capital.

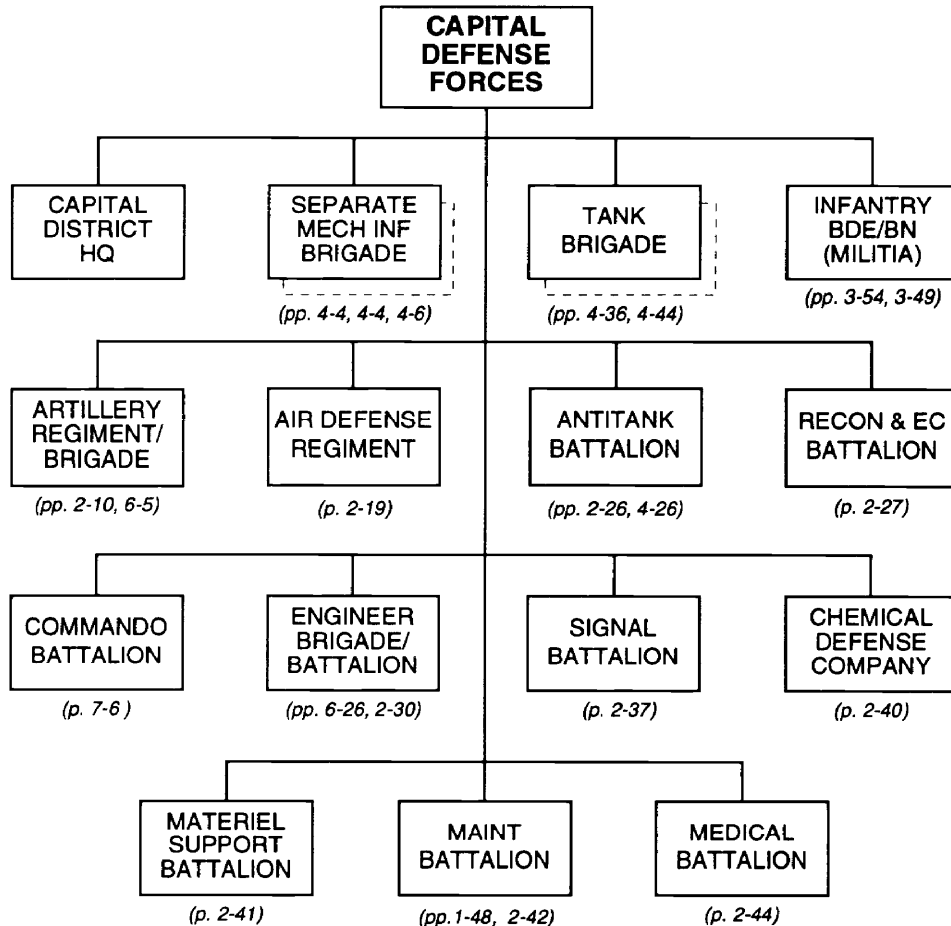

NOTES:

1. Since the inception of the CDF, their composition has changed several times. At times, the Capital District has included a standing mechanized infantry division. However, the most common structure has been a specially tailored force composed of separate brigades (as shown above). Depending on the number of brigades, such a force can be more robust than a standard division. It also has greater flexibility and mobility.
2. Whether based on a division or separate brigades, the CDF normally have a full complement of combat support and combat service support assets resembling that shown above.

## Airborne Infantry Brigade

The Ground Forces may include an airborne infantry brigade. The General Staff/Ground Forces Headquarters holds this brigade as a strategic asset. It may employ the brigade, or one or two airborne infantry battalions from it, to support an operation conducted by a military region or an expeditionary army. However, it never allocates this brigade to them in the same manner that it does with other forces.

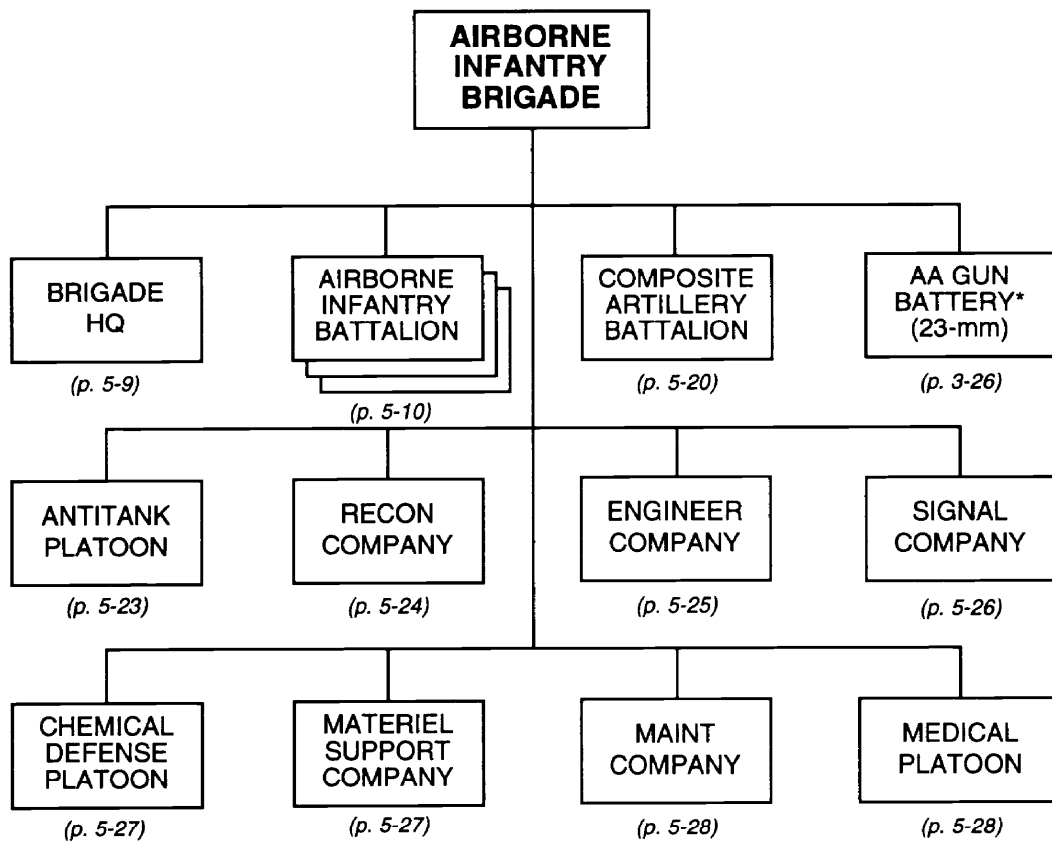

**FOOTNOTE:** \* An airborne infantry brigade may not always have this battery of 23-mm AA guns. However, it always has some type of battery-sized air defense unit. It can have a battery of 14.5-mm AA heavy machineguns (p. 2-5) or a battery of three shoulder-fired SAM platoons (p. 5-15). It can also have any mix of three platoons from those three types of air defense units.

(continued)

Airborne Infantry Brigade (continued)

| Principal Items of Equipment                                       | Brigade HQ | Abn Inf Bn (3x) | Composite Arty Bn | AA Gun Btry | Antitank Plt | Recon Co | Engineer Co | Signal Co | Chem Defense Plt | Matériel Spt Co | Maintenance Co | Medical Plt | TOTAL |
|--|------------|-----------------|-------------------|-------------|--------------|----------|-------------|-----------|------------------|-----------------|----------------|-------------|-------|
| <b>ARMORED VEHICLES</b>  |            |                 |                   |             |              |          |             |           |                  |                 |                |             |       |
| ACV, BRDM-2U   |            |                 |                   |             |              | 1        |             |           |                  |                 |                |             | 1     |
| ASC, BRDM-2  |            |                 |                   |             |              | 8        |             |           |                  |                 |                |             | 8     |
| <b>WEAPONS</b>   |            |                 |                   |             |              |          |             |           |                  |                 |                |             |       |
| 30-mm Auto Grenade Launcher, AGS-17                                |            | 18              |                   |             |              |          |             |           |                  |                 |                |             | 18    |
| 82-mm Mortar M1937/2B9   |            | 18              |                   |             |              |          |             |           |                  |                 |                |             | 18    |
| 120-mm Mortar, M1943<br>or 82-mm Mortar M1937/2B9                  |            |                 | 6                 |             |              |          |             |           |                  |                 |                |             | 6     |
| 122-mm Howitzer, D-30  |            |                 | 6                 |             |              |          |             |           |                  |                 |                |             | 6     |
| 140-mm Multiple Rocket Launcher, RPU-14                            |            |                 | 6                 |             |              |          |             |           |                  |                 |                |             | 6     |
| 73-mm Recoilless Gun, SPG-9  |            |                 |                   |             | 3            |          |             |           |                  |                 |                |             | 3     |
| ATGM Manpack, AT-4/SPIGOT  |            | 18              |                   |             | 6            |          |             |           |                  |                 |                |             | 24    |
| ATGM Manpack, AT-7/SAXHORN   |            | 27              |                   |             |              |          |             |           |                  |                 |                |             | 27    |
| 23-mm AA Gun, ZU-23  |            |                 |                   | 8           |              |          |             |           |                  |                 |                |             | 8     |
| SAM, Shoulder-Fired  | 3          | 39              | 6                 |             |              |          |             |           |                  |                 |                |             | 48    |
| Flamethrower, LPO/RPO  |            | 33              |                   |             |              |          | 4           |           |                  |                 |                |             | 37    |
| <b>TRUCKS</b>  |            |                 |                   |             |              |          |             |           |                  |                 |                |             |       |
| Truck, Utility   | 7          | 27              | 11                | 1           | 1            |          | 1           | 8         |                  | 2               | 2              |             | 60    |
| Truck, Light   |            | 72              | 26                | 8           | 5            |          | 18          |           |                  | 30              |                | 2           | 161   |
| Truck, Chem Recon, UAZ-69RKh                                       |            |                 |                   |             |              |          |             |           | 4                |                 |                |             | 4     |
| Truck, POL (4,000-L)   |            | 3               | 1                 |             |              |          |             |           |                  | 8               |                |             | 12    |
| ACRV, 1V110 (Battery FDC)  |            |                 | 2                 |             |              |          |             |           |                  |                 |                |             | 2     |
| Van, Maintenance   |            | 3               | 1                 |             |              |          |             |           |                  | 1               | 9              |             | 14    |
| Van, Signal  |            | 3               | 2                 |             |              |          |             | 3         |                  |                 |                |             | 8     |
| Ambulance  |            | 3               | 1                 |             |              |          |             |           |                  |                 |                | 4           | 8     |
| <b>TRAILERS</b>  |            |                 |                   |             |              |          |             |           |                  |                 |                |             |       |
| Trailer, Cargo, 1-Axle   | 3          | 6               | 7                 |             |              |          |             |           |                  | 26              | 4              |             | 46    |
| Trailer, Generator   |            | 3               | 1                 |             |              |          |             | 1         |                  | 1               | 2              |             | 8     |
| Trailer, Kitchen   |            | 9               | 3                 |             |              |          | 1           | 1         |                  | 2               | 1              | 1           | 18    |
| Trailer, POL (1,200-L)   |            | 9               | 1                 |             |              |          |             |           |                  | 8               |                |             | 18    |
| Trailer, Water (900-L)   |            | 6               | 1                 |             |              |          | 1           |           |                  | 1               | 1              | 1           | 11    |
| <b>RADARS</b>  |            |                 |                   |             |              |          |             |           |                  |                 |                |             |       |
| Radar, Battlefield Surveillance, Man-Portable, PSNR-1 or TALL MIKE |            |                 | 1                 |             | 1            | 2        |             |           |                  |                 |                |             | 4     |
| <b>RADIOS</b>  |            |                 |                   |             |              |          |             |           |                  |                 |                |             |       |
| VHF, Manpack, Low-Power  | 1          | 105             | 13                | 3           | 4            |          | 6           |           |                  | 3               | 1              | 2           | 138   |
| VHF, Portable, Low-Power   |            | 96              | 2                 |             | 7            | 13       | 4           |           |                  |                 |                |             | 122   |
| VHF, Portable, Very-Low-Power                                      |            | 51              | 14                |             |              |          |             |           |                  |                 |                |             | 65    |
| VHF, Vehicle Mount, Medium-Power                                   |            |                 | 2                 |             |              | 9        |             |           | 4                |                 |                |             | 15    |
| HF, Manpack, Low-Power   |            |                 |                   |             |              | 1        |             |           | 1                |                 |                |             | 2     |
| HF, Vehicle Mount, Medium-Power                                    |            |                 |                   |             |              | 1        |             |           |                  |                 |                |             | 1     |
| HF/VHF, Manpack, Low-Power   |            |                 |                   |             |              |          |             | 6         |                  |                 |                |             | 6     |
| HF/VHF, Vehicle Mount, Med-Power                                   | 8          | 3               | 3                 |             |              |          |             | 3         |                  |                 |                |             | 17    |
| HF/VHF, Vehicle Mount, High-Power                                  |            |                 |                   |             |              |          |             | 1         |                  |                 |                |             | 1     |
| Ground-to-Air Radio Set  | 2          | 3               |                   |             |              |          |             | 1         |                  |                 |                |             | 6     |
| Burst-Transmission   | 2          | 15              |                   |             |              | 3        |             |           |                  |                 |                |             | 20    |
| Warning Receiver   | 1          | 6               | 1                 | 1           |              | 1        |             | 1         |                  |                 |                |             | 11    |
| <b>ENGINEER EQUIPMENT</b>  |            |                 |                   |             |              |          |             |           |                  |                 |                |             |       |
| Mine Detector, DIM   |            | 3               |                   |             |              |          | 2           |           |                  |                 |                |             | 5     |
| Demolition Set   |            | 9               |                   |             |              |          | 6           |           |                  |                 |                |             | 15    |
| Airdroppable Bridge, PVD-20/DPP-40                                 |            |                 |                   |             |              |          | 10          |           |                  |                 |                |             | 10    |
| <b>MISCELLANEOUS</b>   |            |                 |                   |             |              |          |             |           |                  |                 |                |             |       |
| Rangefinder, Steroscopic   |            |                 | 1                 |             |              |          |             |           |                  |                 |                |             | 1     |
| Rangefinder, Laser, SAGE GLOSS                                     |            |                 | 1                 |             |              |          |             |           |                  |                 |                |             | 1     |
| Periscopic Aiming Circle   |            |                 | 1                 |             |              |          |             |           |                  |                 |                |             | 1     |
| Collimator   |            |                 | 6                 |             |              |          |             |           |                  |                 |                |             | 6     |
| Motorcycle   |            |                 |                   |             |              | 9        |             | 3         |                  |                 |                |             | 12    |



Brigade Headquarters, Abn Inf Bde \_\_\_\_\_

|                                 |
|---------------------------------|
| <b>BRIGADE<br/>HEADQUARTERS</b> |
|---------------------------------|

**PRINCIPAL ITEMS OF EQUIPMENT**

| <u>Equipment</u>            | <u>Total</u> | <u>Equipment</u>             | <u>Total</u> |
|-----------------------------|--------------|------------------------------|--------------|
| SAM, Shoulder-Fired*.....   | 3            | Radios:                      |              |
| ATGL, RPG-16D.....          | 2            | VHF, Manpack, Low-Power..... | 1            |
| Truck, Utility .....        | 7            | HF/VHF, Vehicle Mount,       |              |
| Trailer, Cargo, 1-Axle..... | 3            | Medium-Power .....           | 8            |
|                             |              | Ground-to-Air Set.....       | 2            |
|                             |              | Burst Transmission .....     | 2            |
|                             |              | Warning Receiver .....       | 1            |

**FOOTNOTE:** \* Some brigade headquarters may have one to two 12.7-mm DShK machineguns, instead of the shoulder-fired SAMs.

Airborne Infantry Battalion, Abn Inf Bde

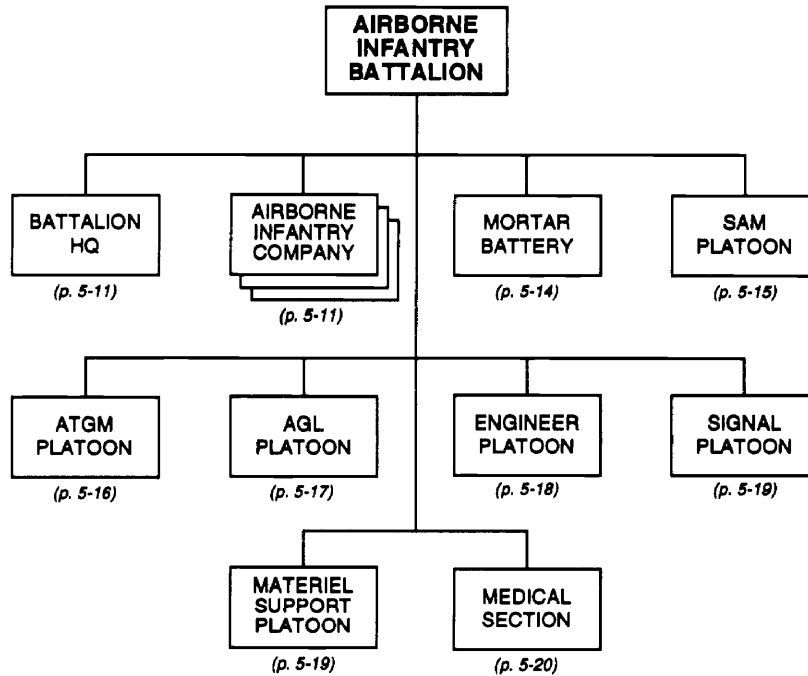

PRINCIPAL ITEMS OF EQUIPMENT

| <u>Equipment</u>                                   | <u>Total</u> |
|--|--------------|
| 9-mm Pistol, PM.....                               | 133          |
| 5.45-mm Assault Rifle, AKS-74 .....                | 356          |
| 5.45-mm LMG, RPKS-74.....                          | 30           |
| 7.62-mm Sniper Rifle, SVD .....                    | 27           |
| 7.62-mm GP MG, PKM.....                            | 27           |
| 40-mm Under-Barrel Grenade Launcher,<br>BG-15..... | 78           |
| 30-mm Automatic Grenade Launcher,<br>AGS-17 .....  | 6            |
| 82-mm Mortar, M1937/2B9 .....                      | 6            |
| SAM, Shoulder-Fired.....                           | 13           |
| ATGM Manpack, AT-4/SPIGOT .....                    | 6            |
| ATGM Manpack, AT-7/SAXHORN.....                    | 9            |
| ATGL, RPG-16D.....                                 | 52           |
| ATRL, RPG-18/22.....                               | 9            |
| Flamethrower, LPO/RPO.....                         | 11           |
| Truck, Utility .....                               | 9            |
| Truck, Light .....                                 | 24           |
| Truck, POL (4,000-Liter).....                      | 1            |
| Van, Maintenance .....                             | 1            |
| Van, Signal.....                                   | 1            |
| Ambulance .....                                    | 1            |
| Trailer, Cargo, 1-Axle.....                        | 2            |

| <u>Equipment</u>  | <u>Total</u> |
|---|--------------|
| Trailer, Generator.....                                 | 1            |
| Trailer, Kitchen.....                                   | 3            |
| Trailer, POL (1,200-Liter) .....                        | 3            |
| Trailer, Water (900-Liter) .....                        | 2            |
| Mine Detector, DIM.....                                 | 1            |
| Demolition Set.....                                     | 3            |
| Night-Vision Goggles .....                              | 47           |
| Night-Vision Goggles (Driver) .....                     | 66           |
| Night-Vision Sight (Small Arms) .....                   | 79           |
| Night-Vision Sight (MG).....                            | 18           |
| Rangefinder, Stereoscopic, DS-1<br>or DM-09/DAK-1 ..... | 1            |
| Periscopic Aiming Circle, PAB2A .....                   | 1            |
| Collimator .....  | 6            |
| Radios:   |              |
| VHF, Manpack, Low-Power.....                            | 35           |
| VHF, Portable, Low-Power .....                          | 32           |
| VHF, Portable, Very-Low-Power .....                     | 17           |
| HF/VHF, Vehicle Mount,<br>Medium-Power .....            | 1            |
| Ground-to-Air Set.....                                  | 1            |
| Burst Transmission .....                                | 5            |
| Warning Receiver .....                                  | 2            |

Battalion Headquarters, Abn Inf Bn \_\_\_\_\_

**BATTALION  
HEADQUARTERS**

**PRINCIPAL ITEMS OF EQUIPMENT**

| <u>Equipment</u>                     | <u>Total</u> | <u>Equipment</u>                    | <u>Total</u> |
|--------------------------------------|--------------|-------------------------------------|--------------|
| 9-mm Pistol, PM.....                 | 4            | Radios:                             |              |
| 5.45-mm Assault Rifle, AKS-74 .....  | 4            | VHF, Manpack, Low-Power.....        | 1            |
| ATGL, RPG-16D.....                   | 1            | VHF, Portable, Very-Low-Power ..... | 2            |
| SAM, Shouldered-Fired*.....          | 2            | Burst Transmission .....            | 1            |
| Night-Vision Goggles .....           | 2            | Warning Receiver .....              | 1            |
| Night-Vision Sight (Small Arms)..... | 2            |                                     |              |

**FOOTNOTE:** \* Some battalion headquarters have one to two 12.7-mm DShK machineguns, instead of the shoulder-fired SAMs.

Airborne Infantry Company, Abn Inf Bn \_\_\_\_\_

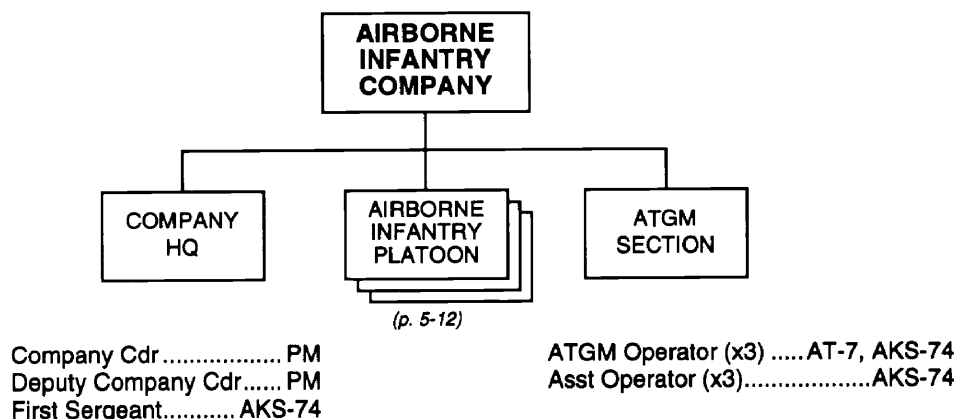

**PRINCIPAL ITEMS OF EQUIPMENT**

| <u>Equipment</u>                                   | <u>Total</u> | <u>Equipment</u>                     | <u>Total</u> |
|--|--------------|--------------------------------------|--------------|
| 9-mm Pistol, PM.....                               | 29           | Flamethrower, LPO/RPO.....           | 3            |
| 5.45-mm Assault Rifle, AKS-74 .....                | 64           | Night-Vision Goggles .....           | 15           |
| 5.45-mm LMG, RPKS-74.....                          | 9            | Night-Vision Sight (Small Arms)..... | 21           |
| 7.62-mm Sniper Rifle, SVD .....                    | 9            | Night-Vision Sight (MG).....         | 9            |
| 7.62-mm GP MG, PKM.....                            | 9            | Radios:                              |              |
| 40-mm Under-Barrel Grenade Launcher,<br>BG-15..... | 22           | VHF, Manpack, Low-Power.....         | 4            |
| ATGM Manpack, AT-7/SAXHORN.....                    | 3            | VHF, Portable, Low-Power .....       | 4            |
| ATGL, RPG-16D.....                                 | 15           | VHF, Portable, Very-Low-Power .....  | 9            |
|  |              | Burst Transmission .....             | 1            |

**Airborne Infantry Platoon,  
Abn Inf Co**

---

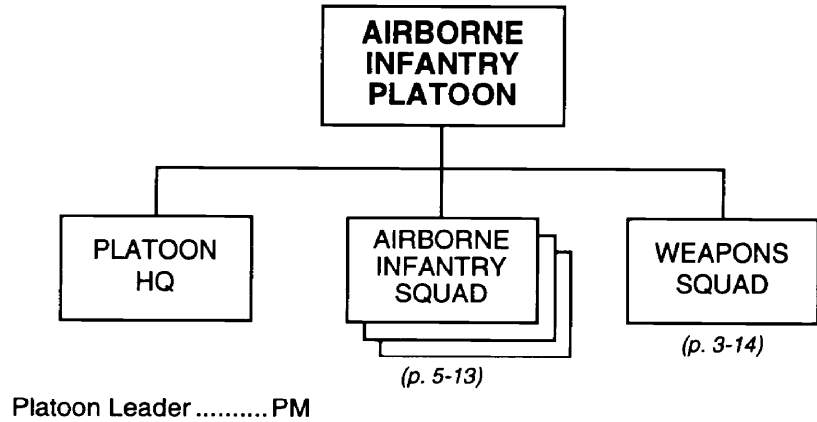

**PRINCIPAL ITEMS OF EQUIPMENT**

| <u>Equipment</u>                                   | <u>Total</u> | <u>Equipment</u>                     | <u>Total</u> |
|--|--------------|--------------------------------------|--------------|
| 9-mm Pistol, PM.....                               | 9            | Flamethrower, LPO/RPO.....           | 1            |
| 5.45-mm Assault Rifle, AKS-74 .....                | 19           | Night-Vision Goggles .....           | 5            |
| 5.45-mm LMG, RPKS-74.....                          | 3            | Night-Vision Sight (Small Arms)..... | 7            |
| 7.62-mm Sniper Rifle, SVD .....                    | 3            | Night-Vision Sight (MG).....         | 3            |
| 7.62-mm GP MG, PKM.....                            | 3            | Radios:                              |              |
| 40-mm Under-Barrel Grenade Launcher,<br>BG-15..... | 7            | VHF, Manpack, Low-Power.....         | 1            |
| ATGL, RPG-16D.....                                 | 5            | VHF, Portable, Low-Power .....       | 1            |
|  |              | VHF, Portable, Very-Low-Power .....  | 3            |

*NOTE:* One squad leader is also the assistant platoon leader.

**Airborne Infantry Squad,  
Abn Inf Plt**

---

|   |
|---|
| <p><b>AIRBORNE<br/>INFANTRY<br/>SQUAD</b></p> |
|---|

Squad Leader.....AKS-74  
 Machinegunner..... RPKS-74  
 Grenadier ..... RPG-16D/PM  
 Asst Grenadier .....AKS-74  
 Asst Squad Leader/  
     Senior Rifleman.....AKS-74  
 Rifleman (x2) .....AKS-74  
 Sniper ..... SVD

**PRINCIPAL ITEMS OF EQUIPMENT**

| <u>Equipment</u>                    | <u>Total</u> |
|-------------------------------------|--------------|
| 9-mm Pistol, PM.....                | 1            |
| 5.45-mm Assault Rifle, AKS-74 ..... | 5            |
| 5.45-mm LMG, RPKS-74.....           | 1            |
| 7.62-mm Sniper Rifle, SVD .....     | 1            |
| ATGL, RPG-16D.....                  | 1            |

| <u>Equipment</u>                                   | <u>Total</u> |
|--|--------------|
| 40-mm Under Barrel-Grenade Launcher,<br>BG-15..... | 2            |
| Night-Vision Goggles .....                         | 1            |
| Night-Vision Sight (Small Arms).....               | 2            |
| Radio, VHF, Portable,<br>Very-Low-Power .....      | 1            |

Mortar Battery, Abn Inf Bn or  
Composite Arty Bn \_\_\_\_\_

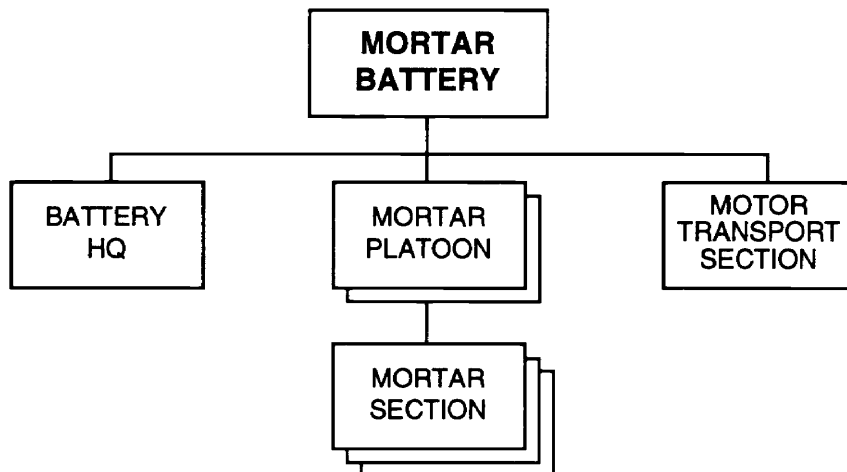

**PRINCIPAL ITEMS OF EQUIPMENT**

| <u>Equipment</u>                                   | <u>Total</u> | <u>Equipment</u>                      | <u>Total</u> |
|--|--------------|---------------------------------------|--------------|
| 82-mm Mortar, M1937/2B9* .....                     | 6            | Rangefinder, Stereoscopic, DS-1 ..... | 1            |
| 9-mm Pistol, PM.....                               | 14           | Periscopic Aiming Circle, PAB2A ..... | 1            |
| 5.45-mm Assault Rifle, AKS-74 .....                | 47           | Collimator .....                      | 6            |
| 7.62-mm GP MG, PKM.....                            | 2            | Night-Vision Goggles .....            | 2            |
| 40-mm Under Barrel-Grenade Launcher,<br>BG-15..... | 6            | Night-Vision Goggles (Driver) .....   | 6            |
| ATGL, RPG-16D.....                                 | 3            | Night-Vision Sight (Small Arms) ..... | 6            |
| Truck, Utility .....                               | 7            | Radio, VHF, Manpack, Low-Power .....  | 6            |

**FOOTNOTE:** \* In the composite artillery battalion, this mortar battery may have the 120-mm mortar M1943 rather than the 82-mm mortar.

**SAM Platoon, Abn Inf Bn or Wpns Co,  
Commando Bn**

---

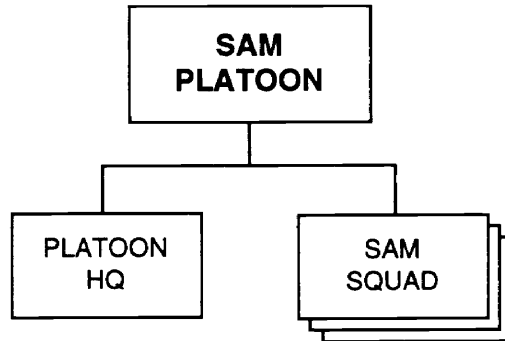

**PRINCIPAL ITEMS OF EQUIPMENT**

| <u>Equipment</u>                    | <u>Total</u> |
|-------------------------------------|--------------|
| SAM, Shoulder-Fired.....            | 9            |
| 9-mm Pistol, PM.....                | 4            |
| 5.45-mm Assault Rifle, AKS-74 ..... | 9            |
| Truck, Light .....                  | 3            |

| <u>Equipment</u>                              | <u>Total</u> |
|---|--------------|
| Night-Vision Goggles .....                    | 1            |
| Night-Vision Goggles (Driver) .....           | 3            |
| Radio, VHF, Portable,<br>Very-Low-Power ..... | 4            |

ATGM Platoon,  
Abn Inf Bn

---

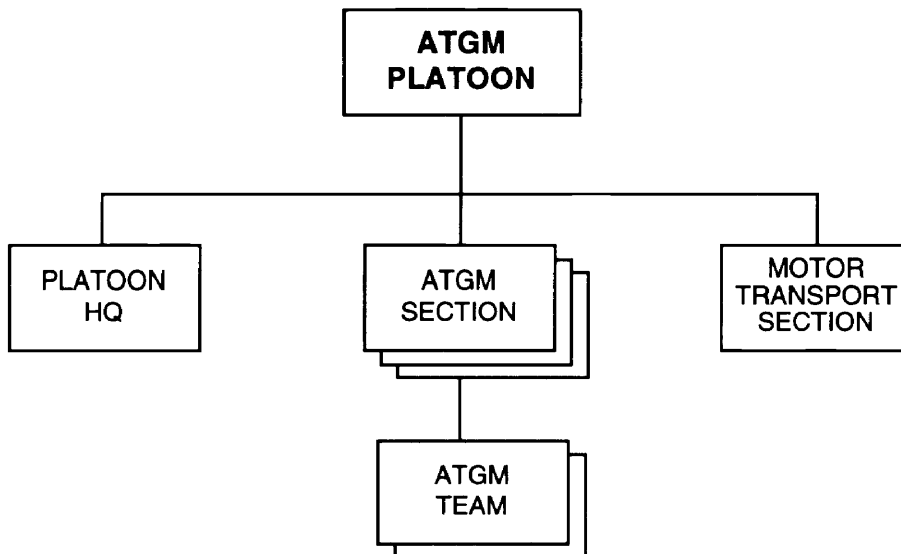

**PRINCIPAL ITEMS OF EQUIPMENT**

| <u>Equipment</u>                                   | <u>Total</u> |
|--|--------------|
| ATGM Manpack, AT-4/SPIGOT .....                    | 6            |
| 9-mm Pistol, PM.....                               | 11           |
| 5.45-mm Assault Rifle, AKS-74 .....                | 19           |
| 40-mm Under-Barrel Grenade Launcher,<br>BG-15..... | 6            |
| ATRL, RPG-18/22.....                               | 6            |
| Truck, Light .....                                 | 3            |

| <u>Equipment</u>                     | <u>Total</u> |
|--------------------------------------|--------------|
| Night Vision-Goggles .....           | 1            |
| Night Vision-Goggles (Driver).....   | 3            |
| Night Vision-Sight (Small Arms)..... | 6            |
| Radios:                              |              |
| VHF, Manpack, Low-Power.....         | 1            |
| VHF, Portable, Low-Power .....       | 4            |



**Automatic Grenade Launcher Platoon, Abn Inf Bn or  
Wpns Co, Commando Bn** \_\_\_\_\_

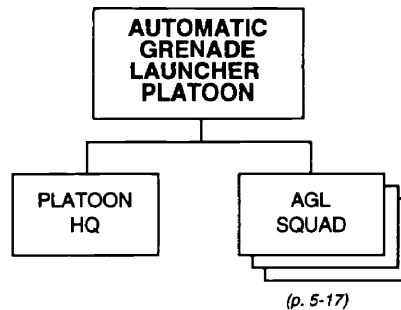

**PRINCIPAL ITEMS OF EQUIPMENT**

| <u>Equipment</u>                               | <u>Total</u> | <u>Equipment</u>                     | <u>Total</u> |
|--|--------------|--------------------------------------|--------------|
| 30-mm Automatic Grenade Launcher, AGS-17 ..... | 6            | Truck, Light .....                   | 3            |
| 9-mm Pistol, PM.....                           | 7            | Night-Vision Goggles (Driver) .....  | 3            |
| 5.45-mm Assault Rifle, AKS-74 .....            | 23           | Night-Vision Sight (Small Arms)..... | 3            |
| ATRL, RPG-18/22.....                           | 3            | Radio, VHF, Manpack, Low-Power ..... | 4            |

*NOTE:* Depending on the situation, the airborne infantry or commando battalion commander may retain the entire AGL platoon under his own control, or he may allocate its squads to individual companies.

**Automatic Grenade Launcher Squad, AGL Pit,  
Abn Inf Bn or Wpns Co, Commando Bn** \_\_\_\_\_



- Squad Leader .....AK-74
- Senior Rifleman ..... AKS-74, RPG-18/22
- Grenadier (x2)..... AGS-17, PM
- Rifleman/Asst Grenadier (x4) ..... AKS-74
- Truck Driver .....

**PRINCIPAL ITEMS OF EQUIPMENT**

| <u>Equipment</u>                               | <u>Total</u> | <u>Equipment</u>                     | <u>Total</u> |
|--|--------------|--------------------------------------|--------------|
| 30-mm Automatic Grenade Launcher, AGS-17 ..... | 2            | Truck, Light .....                   | 1            |
| 9-mm Pistol, PM.....                           | 2            | Night-Vision Goggles (Driver) .....  | 1            |
| 5.45-mm Assault Rifle, AKS-74 .....            | 7            | Night-Vision Sight (Small Arms)..... | 1            |
| ATRL, RPG-18/22.....                           | 1            | Radio, VHF, Manpack, Low-Power ..... | 1            |

Engineer Platoon,  
Abn Inf Bn

---

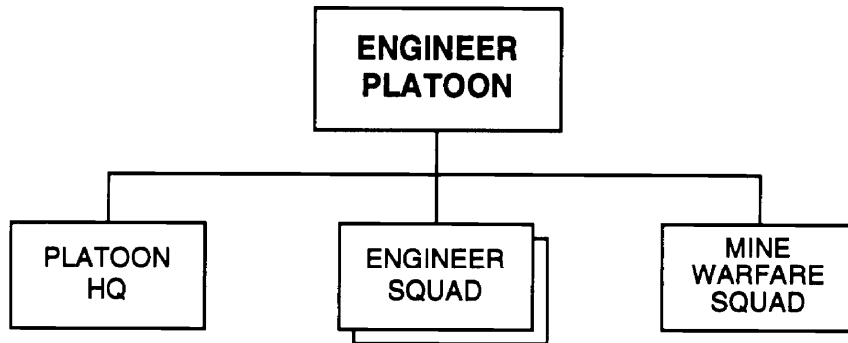

**PRINCIPAL ITEMS OF EQUIPMENT**

| <u>Equipment</u>                    | <u>Total</u> |
|-------------------------------------|--------------|
| 9-mm Pistol, PM.....                | 4            |
| 5.45-mm Assault Rifle, AKS-74 ..... | 25           |
| 5.45-mm LMG, RPKS-74.....           | 3            |
| ATGL, RPG-16D.....                  | 3            |
| Flamethrower, LPO/RPO.....          | 2            |
| Truck, Utility .....                | 1            |
| Truck, Light .....                  | 4            |
| Trailer, Cargo, 1-Axle.....         | 1            |

| <u>Equipment</u>                      | <u>Total</u> |
|---------------------------------------|--------------|
| Demolition Set.....                   | 3            |
| Mine Detector, DIM.....               | 1            |
| Night-Vision Goggles .....            | 1            |
| Night-Vision Goggles (Driver) .....   | 3            |
| Night-Vision Sight (Small Arms) ..... | 3            |
| Radios:                               |              |
| VHF, Manpack, Low-Power .....         | 3            |
| VHF, Portable, Low-Power .....        | 1            |

**Signal Platoon,  
Abn Inf Bn**

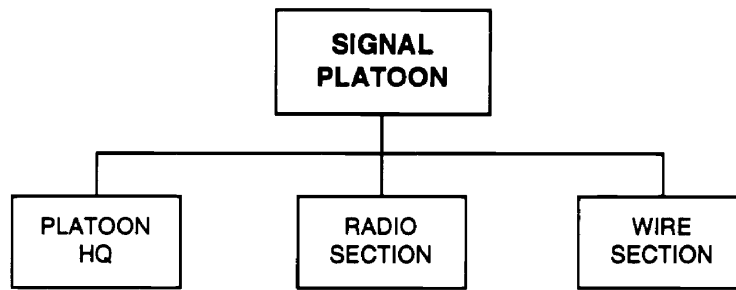

**PRINCIPAL ITEMS OF EQUIPMENT**

| <u>Equipment</u>                     | <u>Total</u> | <u>Equipment</u>             | <u>Total</u> |
|--------------------------------------|--------------|------------------------------|--------------|
| 9-mm Pistol, PM.....                 | 1            | Radios:                      |              |
| 5.45-mm Assault Rifle, AKS-74 .....  | 13           | VHF, Manpack, Low-Power..... | 3            |
| Truck, Utility .....                 | 1            | HF/VHF, Vehicle Mount,       |              |
| Truck, Light .....                   | 1            | Medium-Power .....           | 1            |
| Van, Signal.....                     | 1            | Ground-to-Air Set.....       | 1            |
| Night-Vision Goggles .....           | 1            | Burst Transmission .....     | 1            |
| Night-Vision Goggles (Driver).....   | 3            | Warning Receiver .....       | 1            |
| Night-Vision Sight (Small Arms)..... | 2            |                              |              |

**Materiel Support Platoon,  
Abn Inf Bn**

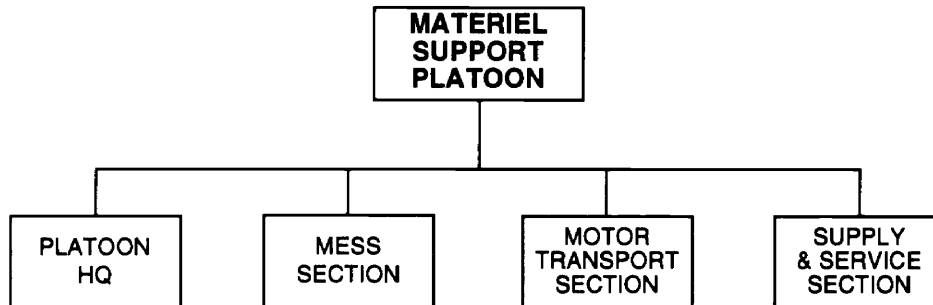

**PRINCIPAL ITEMS OF EQUIPMENT**

| <u>Equipment</u>                    | <u>Total</u> | <u>Equipment</u>                     | <u>Total</u> |
|-------------------------------------|--------------|--------------------------------------|--------------|
| 9-mm Pistol, PM.....                | 1            | Trailer, Generator.....              | 1            |
| 5.45-mm Assault Rifle, AKS-74 ..... | 20           | Trailer, Kitchen.....                | 3            |
| Truck, Light .....                  | 10           | Trailer, POL (1,200-Liter) .....     | 3            |
| Truck, POL (4,000-Liter).....       | 1            | Trailer, Water (900-Liter) .....     | 2            |
| Van, Maintenance .....              | 1            | Night-Vision Goggles (Driver).....   | 3            |
| Trailer, Cargo, 1-Axle.....         | 1            | Radio, VHF, Manpack, Low-Power ..... | 4            |

Medical Section,  
Abn Inf Bn

---

|                            |
|----------------------------|
| <b>MEDICAL<br/>SECTION</b> |
|----------------------------|

**PRINCIPAL ITEMS OF EQUIPMENT**

| <b><u>Equipment</u></b>             | <b><u>Total</u></b> | <b><u>Equipment</u></b>              | <b><u>Total</u></b> |
|-------------------------------------|---------------------|--------------------------------------|---------------------|
| Ambulance .....                     | 1                   | Night-Vision Goggles (Driver) .....  | 1                   |
| 5.45-mm Assault Rifle, AKS-74 ..... | 4                   | Radio, VHF, Manpack, Low-Power ..... | 1                   |

**Composite Artillery Battalion,  
Abn Inf Bde**

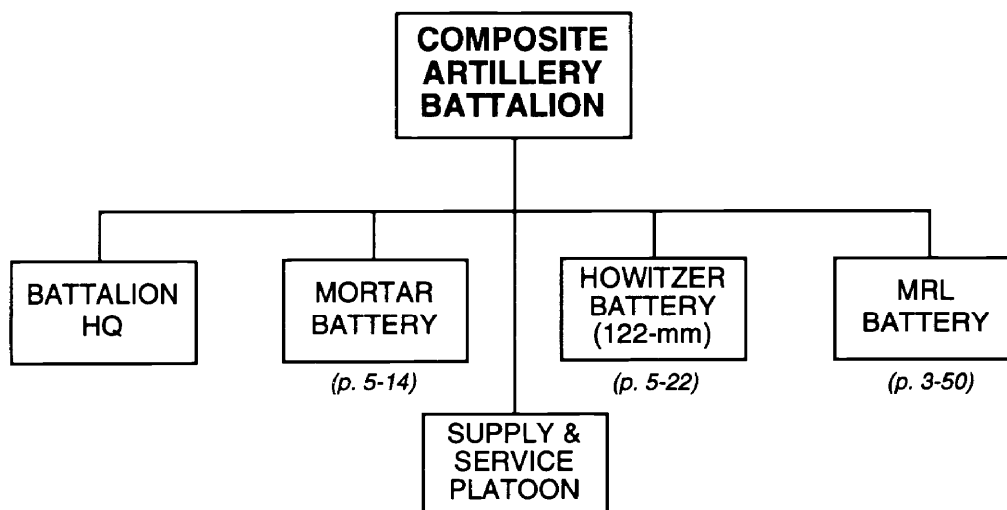

**PRINCIPAL ITEMS OF EQUIPMENT**

| <u>Equipment</u>   | <u>Total</u> | <u>Equipment</u>   | <u>Total</u> |
|--|--------------|--|--------------|
| 120-mm Mortar, M1943 or<br>82-mm Mortar, M1937/2B9 ..... | 6            | Trailer, Kitchen .....   | 3            |
| 122-mm Howitzer, D-30.....                               | 6            | Trailer, POL (1,200-Liter) .....   | 1            |
| 140-mm Multiple Rocket Launcher,<br>RPU-14 .....         | 6            | Trailer, Water (900-Liter) .....   | 1            |
| ACRV, 1V110 (Battery FDC) .....                          | 2            | Rangefinder, Stereoscopic, DS-1 .....  | 1            |
| SAM, Shoulder-Fired.....                                 | 6            | Rangefinder, Laser, SAGE GLOSS .....   | 1            |
| 7.62-mm GP MG, PKM.....                                  | 6            | Periscopic Aiming Circle, PAB2A .....  | 1            |
| ATGL, RPG-16D.....                                       | 5            | Collimator .....   | 6            |
| ATRL, RPG-18/22.....                                     | 2            | Radar, Battlefield Surveillance, Man-<br>Portable, PSNR-1 or TALL MIKE ..... | 1            |
| Truck, Utility .....                                     | 11           | Radios:  |              |
| Truck, Light .....                                       | 26           | VHF, Manpack, Low-Power .....  | 13           |
| Truck, POL (5,000-Liter).....                            | 1            | VHF, Portable, Low-Power .....   | 2            |
| Van, Maintenance .....                                   | 1            | VHF, Portable, Very-Low-Power .....  | 14           |
| Van, Signal.....   | 2            | VHF, Vehicle Mount,<br>Medium-Power .....                                    | 2            |
| Ambulance .....  | 1            | HF/VHF, Vehicle Mount,<br>Medium-Power .....                                 | 3            |
| Trailer, Cargo, 1-Axle.....                              | 7            | Warning Receiver .....   | 1            |
| Trailer, Generator.....                                  | 1            |  |              |

*NOTE:* The organization chart above shows the typical mix of battery types in a composite artillery battalion. However, some battalions may replace one of the battery types with an additional battery of another type.

122-mm Howitzer Battery, Composite Arty Bn,  
Abn Inf Bde

---

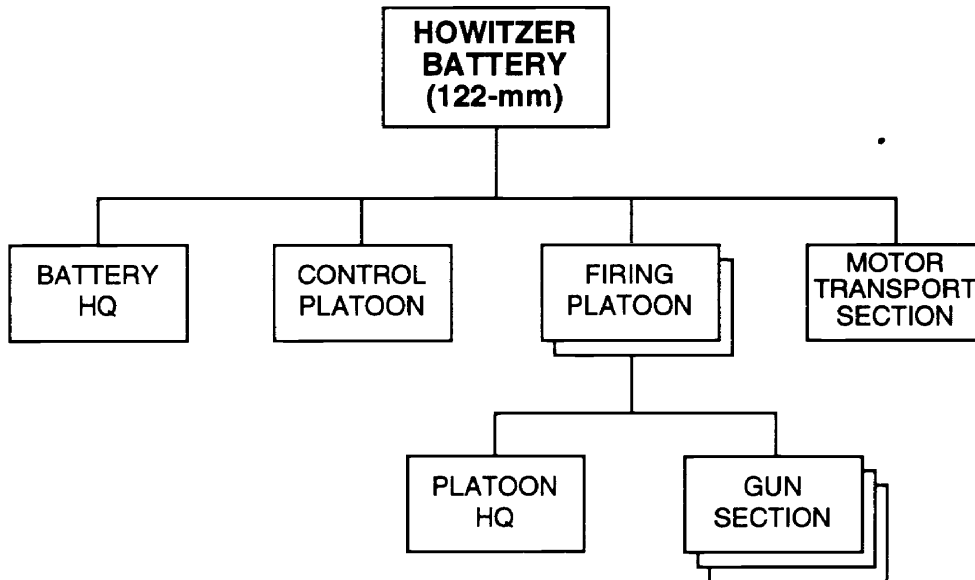

**PRINCIPAL ITEMS OF EQUIPMENT**

| <u>Equipment</u>                   | <u>Total</u> |
|------------------------------------|--------------|
| 122-mm Howitzer, D-30.....         | 6            |
| ACRV, 1V110 (Battery FDC) .....    | 1            |
| Truck, Utility (Battery COP) ..... | 1            |
| SAM, Shoulder-Fired.....           | 6            |
| 7.62-mm GP MG, PKM.....            | 6            |
| ATGL, RPG-16D.....                 | 2            |
| Truck, Light .....                 | 8            |
| Van, Signal.....                   | 1            |
| Trailer, Cargo, 1-Axle.....        | 1            |

| <u>Equipment</u>                    | <u>Total</u> |
|-------------------------------------|--------------|
| Rangefinder, Laser, SAGE GLOSS..... | 1            |
| Radios:                             |              |
| VHF, Manpack, Low-Power.....        | 2            |
| VHF, Portable, Very-Low-Power ..... | 7            |
| VHF, Vehicle Mount,                 |              |
| Medium-Power .....                  | 1            |
| HF/VHF, Vehicle Mount,              |              |
| Medium-Power .....                  | 1            |

**Antitank Platoon,  
Abn Inf Bde**

---

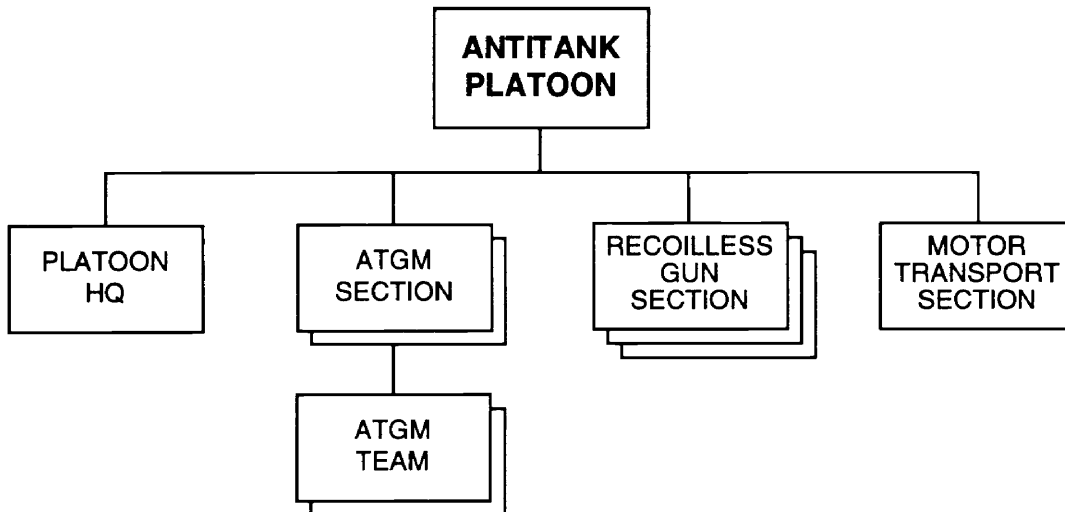

**PRINCIPAL ITEMS OF EQUIPMENT**

| <u>Equipment</u>                 | <u>Total</u> |
|----------------------------------|--------------|
| ATGM Manpack, AT-4/SPIGOT .....  | 6            |
| 73-mm Recoilless Gun, SPG-9..... | 3            |
| 9-mm Pistol, PM.....             | 11           |
| 5.45-mm LMG, AKSU-74.....        | 25           |
| Truck, Utility .....             | 1            |
| Truck, Light .....               | 5            |

| <u>Equipment</u>   | <u>Total</u> |
|--|--------------|
| Radar, Battlefield Surveillance, Man-<br>Portable, PSNR-1 or TALL MIKE ..... | 1            |
| Radios:  |              |
| VHF, Manpack, Low-Power.....   | 4            |
| VHF, Portable, Low-Power .....   | 7            |

Reconnaissance Company,  
Abn Inf Bde

---

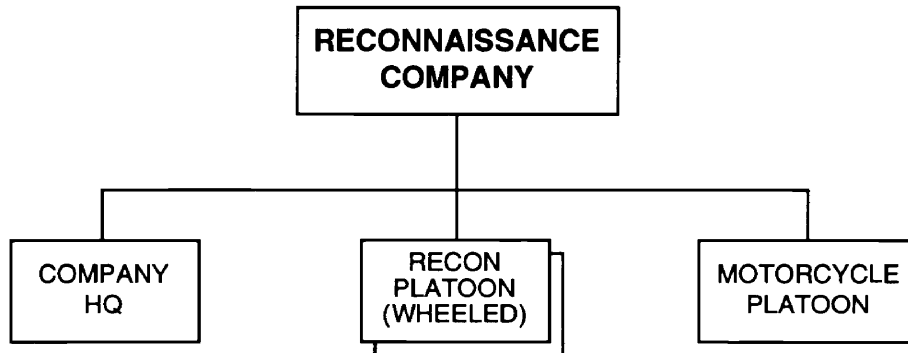

**PRINCIPAL ITEMS OF EQUIPMENT**

| <u>Equipment</u>                                    | <u>Total</u> |
|---|--------------|
| ACV, BRDM-2U .....                                  | 1            |
| ASC, BRDM-2 .....                                   | 8            |
| 9-mm Pistol, PM .....                               | 11           |
| 5.45-mm Assault Rifle, AKS-74 .....                 | 47           |
| ATGL, RPG-16D .....                                 | 9            |
| 40-mm Under-Barrel Grenade Launcher,<br>BG-15 ..... | 13           |
| Motorcycle .....                                    | 9            |
| Night-Vision Goggles .....                          | 13           |
| Night-Vision Sight (Small Arms) .....               | 9            |

| <u>Equipment</u>   | <u>Total</u> |
|--|--------------|
| Radar, Battlefield Surveillance, Man-<br>Portable, PSNR-1 or TALL MIKE ..... | 2            |
| Radios:  |              |
| VHF, Portable, Low-Power .....   | 13           |
| VHF, Vehicle Mount,<br>Medium-Power .....                                    | 9            |
| HF, Manpack, Low-Power .....   | 1            |
| HF, Vehicle Mount,<br>Medium-Power .....                                     | 1            |
| Burst Transmission .....   | 3            |
| Warning Receiver .....   | 1            |



**Engineer Company,  
Abn Inf Bde**

---

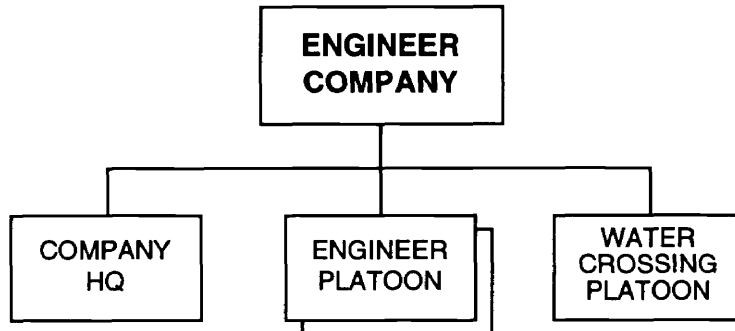

**PRINCIPAL ITEMS OF EQUIPMENT**

| <u>Equipment</u>                        | <u>Total</u> | <u>Equipment</u>                | <u>Total</u> |
|---|--------------|---------------------------------|--------------|
| ATGL, RPG-16D.....                      | 6            | Truck, Light .....              | 18           |
| Flamethrower, LPO/RPO.....              | 4            | Trailer, Kitchen.....           | 1            |
| Airportable Bridge, PVD-20/DPP-40 ..... | 10           | Trailer, Water (900-Liter)..... | 1            |
| Demolition Set .....                    | 6            | Radios:                         |              |
| Mine Detector, DIM.....                 | 2            | VHF, Manpack, Low-Power.....    | 6            |
| Truck, Utility .....                    | 1            | VHF, Portable, Low-Power .....  | 4            |

Signal Company,  
Abn Inf Bde

---

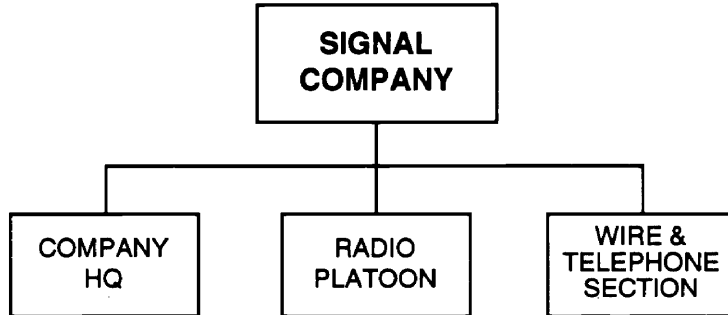

**PRINCIPAL ITEMS OF EQUIPMENT**

| <u>Equipment</u>        | <u>Total</u> |
|-------------------------|--------------|
| Truck, Utility .....    | 8            |
| Van, Signal.....        | 3            |
| Trailer, Generator..... | 1            |
| Trailer, Kitchen.....   | 1            |
| Motorcycle .....        | 3            |

| <u>Equipment</u>                             | <u>Total</u> |
|--|--------------|
| <b>Radios:</b>                               |              |
| HF/VHF, Manpack, Low-Power.....              | 6            |
| HF/VHF, Vehicle Mount,<br>Medium-Power ..... | 3            |
| HF/VHF, Vehicle Mount,<br>High-Power .....   | 1            |
| Ground-to-Air Set .....                      | 1            |
| Warning Receiver .....                       | 1            |

**NOTES:**

1. Motorcycles provide messenger/courier service.
2. Field telephones and switchboards are standard equipment in the wire and telephone section.

**Chemical Defense Platoon,  
Abn Inf Bde**

---

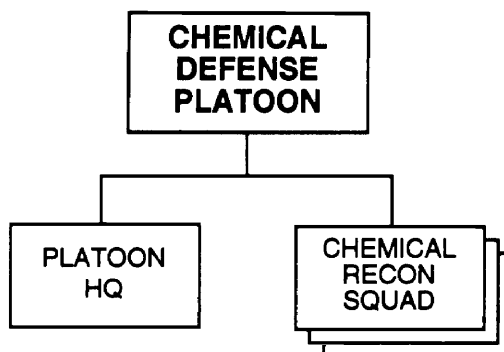

**PRINCIPAL ITEMS OF EQUIPMENT**

| <u>Equipment</u>                       | <u>Total</u> | <u>Equipment</u>            | <u>Total</u> |
|--|--------------|-----------------------------|--------------|
| Truck, Chemical Recon, UAZ-69RKh ..... | 4            | Radios:                     |              |
|  |              | VHF, Vehicle Mount,         |              |
|  |              | Medium-Power .....          | 4            |
|  |              | HF, Manpack, Low-Power..... | 1            |

**Material Support Company, Abn Inf Bde**

---

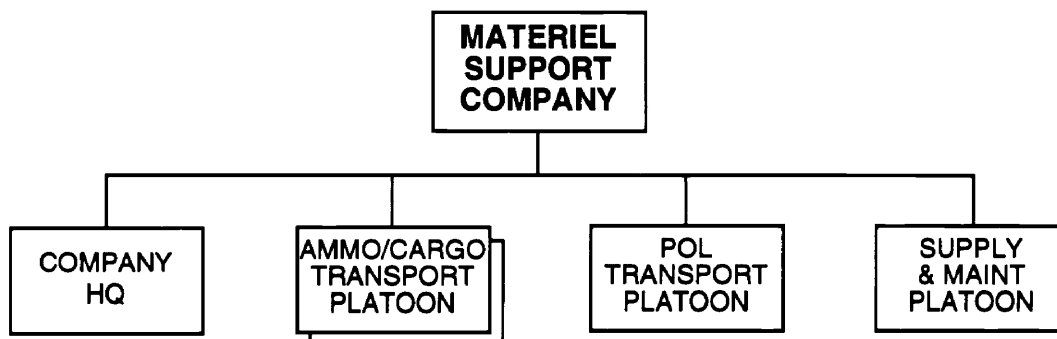

**PRINCIPAL ITEMS OF EQUIPMENT**

| <u>Equipment</u>              | <u>Total</u> | <u>Equipment</u>                     | <u>Total</u> |
|-------------------------------|--------------|--------------------------------------|--------------|
| ATGL, RPG-16D.....            | 3            | Trailer, Generator.....              | 1            |
| Truck, Utility .....          | 2            | Trailer, Kitchen .....               | 2            |
| Truck, Light .....            | 30           | Trailer, POL (1,200-Liter) .....     | 8            |
| Truck, POL (5,000-Liter)..... | 8            | Trailer, Water (900-Liter) .....     | 1            |
| Van, Maintenance .....        | 1            | Radio, VHF, Manpack, Low-Power ..... | 3            |
| Trailer, Cargo, 1-Axle.....   | 26           |                                      |              |

Maintenance Company,  
Abn Inf Bde

---

**MAINTENANCE  
COMPANY**

**PRINCIPAL ITEMS OF EQUIPMENT**

| <u>Equipment</u>            | <u>Total</u> | <u>Equipment</u>                     | <u>Total</u> |
|-----------------------------|--------------|--------------------------------------|--------------|
| ATGL, RPG-16D.....          | 4            | Trailer, Generator.....              | 2            |
| Truck, Utility .....        | 2            | Trailer, Kitchen.....                | 1            |
| Van, Maintenance .....      | 9            | Trailer, Water (900-Liter) .....     | 1            |
| Trailer, Cargo, 1-Axle..... | 4            | Radio, VHF, Manpack, Low-Power ..... | 1            |

Medical Platoon,  
Abn Inf Bde

---

**MEDICAL  
PLATOON**

**PRINCIPAL ITEMS OF EQUIPMENT**

| <u>Equipment</u>      | <u>Total</u> | <u>Equipment</u>                     | <u>Total</u> |
|-----------------------|--------------|--------------------------------------|--------------|
| Truck, Light .....    | 2            | Trailer, Water (900-Liter) .....     | 1            |
| Ambulance .....       | 4            | Radio, VHF, Manpack, Low-Power ..... | 2            |
| Trailer, Kitchen..... | 1            |                                      |              |

# Chapter 6

## National Asset Pool

The Ground Forces have a national asset pool with a variety of combat support and combat service support units. Chapters 1, 2, and 5 showed how units allocated from this pool can augment forces already organic to a division, military district, or military region. This chapter provides more detail on the various types of units that may be available for allocation from the national asset pool.

### CONTENTS

|  |      |
|--|------|
| <b>National Asset Pool, Ground Forces</b> .....                          | 6-3  |
| <b>Missile Troops and Artillery, National</b> .....                      | 6-4  |
| Artillery Brigade, Army or CDF or National .....                         | 6-5  |
| Artillery Brigade, Army or CDF or National (5 x 18-Tube Battalion) ..... | 6-6  |
| Artillery Brigade, Army or CDF or National (4 x 24-Tube Battalion) ..... | 6-8  |
| 152-mm Self-Propelled Gun Battalion, Arty Bde.....                       | 6-10 |
| Multiple Rocket Launcher Brigade, National .....                         | 6-11 |
| 220-mm Multiple Rocket Launcher Battalion, MRL Bde .....                 | 6-14 |
| Heavy Artillery Battalion, National .....                                | 6-15 |
| FROG Brigade, National .....   | 6-17 |
| FROG Battalion, FROG Bde or Separate .....                               | 6-19 |
| FROG Firing Battery, FROG Bn .....                                       | 6-20 |
| SSM Brigade (SS-21), National.....                                       | 6-21 |
| SSM Brigade (SCUD), National.....  | 6-23 |
| <b>Engineer Troops, National</b> .....                                   | 6-25 |
| Engineer Brigade, National or CDF.....                                   | 6-26 |
| Brigade Headquarters, Engr Bde .....                                     | 6-29 |
| Road and Bridge Battalion, Engr Bde.....                                 | 6-30 |
| Truck-Launched Bridge Company, Road and Bridge Bn .....                  | 6-32 |
| Tank-Launched Bridge Company, Road and Bridge Bn .....                   | 6-33 |
| Road Construction Company, Road and Bridge Bn .....                      | 6-34 |
| Obstacle Battalion, Engr Bde.....  | 6-35 |
| Obstacle Company, Obstacle Bn .....                                      | 6-37 |
| Obstacle Clearing Battalion, Engr Bde.....                               | 6-38 |
| Obstacle Clearing Company, Obstacle Clearing Bn .....                    | 6-40 |
| Water Crossing Regiment, National .....                                  | 6-41 |
| Pontoon Bridge Battalion, Water Crossing Regt or Engr Bde.....           | 6-43 |
| Assault Crossing Battalion, National or Water Crossing Regt.....         | 6-45 |

|   |      |
|---|------|
| <b>Signal Troops, National</b> .....              | 6-46 |
| Signal Regiment, National.....                    | 6-46 |
| Signal Brigade, National.....                     | 6-47 |
| <b>Chemical Troops, National</b> .....            | 6-47 |
| Chemical Defense Battalion, National.....         | 6-48 |
| Battalion Headquarters, Chem Def Bn.....          | 6-49 |
| Decontamination Company, Chem Def Bn.....         | 6-49 |
| Chemical Reconnaissance Company, Chem Def Bn..... | 6-50 |
| Supply and Service Platoon, Chem Def Bn.....      | 6-51 |
| Smoke Battalion, National.....                    | 6-52 |
| Smoke Company, Smoke Bn.....                      | 6-52 |
| <b>Logistics Troops, National</b> .....           | 6-53 |
| Materiel Support Brigade, MR or National.....     | 6-54 |
| Maintenance Brigade, MR or National.....          | 6-54 |

## National Asset Pool, Ground Forces

---

The national asset pool is actually a pool of Ground Forces assets. It contains no maneuver forces but rather a variety of *combat support* and *combat service support* assets. Centralization of these assets at the national level allows the General Staff/Ground Forces Headquarters to tailor support to subordinate military regions based on specific missions and the perceived threat. It can allocate or reallocate these assets as the situation requires.

Military regions are the primary recipients of these assets. The region may retain them under its own control. However, it can also allocate some or all of them to subordinate military districts to form district- or division-level support organizations. The General Staff/Ground Forces Headquarters also has the option of allocating to one region sufficient assets to form an expeditionary army. The number of assets allocated depends on the mission and the forces already garrisoned in the region.

The national asset pool has *no fixed structure*. The number and types of units can vary widely, depending on the situation. Therefore, the following organization chart merely outlines the types of units that may be able available for allocation.

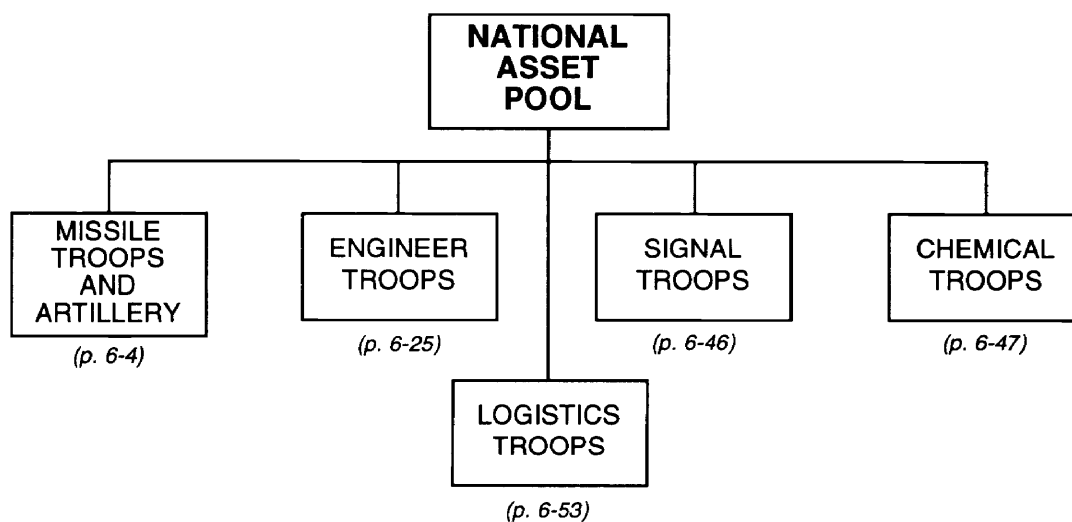

**NOTE:** A military region normally receives no more than one of any brigade- or regiment-sized unit type from the national asset pool. However, a region may receive more than one of some battalion-sized units.

Missile Troops and Artillery, National

The Chief of Missile Troops and Artillery in the General Staff/Ground Forces Headquarters controls several units. The numbers and types of units at this level can vary widely, depending on the size and structure of the Ground Forces they support. The following organization chart represents the **types** of artillery, rocket, and missile units that may be available.

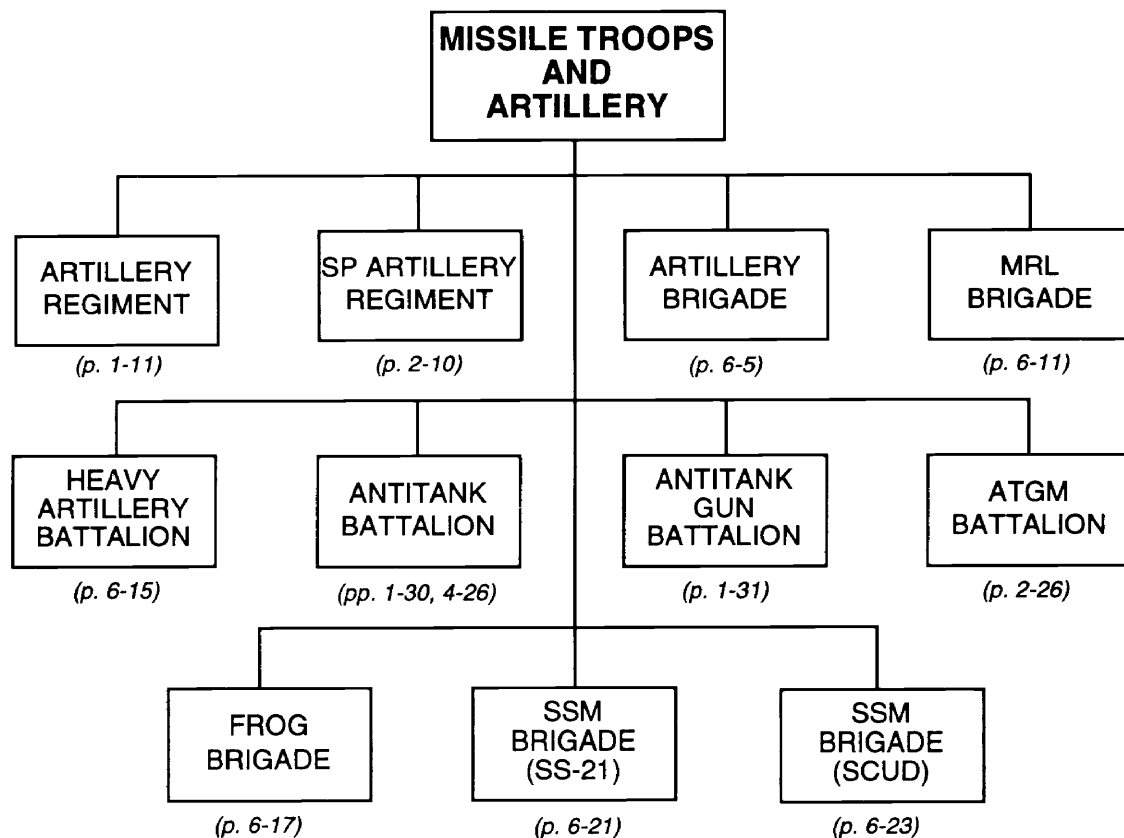

**NOTE:** The General Staff/Ground Forces Headquarters may allocate an entire regiment or brigade to support a military region or an army. However, it may also allocate these assets as individual battalions.

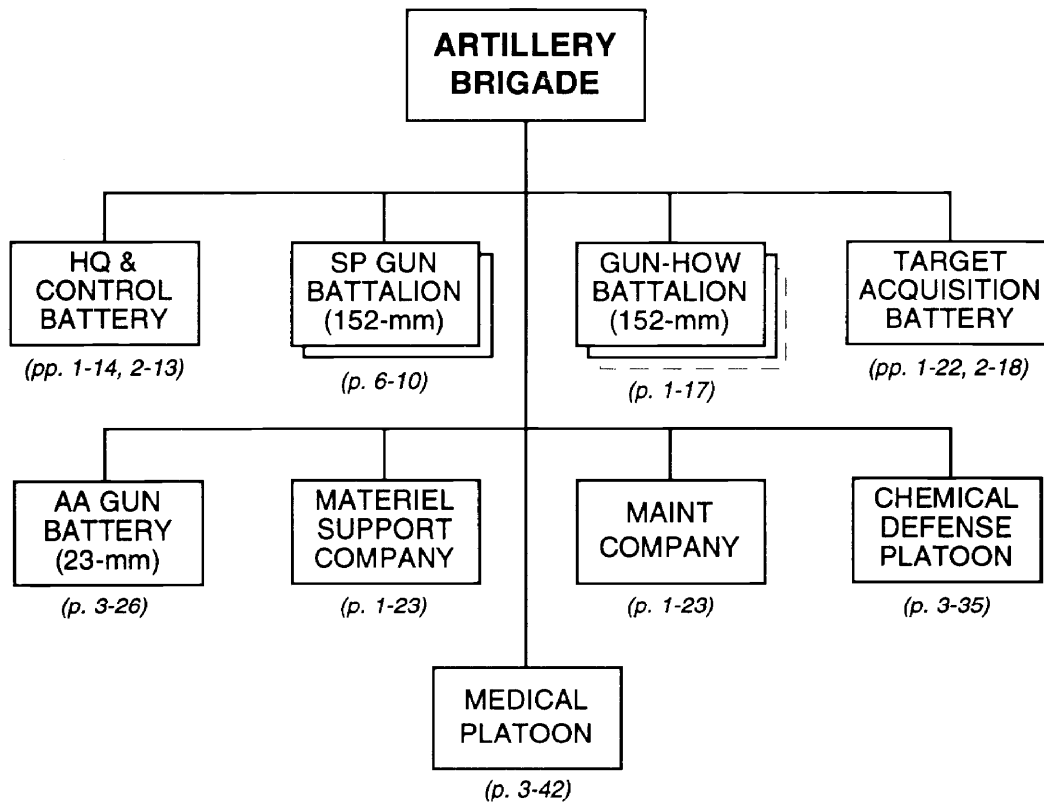

## Artillery Brigade, Army or CDF or National \_\_\_\_\_

**NOTES:**

1. An artillery brigade has either five 18-tube battalions (p. 6-6) or four 24-tube battalions (6-8).
2. The organization chart above shows the most common brigade structure. However, other combinations of gun and gun-howitzer battalions are possible. Some brigades may consist entirely of the 152-mm SP gun, 2S5 for both variants.
3. Instead of SP gun battalions, some brigades may have gun battalions equipped with the towed 152-mm field gun, 2A36. Some gun battalions may still have the older 130-mm field gun, M-46.
4. Structures of either four or five battalions may bear the designation artillery **regiment** (rather than brigade).
5. Equipment totals below for the headquarters and control battery and target acquisition battery reflect types and quantities associated primarily with towed systems (pp. 1-14 and 1-22). If the brigade has mostly SP gun battalions, these units are more likely to have the equipment types and quantities associated with SP systems (pp. 2-13 and 2-18).

**(continued)**

Artillery Brigade, Army or CDF or National  
(5 x 18-Tube Battalion)

| <i>Principal Items of Equipment</i> | <i>HQ &amp; Control Btry</i> | <i>SP Gun Bn (152-mm) (2X)</i> | <i>Gun-Howitzer Bn (152-mm) (3X)</i> | <i>AA Gun Btry (23-mm)</i> | <i>Target Acquisition Btry</i> | <i>Materiel Support Co</i> | <i>Maintenance Co</i> | <i>Chemical Defense Plt</i> | <i>Medical Plt</i> | <i>TOTAL</i> |
|-------------------------------------|------------------------------|--------------------------------|--------------------------------------|----------------------------|--------------------------------|----------------------------|-----------------------|-----------------------------|--------------------|--------------|
| <b>ARMORED VEHICLES</b>             |                              |                                |                                      |                            |                                |                            |                       |                             |                    |              |
| ACV, BTR (R-145BM)                  | 2                            |                                |                                      |                            | 1                              |                            |                       |                             |                    | 3            |
| Chemical Recon Vehicle, BRDM-2RKh   | 1                            |                                |                                      |                            |                                |                            |                       | 3                           |                    | 4            |
| APC, Radar, MT-LB (SNAR-10)*        |                              |                                |                                      |                            | 1                              |                            |                       |                             |                    | 1            |
| APC, Radar, MT-LB (ARK-1)**         |                              |                                |                                      |                            | 1                              |                            |                       |                             |                    | 1            |
| Mobile Recon Post, PRP-3/4***       |                              | 2                              |                                      |                            |                                |                            |                       |                             |                    | 2            |
| ACRV, 1V13/1V13M/1V22 (Btry FDC)    |                              | 6                              |                                      |                            |                                |                            |                       |                             |                    | 6            |
| ACRV, 1V14/1V14M/1V23 (Btry COP)    |                              | 6                              |                                      |                            |                                |                            |                       |                             |                    | 6            |
| ACRV, 1V15/1V15M/1V24 (Bn COP)      |                              | 2                              |                                      |                            |                                |                            |                       |                             |                    | 2            |
| ACRV, 1V16/1V16M/1V25 (Bn FDC)      |                              | 2                              |                                      |                            |                                |                            |                       |                             |                    | 2            |
| ACRV, 1V18 (Battery COP)            |                              |                                | 9                                    |                            |                                |                            |                       |                             |                    | 9            |
| ACRV, 1V19 (Battalion COP)          |                              |                                | 3                                    |                            |                                |                            |                       |                             |                    | 3            |
| <b>WEAPONS</b>                      |                              |                                |                                      |                            |                                |                            |                       |                             |                    |              |
| 152-mm SP Gun, 2S5                  |                              | 36                             |                                      |                            |                                |                            |                       |                             |                    | 36           |
| 152-mm Gun Howitzer, D-20           |                              |                                | 54                                   |                            |                                |                            |                       |                             |                    | 54           |
| 23-mm AA Gun, ZU-23                 |                              |                                |                                      | 8                          |                                |                            |                       |                             |                    | 8            |
| ATGL, RPG-7V                        | 4                            | 12                             | 18                                   |                            |                                |                            | 4                     |                             |                    | 38           |
| SAM, Shoulder-Fired                 | 3                            | 36                             | 54                                   |                            |                                |                            |                       |                             |                    | 93           |
| 7.62-mm GP MG, PKM                  |                              | 36                             | 54                                   |                            |                                |                            | 2                     |                             |                    | 92           |
| <b>TRUCKS</b>                       |                              |                                |                                      |                            |                                |                            |                       |                             |                    |              |
| ACRV, 1V110 (Battery FDC)           |                              |                                | 9                                    |                            |                                |                            |                       |                             |                    | 9            |
| ACRV, 1V111 (Battalion FDC)         |                              |                                | 3                                    |                            |                                |                            |                       |                             |                    | 3            |
| Truck, Utility                      | 7                            |                                | 3                                    | 1                          |                                | 1                          | 1                     |                             |                    | 13           |
| Truck, Light                        | 2                            |                                | 27                                   | 8                          | 3                              | 1                          |                       |                             | 1                  | 42           |
| Truck, Medium                       | 1                            | 40                             | 102                                  |                            | 3                              | 32                         | 3                     |                             | 2                  | 183          |
| Truck, Decon, ARS-12U/14            |                              |                                |                                      |                            |                                |                            |                       | 3                           |                    | 3            |
| Truck, Decon, DDA-53/66             |                              |                                |                                      |                            |                                |                            |                       | 1                           | 1                  | 2            |
| Truck, Crane                        |                              |                                |                                      |                            |                                |                            | 1                     |                             |                    | 1            |
| Truck, POL (5,000-L)                |                              | 8                              | 6                                    |                            |                                | 3                          |                       |                             |                    | 17           |
| Truck, Recovery                     |                              |                                |                                      |                            |                                |                            | 1                     |                             |                    | 1            |
| Truck, Water (2,000-L)              |                              |                                |                                      |                            |                                |                            |                       | 2                           |                    | 2            |
| Van, Hospital                       |                              |                                |                                      |                            |                                |                            |                       |                             | 1                  | 1            |
| Van, Maintenance                    |                              | 4                              | 3                                    |                            | 4                              | 2                          | 6                     |                             |                    | 19           |
| Van, Signal                         | 3                            | 8                              | 12                                   |                            |                                |                            |                       |                             |                    | 23           |
| Van, Survey                         |                              |                                |                                      |                            | 1                              |                            |                       |                             |                    | 1            |
| Ambulance                           |                              | 2                              | 3                                    |                            |                                |                            |                       |                             | 4                  | 9            |

**FOOTNOTES:**

- \* This system includes the BIG FRED battlefield surveillance radar.
- \*\* This system includes the RICE BAG countermortar/counterbattery radar.
- \*\*\* This system includes the SMALL FRED or TALL MIKE battlefield surveillance radar.

(continued)

Artillery Brigade, Army or CDF or National  
(5 x 18-Tube Battalion) (continued)

| <i>Principal Items of Equipment</i>                                | <i>HQ &amp; Control Btry</i> | <i>SP Gun Bn (152-mm) (2X)</i> | <i>Gun-Howitzer Bn (152-mm) (3x)</i> | <i>AA Gun Btry (23-mm)</i> | <i>Target Acquisition Btry</i> | <i>Material Support Co</i> | <i>Maintenance Co</i> | <i>Chemical Defense Plt</i> | <i>Medical Plt</i> | <i>TOTAL</i> |
|--|------------------------------|--------------------------------|--------------------------------------|----------------------------|--------------------------------|----------------------------|-----------------------|-----------------------------|--------------------|--------------|
| <b>TRAILERS</b>  |                              |                                |                                      |                            |                                |                            |                       |                             |                    |              |
| Trailer, Cargo, 1-Axle   |                              |                                |                                      |                            | 1                              |                            |                       |                             |                    | 1            |
| Trailer, Cargo, 2-Axle   |                              | 34                             | 33                                   |                            |                                | 20                         | 3                     |                             |                    | 90           |
| Trailer, Generator   | 2                            |                                | 3                                    |                            | 2                              |                            | 2                     |                             |                    | 9            |
| Trailer, Kitchen   | 1                            | 6                              | 9                                    |                            | 1                              |                            |                       |                             | 1                  | 18           |
| Trailer, POL (4,200-L)   |                              | 8                              | 6                                    |                            |                                | 3                          |                       |                             |                    | 17           |
| Trailer, Water (900-/1,200-L)                                      |                              | 2                              | 3                                    |                            | 1                              | 2                          |                       | 2                           | 1                  | 11           |
| Trailer, Welding   |                              |                                |                                      |                            |                                |                            | 1                     |                             |                    | 1            |
| <b>RADARS</b>  |                              |                                |                                      |                            |                                |                            |                       |                             |                    |              |
| Radar, Battlefield Surveillance, Man-Portable, PSNR-1 or TALL MIKE | 1                            |                                | 3                                    |                            | 1                              |                            |                       |                             |                    | 5            |
| <b>RADIOS</b>  |                              |                                |                                      |                            |                                |                            |                       |                             |                    |              |
| VHF, Manpack, Low-Power  | 6                            | 20                             | 42                                   | 3                          | 13                             | 1                          | 1                     |                             | 1                  | 87           |
| VHF, Portable, Low-Power   | 1                            |                                | 69                                   |                            |                                |                            |                       |                             |                    | 70           |
| VHF, Vehicle Mount, Medium-Power                                   | 4                            | 54                             | 24                                   |                            | 4                              |                            |                       | 3                           |                    | 89           |
| HF, Manpack, Low-Power   | 1                            |                                |                                      |                            |                                |                            |                       | 1                           |                    | 2            |
| HF, Vehicle Mount, Medium-Power                                    | 5                            |                                |                                      |                            |                                |                            |                       |                             |                    | 5            |
| HF/VHF, Vehicle Mount, Med-Power                                   | 3                            | 8                              | 12                                   |                            |                                |                            |                       |                             |                    | 23           |
| HF/VHF, Vehicle Mount, High-Power                                  | 1                            |                                |                                      |                            |                                |                            |                       |                             |                    | 1            |
| Radio Relay, VHF/UHF   | 1                            |                                |                                      |                            |                                |                            |                       |                             |                    | 1            |
| Warning Receiver   | 1                            | 4                              | 3                                    | 1                          | 1                              |                            |                       |                             |                    | 10           |
| <b>MISCELLANEOUS</b>   |                              |                                |                                      |                            |                                |                            |                       |                             |                    |              |
| Rangefinder, Laser, SAGE GLOSS                                     | 1                            | 8                              | 12                                   |                            | 2                              |                            |                       |                             |                    | 23           |
| Sound-Ranging Set  |                              |                                |                                      |                            | 1                              |                            |                       |                             |                    | 1            |

Artillery Brigade, Army or CDF or National  
(4 x 24-Tube Battalion)

| <i>Principal Items of Equipment</i> | <i>HQ &amp; Control Btry</i> | <i>SP Gun Bn (152-mm) (2X)</i> | <i>Gun-Howitzer Bn (152-mm) (2X)</i> | <i>AA Gun Btry (23-mm)</i> | <i>Target Acquisition Btry</i> | <i>Materiel Support Co</i> | <i>Maintenance Co</i> | <i>Chemical Defense Plt</i> | <i>Medical Plt</i> | <i>TOTAL</i> |
|-------------------------------------|------------------------------|--------------------------------|--------------------------------------|----------------------------|--------------------------------|----------------------------|-----------------------|-----------------------------|--------------------|--------------|
| <b>ARMORED VEHICLES</b>             |                              |                                |                                      |                            |                                |                            |                       |                             |                    |              |
| ACV, BTR (R-145BM)                  | 2                            |                                |                                      |                            | 1                              |                            |                       |                             |                    | 3            |
| Chemical Recon Vehicle, BRDM-2RKh   | 1                            |                                |                                      |                            |                                |                            |                       | 3                           |                    | 4            |
| APC, Radar, MT-LB (SNAR-10)*        |                              |                                |                                      |                            | 1                              |                            |                       |                             |                    | 1            |
| APC, Radar, MT-LB (ARK-1)**         |                              |                                |                                      |                            | 1                              |                            |                       |                             |                    | 1            |
| Mobile Recon Post, PRP-3/4***       |                              | 2                              |                                      |                            |                                |                            |                       |                             |                    | 2            |
| ACRV, 1V13/1V13M/1V22 (Btry FDC)    |                              | 6                              |                                      |                            |                                |                            |                       |                             |                    | 6            |
| ACRV, 1V14/1V14M/1V23 (Btry COP)    |                              | 6                              |                                      |                            |                                |                            |                       |                             |                    | 6            |
| ACRV, 1V15/1V15M/1V24 (Bn COP)      |                              | 2                              |                                      |                            |                                |                            |                       |                             |                    | 2            |
| ACRV, 1V16/1V16M/1V25 (Bn FDC)      |                              | 2                              |                                      |                            |                                |                            |                       |                             |                    | 2            |
| ACRV, 1V18 (Battery COP)            |                              |                                | 6                                    |                            |                                |                            |                       |                             |                    | 6            |
| ACRV, 1V19 (Battalion COP)          |                              |                                | 2                                    |                            |                                |                            |                       |                             |                    | 2            |
| <b>WEAPONS</b>                      |                              |                                |                                      |                            |                                |                            |                       |                             |                    |              |
| 152-mm SP Gun, 2S5                  |                              | 48                             |                                      |                            |                                |                            |                       |                             |                    | 48           |
| 152-mm Gun Howitzer, D-20           |                              |                                | 48                                   |                            |                                |                            |                       |                             |                    | 48           |
| 23-mm AA Gun, ZU-23                 |                              |                                |                                      | 8                          |                                |                            |                       |                             |                    | 8            |
| ATGL, RPG-7V                        | 4                            | 12                             | 12                                   |                            |                                |                            | 4                     |                             |                    | 32           |
| SAM, Shoulder-Fired                 | 3                            | 36                             | 36                                   |                            |                                |                            |                       |                             |                    | 75           |
| 7.62-mm GP MG, PKM                  |                              | 36                             | 36                                   |                            |                                |                            |                       |                             |                    | 72           |
| <b>TRUCKS</b>                       |                              |                                |                                      |                            |                                |                            |                       |                             |                    |              |
| ACRV, 1V110 (Battery FDC)           |                              |                                | 6                                    |                            |                                |                            |                       |                             |                    | 6            |
| ACRV, 1V111 (Battalion FDC)         |                              |                                | 2                                    |                            |                                |                            |                       |                             |                    | 2            |
| Truck, Utility                      | 7                            |                                | 3                                    | 1                          |                                | 1                          | 1                     |                             |                    | 13           |
| Truck, Light                        | 2                            |                                | 18                                   | 8                          | 3                              | 1                          |                       |                             | 1                  | 33           |
| Truck, Medium                       | 1                            | 40                             | 68                                   |                            | 3                              | 32                         | 3                     |                             | 2                  | 149          |
| Truck, Decon, ARS-12U/14            |                              |                                |                                      |                            |                                |                            |                       | 3                           |                    | 3            |
| Truck, Decon, DDA-53/66             |                              |                                |                                      |                            |                                |                            |                       | 1                           | 1                  | 2            |
| Truck, Crane                        |                              |                                |                                      |                            |                                |                            | 1                     |                             |                    | 1            |
| Truck, POL (5,000-L)                |                              | 8                              | 4                                    |                            |                                | 4                          |                       |                             |                    | 16           |
| Truck, Recovery                     |                              |                                |                                      |                            |                                |                            | 1                     |                             |                    | 1            |
| Truck, Water (2,000-L)              |                              |                                |                                      |                            |                                |                            |                       | 2                           |                    | 2            |
| Van, Hospital                       |                              |                                |                                      |                            |                                |                            |                       |                             | 1                  | 1            |
| Van, Maintenance                    |                              | 4                              | 3                                    |                            | 4                              | 2                          | 6                     |                             |                    | 19           |
| Van, Signal                         | 3                            | 8                              | 8                                    |                            |                                |                            |                       |                             |                    | 19           |
| Van, Survey                         |                              |                                |                                      |                            | 1                              |                            |                       |                             |                    | 1            |
| Ambulance                           |                              | 2                              | 3                                    |                            |                                |                            |                       |                             | 4                  | 9            |

(continued)

Artillery Brigade, Army or CDF or National  
(4 x 24-Tube Battalion) (continued)

| <i>Principal Items of Equipment</i>                                | <i>HQ &amp; Control Btry</i> | <i>SP Gun Bn (152-mm) (2X)</i> | <i>Gun-Howitzer Bn (152-mm) (2X)</i> | <i>AA Gun Btry (23-mm)</i> | <i>Target Acquisition Btry</i> | <i>Materiel Support Co</i> | <i>Maintenance Co</i> | <i>Chemical Defense Plt</i> | <i>Medical Plt</i> | <i>TOTAL</i> |
|--|------------------------------|--------------------------------|--------------------------------------|----------------------------|--------------------------------|----------------------------|-----------------------|-----------------------------|--------------------|--------------|
| <b>TRAILERS</b>  |                              |                                |                                      |                            |                                |                            |                       |                             |                    |              |
| Trailer, Cargo, 1-Axle   |                              |                                |                                      |                            | 1                              |                            |                       |                             |                    | 1            |
| Trailer, Cargo, 2-Axle   |                              | 34                             | 33                                   |                            |                                | 20                         | 3                     |                             |                    | 90           |
| Trailer, Generator   | 2                            |                                | 2                                    |                            | 2                              |                            | 2                     |                             |                    | 8            |
| Trailer, Kitchen   | 1                            | 6                              | 6                                    |                            | 1                              |                            |                       |                             | 1                  | 15           |
| Trailer, POL (4,200-L)   |                              | 8                              | 4                                    |                            |                                | 4                          |                       |                             |                    | 16           |
| Trailer, Water (900-/1,200-L)                                      |                              | 2                              | 2                                    |                            | 1                              | 2                          |                       | 2                           | 1                  | 10           |
| Trailer, Welding   |                              |                                |                                      |                            |                                |                            | 1                     |                             |                    | 1            |
| <b>RADARS</b>  |                              |                                |                                      |                            |                                |                            |                       |                             |                    |              |
| Radar, Battlefield Surveillance, Man-Portable, PSNR-1 or TALL MIKE | 1                            |                                | 2                                    |                            | 1                              |                            |                       |                             |                    | 4            |
| <b>RADIOS</b>  |                              |                                |                                      |                            |                                |                            |                       |                             |                    |              |
| VHF, Manpack, Low-Power  | 6                            | 20                             | 28                                   | 3                          | 13                             | 1                          | 1                     |                             | 1                  | 73           |
| VHF, Portable, Low-Power   | 1                            |                                | 23                                   |                            |                                |                            |                       |                             |                    | 24           |
| VHF, Vehicle Mount, Medium-Power                                   | 4                            | 54                             | 16                                   |                            | 4                              |                            |                       | 3                           |                    | 81           |
| HF, Manpack, Low-Power   | 1                            |                                |                                      |                            |                                |                            |                       | 1                           |                    | 2            |
| HF, Vehicle Mount, Medium-Power                                    | 5                            |                                |                                      |                            |                                |                            |                       |                             |                    | 5            |
| HF/VHF, Vehicle Mount, Med-Power                                   | 3                            | 4                              | 4                                    |                            |                                |                            |                       |                             |                    | 11           |
| HF/VHF, Vehicle Mount, High-Power                                  | 1                            |                                |                                      |                            |                                |                            |                       |                             |                    | 1            |
| Radio Relay, VHF/UHF   | 1                            |                                |                                      |                            |                                |                            |                       |                             |                    | 1            |
| Warning Receiver   | 1                            | 4                              | 3                                    | 1                          | 1                              |                            |                       |                             |                    | 10           |
| <b>MISCELLANEOUS</b>   |                              |                                |                                      |                            |                                |                            |                       |                             |                    |              |
| Rangefinder, Laser, SAGE GLOSS                                     | 1                            | 8                              | 8                                    |                            | 2                              |                            |                       |                             |                    | 19           |
| Sound-Ranging Set  |                              |                                |                                      |                            | 1                              |                            |                       |                             |                    | 1            |

152-mm Self-Propelled Gun Battalion,  
Arty Bde

---

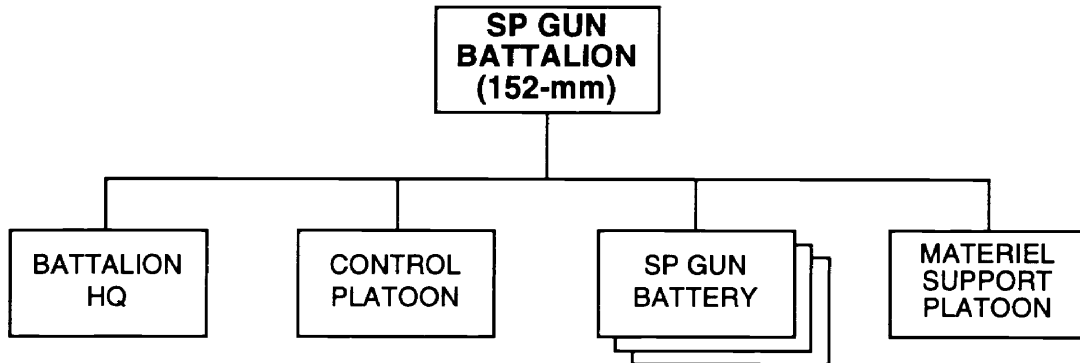

**PRINCIPAL ITEMS OF EQUIPMENT**

| <u>Equipment</u>                      | <u>Total</u> | <u>Equipment</u>                    | <u>Total</u> |
|---------------------------------------|--------------|-------------------------------------|--------------|
| 152-mm SP Gun, 2S5 .....              | 18           | Ambulance .....                     | 1            |
| ACRV, 1V13/1V13M/1V22 (Btry FDC) .... | 3            | Trailer, Cargo, 2-Axle.....         | 17           |
| ACRV, 1V14/1V14M/1V23 (Btry COP) .... | 3            | Trailer, Kitchen.....               | 3            |
| ACRV, 1V15/1V15M/1V24 (Bn COP).....   | 1            | Trailer, POL (4,200-Liter) .....    | 4            |
| ACRV, 1V16/1V16M/1V25 (Bn FDC).....   | 1            | Trailer, Water (1,200-Liter) .....  | 1            |
| Mobile Recon Post, PRP-3/4* .....     | 1            | Rangefinder, Laser, SAGE GLOSS..... | 4            |
| 7.62-mm GP MG, PKM.....               | 18           | Radios:                             |              |
| SAM, Shoulder-Fired.....              | 18           | VHF, Manpack, Low-Power.....        | 10           |
| ATGL, RPG-7V.....                     | 6            | VHF, Vehicle Mount,                 |              |
| Truck, Medium .....                   | 20           | Medium-Power .....                  | 27           |
| Truck, POL (5,000-Liter).....         | 4            | HF/VHF, Vehicle Mount,              |              |
| Van, Maintenance .....                | 2            | Medium-Power .....                  | 4            |
| Van, Signal.....                      | 4            | Warning Receiver .....              | 2            |

**FOOTNOTE:** \* This system includes the SMALL FRED or TALL MIKE battlefield surveillance radar.

## Multiple Rocket Launcher Brigade, National

---

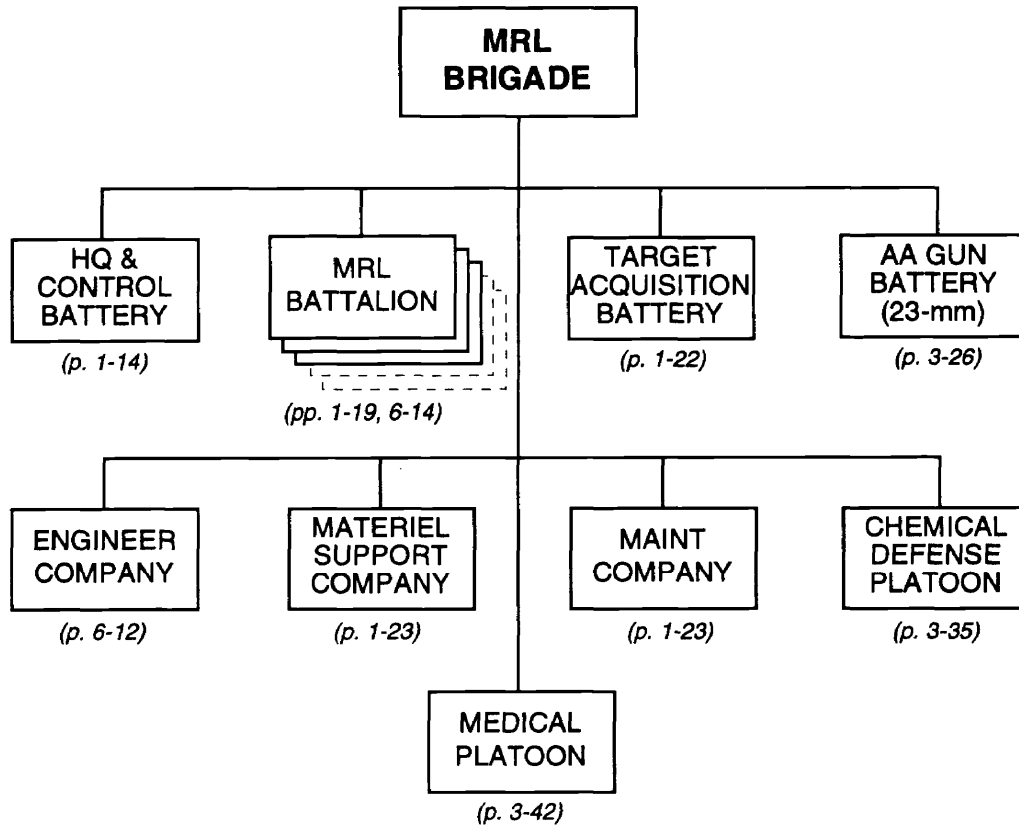

*NOTE:* It is possible for the brigade to have up to five battalions of 122-mm MRLs BM-21 or three battalions of 220-mm MRLs 9P140. However, the equipment listed below is only for three battalions of either MRL type.

**(continued)**

Multiple Rocket Launcher Brigade,  
National (continued)

| Principal Items of Equipment              | HQ & Control Btry | MRL Bn (3X) | Target Acquisition Btry | AA Gun Btry (23-mm) | Engineer Co | Materiel Support Co | Maintenance Co | Chemical Defense Plt | Medical Plt | TOTAL |
|---|-------------------|-------------|-------------------------|---------------------|-------------|---------------------|----------------|----------------------|-------------|-------|
| <b>ARMORED VEHICLES</b>                   |                   |             |                         |                     |             |                     |                |                      |             |       |
| ACV, BTR (R-145BM)                        | 2                 |             | 1                       |                     |             |                     |                |                      |             | 3     |
| Chemical Recon Vehicle, BRDM-2RKh         | 1                 |             |                         |                     |             |                     |                | 3                    |             | 4     |
| APC, Radar, MT-LB (SNAR-10)*              |                   |             | 1                       |                     |             |                     |                |                      |             | 1     |
| APC, Radar, MT-LB (ARK-1)**               |                   |             | 1                       |                     |             |                     |                |                      |             | 1     |
| ACRV, 1V18 (Battery COP)                  |                   | 9           |                         |                     |             |                     |                |                      |             | 9     |
| ACRV, 1V19 (Battalion COP)                |                   | 3           |                         |                     |             |                     |                |                      |             | 3     |
| <b>WEAPONS</b>                            |                   |             |                         |                     |             |                     |                |                      |             |       |
| 122-mm MRL, BM-21<br>or 220-mm MRL, 9P140 |                   | 54          |                         |                     |             |                     |                |                      |             | 54    |
| 23-mm AA Gun, ZU-23                       |                   |             |                         | 8                   |             |                     |                |                      |             | 8     |
| ATGL, RPG-7V                              | 4                 | 18          |                         |                     |             |                     | 4              | 4                    |             | 30    |
| SAM, Shoulder-Fired                       | 3                 | 54          |                         |                     |             |                     |                |                      |             | 57    |
| 5.45-mm LMG, RPK-74                       |                   |             |                         |                     |             |                     | 2              | 2                    |             | 4     |
| <b>ENGINEER EQUIPMENT</b>                 |                   |             |                         |                     |             |                     |                |                      |             |       |
| Route-Clearing Vehicle, BAT/PKT           |                   |             |                         |                     | 6           |                     |                |                      |             | 6     |
| Ditching Machine, PZM/MDK                 |                   |             |                         |                     | 4           |                     |                |                      |             | 4     |
| <b>TRUCKS</b>                             |                   |             |                         |                     |             |                     |                |                      |             |       |
| ACRV, 1V110 (Battery FDC)                 |                   | 9           |                         |                     |             |                     |                |                      |             | 9     |
| ACRV, 1V111 (Battalion FDC)               |                   | 3           |                         |                     |             |                     |                |                      |             | 3     |
| Truck, Utility                            | 7                 | 3           |                         | 1                   | 2           | 1                   | 1              |                      |             | 15    |
| Truck, Light                              | 2                 |             | 3                       | 8                   |             | 1                   |                |                      | 1           | 15    |
| Truck, Medium***                          | 1                 | 111         | 3                       |                     | 6           | 32                  | 3              |                      | 2           | 158   |
| Truck, Heavy                              |                   |             |                         |                     | 4           |                     |                |                      |             | 4     |
| Truck, Crane                              |                   |             |                         |                     | 2           |                     | 1              |                      |             | 3     |
| Truck, Crane Shovel                       |                   |             |                         |                     | 2           |                     |                |                      |             | 2     |
| Truck, Decon, ARS-12U/14                  |                   |             |                         |                     |             |                     |                | 3                    |             | 3     |
| Truck, Decon, DDA-53/66                   |                   |             |                         |                     |             |                     |                | 1                    | 1           | 2     |
| Truck, Dump                               |                   |             |                         |                     | 4           |                     |                |                      |             | 4     |
| Truck, POL (5,000-L)****                  |                   | 9           |                         |                     |             | 6                   |                |                      |             | 15    |
| Truck, Recovery                           |                   |             |                         |                     |             |                     | 1              |                      |             | 1     |
| Truck, Water (2,000-L)                    |                   |             |                         |                     |             |                     |                | 2                    |             | 2     |
| Van, Hospital                             |                   |             |                         |                     |             |                     |                |                      | 1           | 1     |
| Van, Maintenance                          |                   | 9           | 4                       |                     |             | 2                   | 6              |                      |             | 21    |
| Van, Signal                               | 3                 | 12          |                         |                     |             |                     |                |                      |             | 15    |
| Van, Survey                               |                   |             | 1                       |                     |             |                     |                |                      |             | 1     |
| Ambulance                                 |                   |             |                         |                     |             |                     |                |                      | 4           | 4     |

FOOTNOTES:

- \* This system includes the BIG FRED battlefield surveillance radar.
- \*\* This system includes the RICE BAG countermortar/counterbattery radar.
- \*\*\* Since 9P140 MRLs use special reload vehicles, the total number of medium trucks needed is 50.
- \*\*\*\* The POL requirements increase from 15 to 21 trucks and trailers for 9P140 MRL-equipped battalions.

(continued)



## Multiple Rocket Launcher Brigade, National (continued)

| <i>Principal Items of Equipment</i>                                | <i>HQ &amp; Control Btry</i> | <i>MRL Bn (3X)</i> | <i>Target Acquisition Btry</i> | <i>AA Gun Btry (23-mm)</i> | <i>Engineer Co</i> | <i>Materiel Support Co</i> | <i>Maintenance Co</i> | <i>Chemical Defense Plt</i> | <i>Medical Plt</i> | <i>TOTAL</i> |
|--|------------------------------|--------------------|--------------------------------|----------------------------|--------------------|----------------------------|-----------------------|-----------------------------|--------------------|--------------|
| <b>TRAILERS</b>  |                              |                    |                                |                            |                    |                            |                       |                             |                    |              |
| Trailer, Cargo, 1-Axle   | 1                            |                    | 1                              |                            | 3                  |                            |                       |                             |                    | 5            |
| Trailer, Cargo, 2-Axle   |                              | 81                 |                                |                            | 6                  | 20                         | 3                     |                             |                    | 110          |
| Trailer, Generator   | 2                            | 6                  | 2                              |                            |                    |                            | 2                     |                             |                    | 12           |
| Trailer, Kitchen   | 1                            | 3                  | 1                              |                            | 1                  |                            |                       |                             | 1                  | 7            |
| Trailer, POL (4,200-L)****   |                              | 9                  |                                |                            |                    | 6                          |                       |                             |                    | 15           |
| Trailer, Water (1,200-L)   |                              | 3                  | 1                              |                            | 1                  | 2                          |                       | 2                           | 1                  | 10           |
| Trailer, Welding   |                              |                    |                                |                            |                    |                            | 1                     |                             |                    | 1            |
| <b>RADARS</b>  |                              |                    |                                |                            |                    |                            |                       |                             |                    |              |
| Radar, Battlefield Surveillance, Man-Portable, PSNR-1 or TALL MIKE | 1                            |                    | 1                              |                            |                    |                            |                       |                             |                    | 2            |
| <b>RADIOS</b>  |                              |                    |                                |                            |                    |                            |                       |                             |                    |              |
| VHF, Manpack, Low-Power  | 6                            | 54                 | 13                             | 3                          | 6                  | 1                          | 1                     |                             | 1                  | 85           |
| VHF, Portable, Low-Power   | 1                            |                    |                                |                            |                    |                            |                       |                             |                    | 1            |
| VHF, Vehicle Mount, Medium-Power                                   | 4                            | 18                 | 4                              |                            | 4                  |                            |                       | 3                           |                    | 33           |
| HF, Manpack, Low-Power   | 1                            |                    |                                |                            |                    |                            |                       | 1                           |                    | 2            |
| HF, Vehicle Mount, Medium-Power                                    | 5                            |                    |                                |                            |                    |                            |                       |                             |                    | 5            |
| HF/VHF, Vehicle Mount, Med-Power                                   | 3                            | 18                 |                                |                            |                    |                            |                       |                             |                    | 21           |
| HF/VHF, Vehicle Mount, High-Power                                  | 1                            |                    |                                |                            |                    |                            |                       |                             |                    | 1            |
| Radio Relay, VHF/UHF   | 1                            |                    |                                |                            |                    |                            |                       |                             |                    | 1            |
| Warning Receiver   | 1                            | 3                  | 1                              | 1                          | 1                  |                            |                       |                             |                    | 7            |
| <b>MISCELLANEOUS</b>   |                              |                    |                                |                            |                    |                            |                       |                             |                    |              |
| Rangefinder, Laser, SAGE GLOSS                                     | 1                            |                    | 2                              |                            |                    |                            |                       |                             |                    | 3            |
| Sound-Ranging Set  |                              |                    | 1                              |                            |                    |                            |                       |                             |                    | 1            |
| Reload Vehicle for 9P140***  |                              | 108                |                                |                            |                    |                            |                       |                             |                    | 108          |

**FOOTNOTES:**

\*\*\* Since 9P140 MRLs use special reload vehicles, the total number of medium trucks needed is 50.

\*\*\*\* The POL requirements increase from 15 to 21 trucks and trailers for 9P140 MRL-equipped battalions.

**220-mm Multiple Rocket Launcher Battalion,  
MRL Bde**

---

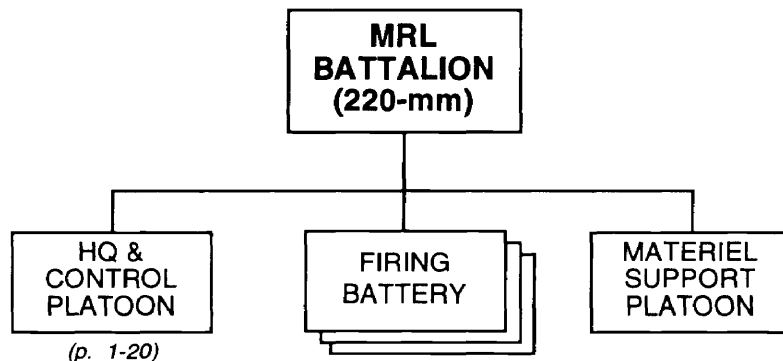

**PRINCIPAL ITEMS OF EQUIPMENT**

| <u>Equipment</u>                                 | <u>Total</u> | <u>Equipment</u>                   | <u>Total</u> |
|--|--------------|------------------------------------|--------------|
| 220-mm Rocket Launcher,<br>9P140 (Uragan)* ..... | 18           | Van, Signal.....                   | 4            |
| ACV, BTR (R-145BM) .....                         | 1            | Trailer, Cargo, 2-Axle.....        | 1            |
| ACRV, 1V18 (Battery COP) .....                   | 3            | Trailer, Generator.....            | 1            |
| ACRV, 1V19 (Battalion COP) .....                 | 1            | Trailer, Kitchen.....              | 1            |
| ACRV, 1V110 (Battery FDC) .....                  | 3            | Trailer, POL (4,200-Liter) .....   | 5            |
| ACRV, 1V111 (Battalion FDC) .....                | 1            | Trailer, Water (1,200-Liter) ..... | 1            |
| SAM, Shoulder-Fired.....                         | 18           | Radios:                            |              |
| ATGL, RPG-7V.....                                | 6            | VHF, Manpack, Low-Power.....       | 18           |
| Reload Vehicle for 9P140.....                    | 36           | VHF, Vehicle Mount,                |              |
| Truck, Utility .....                             | 3            | Medium-Power .....                 | 6            |
| Truck, Medium .....                              | 1            | HF/VHF, Vehicle Mount,             |              |
| Truck, POL (5,000-Liter).....                    | 5            | Medium-Power .....                 | 6            |
| Van, Maintenance .....                           | 3            | Warning Receiver .....             | 6            |

**FOOTNOTE:** \* Previously known as BM-22.

Heavy Artillery Battalion,  
National

---

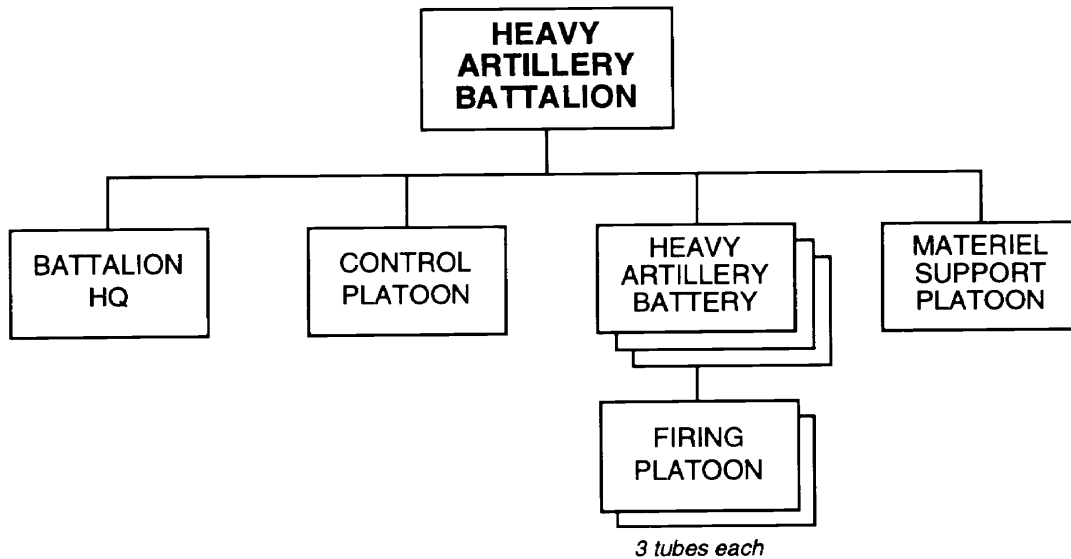

**NOTES:**

1. The heavy artillery battalion may be attached to an artillery brigade or regiment.
2. Some battalions can have 12 instead of 18 tubes when structured with two tubes per firing platoon.

**(continued)**

Heavy Artillery Battalion,  
National (continued)

| <i>Principal Items of Equipment</i> | <i>Bn HQ</i> | <i>Control Plt</i> | <i>Heavy Artillery Btry (3X)</i> | <i>Materiel Support Plt</i> | <i>TOTAL</i> |
|-------------------------------------|--------------|--------------------|----------------------------------|-----------------------------|--------------|
| <b>ARMORED VEHICLES</b>             |              |                    |                                  |                             |              |
| Mobile Recon Post, PRP-3/4 *        |              | 1                  |                                  |                             | 1            |
| ACRV, 1V18 (Battery COP)            |              |                    | 3                                |                             | 3            |
| ACRV, 1V19 (Battalion COP)          |              | 1                  |                                  |                             | 1            |
| <b>WEAPONS</b>                      |              |                    |                                  |                             |              |
| 180-mm Gun-Howitzer, S23            |              |                    | 18                               |                             | 18           |
| SAM, Shoulder-Fired                 | 1            | 2                  | 18                               |                             | 21           |
| ATGL, RPG-7V                        |              |                    | 18                               |                             | 18           |
| <b>TRUCKS</b>                       |              |                    |                                  |                             |              |
| Truck, Utility                      | 1            |                    |                                  |                             | 1            |
| Truck, Light                        | 1            | 1                  | 6                                | 2                           | 10           |
| Truck, Medium                       |              |                    |                                  | 26                          | 26           |
| Truck, Heavy                        |              |                    | 18                               |                             | 18           |
| ACRV, 1V110 (Battery FDC)           |              |                    | 3                                |                             | 3            |
| ACRV, 1V111 (Battalion FDC)         |              | 1                  |                                  |                             | 1            |
| Truck, POL (5,000-L)                |              |                    |                                  | 3                           | 3            |
| Truck, Water (2,000-L)              |              |                    |                                  | 1                           | 1            |
| Van, Command                        | 1            |                    |                                  |                             | 1            |
| Van, Maintenance                    |              |                    |                                  | 2                           | 2            |
| Van, Signal                         |              | 1                  | 3                                |                             | 4            |
| Ambulance                           |              |                    |                                  | 1                           | 1            |
| <b>TRAILERS</b>                     |              |                    |                                  |                             |              |
| Trailer, Cargo, 2-Axle              |              |                    |                                  | 18                          | 18           |
| Trailer, Generator                  |              |                    |                                  | 2                           | 2            |
| Trailer, Kitchen                    |              |                    |                                  | 3                           | 3            |
| Trailer, Water (900-/1,200-Liter)   |              |                    |                                  | 1                           | 1            |
| Trailer, POL (4,200-Liter)          |              |                    |                                  | 3                           | 3            |
| <b>RADIOS</b>                       |              |                    |                                  |                             |              |
| VHF, Manpack, Low-Power             | 1            | 1                  |                                  | 8                           | 10           |
| VHF, Vehicle Mount, Medium-Power    | 1            | 1                  | 3                                | 10                          | 15           |

FOOTNOTE: \* This system includes the SMALL FRED or TALL MIKE battlefield surveillance radar.

**FROG Brigade,  
National**

---

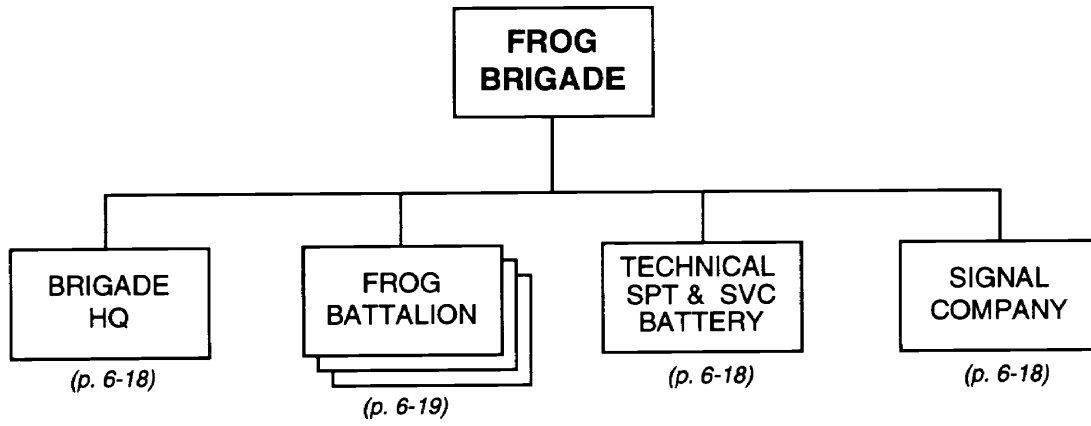

*NOTE:* This unit may bear the designation of **regiment** instead of brigade.

**(continued)**

FROG Brigade,  
National (continued)

| <i>Principal Items of Equipment</i> | <i>Brigade HQ</i> | <i>FROG Bn (3X)</i> | <i>Technical Spt &amp; Svc Btry</i> | <i>Signal Co</i> | <i>TOTAL</i> |
|-------------------------------------|-------------------|---------------------|-------------------------------------|------------------|--------------|
| <b>ARMORED VEHICLES</b>             |                   |                     |                                     |                  |              |
| ACV, BTR (R-145BM)                  | 1                 | 12                  |                                     |                  | 13           |
| <b>WEAPONS</b>                      |                   |                     |                                     |                  |              |
| FROG-7 TEL                          |                   | 12                  |                                     |                  | 12           |
| SAM, Shoulder-Fired                 | 3                 | 12                  | 3                                   |                  | 18           |
| <b>TRUCKS</b>                       |                   |                     |                                     |                  |              |
| Truck, Utility                      | 3                 | 12                  |                                     | 5                | 20           |
| Truck, Light                        | 1                 | 18                  | 6                                   | 3                | 28           |
| Truck, Medium                       |                   | 24                  | 5                                   | 1                | 30           |
| Truck, Heavy (Rocket Transporter)   |                   | 12                  |                                     |                  | 12           |
| Truck, Crane                        |                   | 3                   | 3                                   |                  | 6            |
| Truck, POL (5,000-L)                |                   | 6                   |                                     |                  | 6            |
| Truck, Water (2,000-L)              |                   | 3                   |                                     |                  | 3            |
| Van, Command                        | 1                 |                     |                                     |                  | 1            |
| Van, Maintenance                    |                   | 3                   | 2                                   |                  | 5            |
| Van, Signal                         |                   | 9                   |                                     | 10               | 19           |
| Van, Survey                         |                   | 12                  |                                     |                  | 12           |
| Ambulance                           |                   | 3                   |                                     |                  | 3            |
| <b>TRAILERS</b>                     |                   |                     |                                     |                  |              |
| Trailer, Cargo                      |                   | 6                   |                                     | 1                | 7            |
| Trailer, Generator                  |                   | 12                  | 1                                   | 1                | 14           |
| Trailer, Kitchen                    |                   | 3                   | 1                                   | 1                | 5            |
| Trailer, POL (4,200-L)              |                   | 6                   |                                     |                  | 6            |
| Trailer, Water (900-/1,200-L)       |                   | 3                   | 1                                   | 1                | 5            |
| <b>RADARS</b>                       |                   |                     |                                     |                  |              |
| Radar, Meteorological, END TRAY     |                   | 6                   |                                     |                  | 6            |
| <b>RADIOS</b>                       |                   |                     |                                     |                  |              |
| VHF, Manpack, Low-Power             |                   | 51                  | 1                                   | 7                | 59           |
| VHF, Portable, Very-Low-Power       | 1                 | 3                   | 3                                   |                  | 7            |
| VHF, Vehicle Mount, Medium-Power    | 1                 | 12                  |                                     | 1                | 14           |
| HF, Manpack, Low-Power              |                   | 6                   |                                     | 2                | 8            |
| HF/VHF, Vehicle Mount, Medium-Power |                   | 21                  |                                     | 10               | 31           |
| HF/VHF, Vehicle Mount, High-Power   |                   | 3                   |                                     | 3                | 6            |
| Radio Relay, VHF/UHF                |                   | 3                   |                                     | 2                | 5            |
| Warning Receiver                    | 1                 | 3                   |                                     | 1                | 5            |
| <b>MISCELLANEOUS</b>                |                   |                     |                                     |                  |              |
| Motorcycle                          |                   |                     |                                     | 3                |              |
| Rangefinder, Stereoscopic           |                   | 12                  |                                     |                  | 12           |

**FROG Battalion,  
FROG Bde or Separate** \_\_\_\_\_

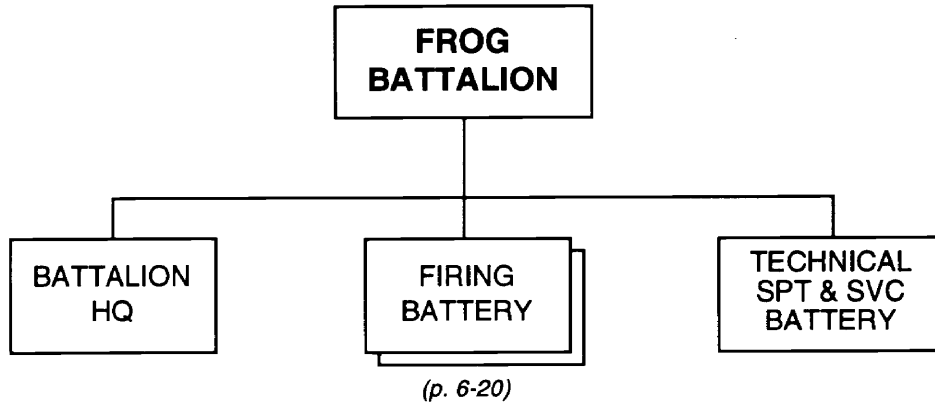

**PRINCIPAL ITEMS OF EQUIPMENT**

| <u>Equipment</u>                        | <u>Total</u> | <u>Equipment</u>                      | <u>Total</u> |
|---|--------------|---------------------------------------|--------------|
| ACV, BTR (R-145BM) .....                | 4            | Trailer, POL (4,200-Liter) .....      | 2            |
| FROG TEL .....                          | 4            | Trailer, Water (1,200-Liter) .....    | 1            |
| SAM, Shoulder-Fired.....                | 4            | Rangefinder, Stereoscopic .....       | 4            |
| Truck, Utility .....                    | 4            | Radar, Meteorological, END TRAY ..... | 2            |
| Truck, Light .....                      | 6            | Radios:                               |              |
| Truck, Medium .....                     | 8            | VHF, Manpack, Low-Power.....          | 17           |
| Truck, Heavy (Rocket Transporter) ..... | 4            | VHF, Portable, Very-Low-Power .....   | 1            |
| Truck, Crane .....                      | 1            | VHF, Vehicle Mount,                   |              |
| Truck, POL (5,000-Liter).....           | 2            | Medium-Power .....                    | 4            |
| Truck, Water (2,000-Liter.....          | 1            | HF, Manpack, Low-Power.....           | 2            |
| Van, Maintenance .....                  | 1            | HF/VHF, Vehicle Mount,                |              |
| Van, Signal.....                        | 3            | Medium-Power .....                    | 7            |
| Van, Survey.....                        | 4            | HF/VHF, Vehicle Mount,                |              |
| Ambulance .....                         | 1            | High-Power.....                       | 1            |
| Trailer, Cargo.....                     | 2            | Radio Relay, VHF/UHF.....             | 1            |
| Trailer, Generator.....                 | 4            | Warning Receiver .....                | 1            |
| Trailer, Kitchen.....                   | 1            |                                       |              |

**FROG Firing Battery,  
FROG Bn**

---

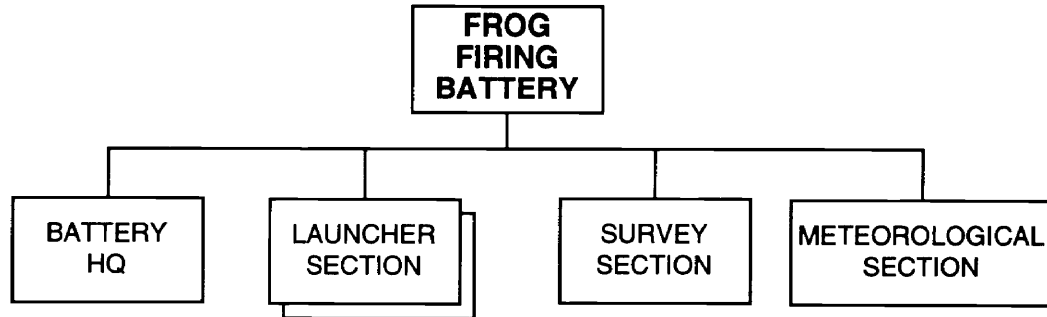

**PRINCIPAL ITEMS OF EQUIPMENT**

| <u>Equipment</u>         | <u>Total</u> |
|--------------------------|--------------|
| ACV, BTR (R-145BM) ..... | 1            |
| FROG TEL .....           | 2            |
| Truck, Utility .....     | 1            |
| Truck, Light .....       | 3            |
| Truck, Medium .....      | 4            |
| Van, Signal.....         | 1            |
| Van, Survey.....         | 2            |

| <u>Equipment</u>                             | <u>Total</u> |
|--|--------------|
| Trailer, Generator.....                      | 1            |
| Radar, Meteorological, END TRAY .....        | 1            |
| Radios:                                      |              |
| VHF, Manpack, Low-Power.....                 | 6            |
| HF/VHF, Vehicle Mount,<br>Medium-Power ..... | 1            |



**SSM Brigade (SS-21),  
National**

---

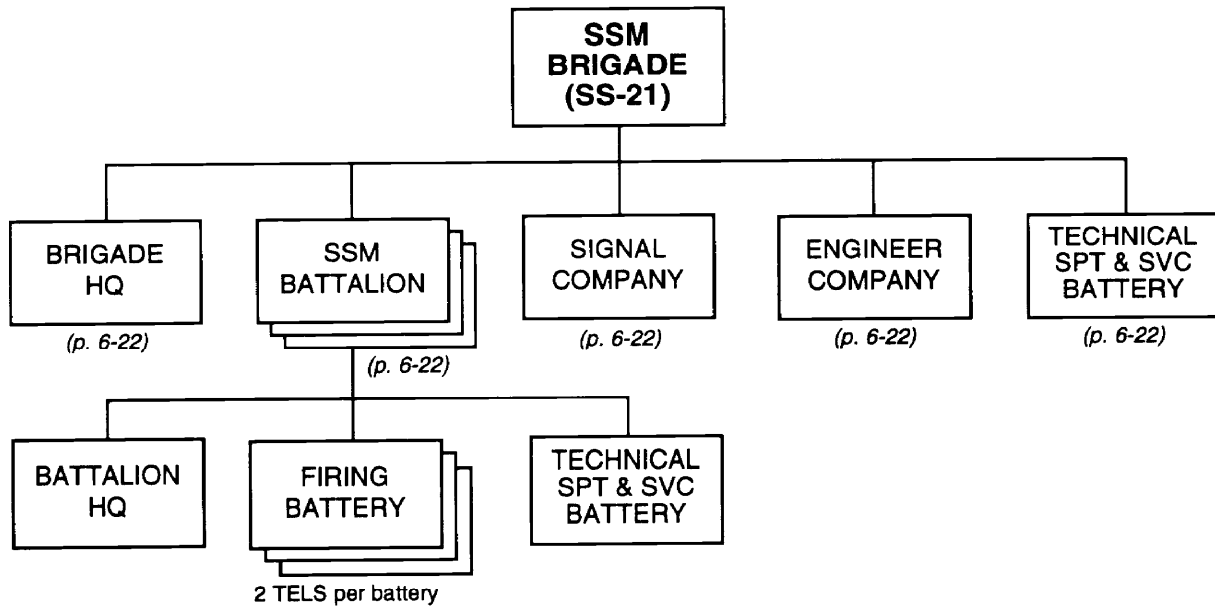

*NOTE: SS-21/SCARABs may also deploy as individual battalions. The General Staff/Ground Forces Headquarters always controls both SSM brigades and separate battalions.*

**(continued)**

SSM Brigade (SS-21 ),  
National (continued)

| <i>Principal Items of Equipment</i> | <i>Brigade HQ</i> | <i>SSM Bn (3X)</i> | <i>Signal Co</i> | <i>Engineer Co</i> | <i>Technical Spt &amp; Svc Btry</i> | <i>TOTAL</i> |
|-------------------------------------|-------------------|--------------------|------------------|--------------------|-------------------------------------|--------------|
| <b>ARMORED VEHICLES</b>             |                   |                    |                  |                    |                                     |              |
| ACV, BTR (R-145BM)                  | 1                 | 18                 |                  |                    |                                     | 19           |
| <b>WEAPONS</b>                      |                   |                    |                  |                    |                                     |              |
| SSM, SS-21/SCARAB TEL               |                   | 18                 |                  |                    |                                     | 18           |
| SAM, Shoulder-Fired                 | 3                 | 18                 |                  |                    | 3                                   | 24           |
| <b>ENGINEER EQUIPMENT</b>           |                   |                    |                  |                    |                                     |              |
| Route-Clearing Vehicle, BAT/PKT     |                   |                    |                  | 6                  |                                     | 6            |
| Ditching Machine, PZM/MDK           |                   |                    |                  | 4                  |                                     | 4            |
| <b>TRUCKS</b>                       |                   |                    |                  |                    |                                     |              |
| Truck, Utility                      | 3                 | 3                  | 5                | 2                  |                                     | 13           |
| Truck, Light                        | 1                 |                    | 3                |                    |                                     | 4            |
| Truck, Medium                       | 1                 | 18                 | 1                | 6                  | 30                                  | 56           |
| Truck, Heavy                        |                   |                    |                  | 4                  |                                     | 4            |
| Truck, Decon, ARS-12U/14            |                   | 3                  |                  |                    | 1                                   | 4            |
| Truck, Crane Shovel                 |                   |                    |                  | 2                  |                                     | 2            |
| Truck, Crane                        |                   | 3                  |                  |                    | 3                                   | 6            |
| Truck, POL (5,000-L)                |                   | 6                  |                  | 3                  | 1                                   | 10           |
| Truck, Water (2,000-L)              |                   | 3                  |                  |                    | 2                                   | 5            |
| Van, Command                        | 1                 |                    |                  |                    |                                     | 1            |
| Van, Signal                         |                   | 9                  | 10               |                    |                                     | 19           |
| Van, Survey                         |                   | 3                  |                  |                    |                                     | 3            |
| Ambulance                           |                   | 3                  |                  | 1                  | 1                                   | 5            |
| <b>TRAILERS</b>                     |                   |                    |                  |                    |                                     |              |
| Trailer, Cargo, 1-Axle              | 1                 | 3                  | 1                |                    | 1                                   | 6            |
| Trailer, Cargo, 2-Axle              |                   | 6                  |                  | 2                  | 2                                   | 10           |
| Trailer, Generator                  |                   | 3                  |                  | 1                  | 1                                   | 5            |
| Trailer, Kitchen                    |                   | 3                  | 1                | 1                  | 1                                   | 6            |
| Trailer, POL (4,200-L)              |                   | 6                  |                  | 3                  | 1                                   | 10           |
| Trailer, Water (1,200-L)            |                   | 3                  | 1                | 1                  | 2                                   | 7            |
| Trailer, Welding                    |                   |                    |                  | 1                  |                                     | 1            |
| <b>RADIOS</b>                       |                   |                    |                  |                    |                                     |              |
| VHF, Manpack, Low-Power             | 1                 | 34                 | 7                | 6                  | 18                                  | 66           |
| VHF, Portable, Low-Power            | 1                 | 3                  |                  |                    | 1                                   | 5            |
| VHF, Vehicle Mount, Medium-Power    | 1                 | 36                 | 1                | 3                  |                                     | 41           |
| HF, Manpack, Low-Power              | 1                 | 9                  | 2                | 1                  |                                     | 13           |
| HF, Vehicle Mount, Medium-Power     |                   |                    | 2                |                    |                                     | 2            |
| HF, Vehicle Mount, High-Power       | 1                 |                    | 1                |                    |                                     | 2            |
| HF/VHF, Vehicle Mount, Med-Power    | 1                 | 9                  | 8                |                    |                                     | 18           |
| HF/VHF, Vehicle Mount, High-Power   | 1                 |                    | 2                |                    |                                     | 3            |
| Radio Relay, VHF/UHF                |                   | 3                  | 2                |                    |                                     | 5            |
| Warning Receiver                    | 1                 | 3                  | 1                |                    | 1                                   | 6            |
| <b>MISCELLANEOUS</b>                |                   |                    |                  |                    |                                     |              |
| Missile Resupply Vehicle            |                   | 18                 |                  |                    |                                     | 18           |
| Motorcycle                          |                   |                    | 3                |                    |                                     | 3            |

**SSM Brigade (SCUD),  
National**

---

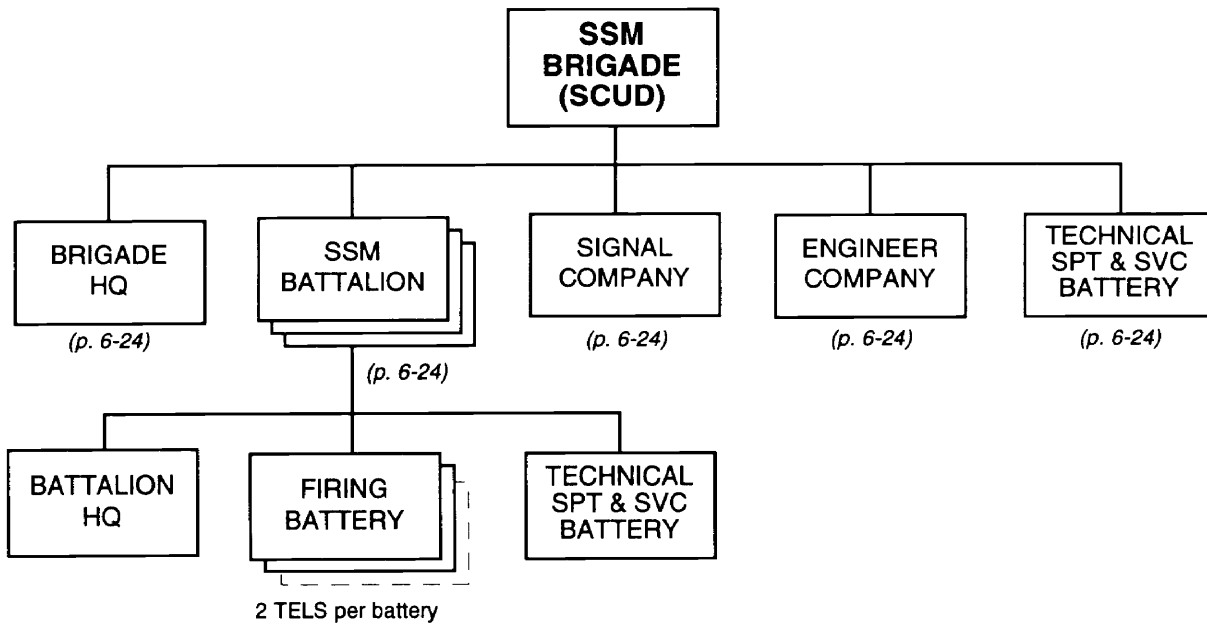

**NOTES:**

1. An SSM battalion may consist of either two or three firing batteries. Therefore, a battalion may have 4 or 6 TELs, and a brigade may have 12 or 18 TELs. There is at least one reload per TEL.
2. The General Staff/Ground Forces Headquarters may deploy individual SSM battalions rather than entire brigades. If fielded in this manner, the battalion always has three batteries.

**(continued)**

SSM Brigade (SCUD),  
National (continued)

| <i>Principal Items of Equipment</i> | <i>Brigade HQ</i> | <i>SSM Bn (3X)</i> | <i>Signal Co</i> | <i>Engineer Co</i> | <i>Technical Spt &amp; Svc Btry</i> | <i>TOTAL</i> |
|-------------------------------------|-------------------|--------------------|------------------|--------------------|-------------------------------------|--------------|
| <b>ARMORED VEHICLES</b>             |                   |                    |                  |                    |                                     |              |
| ACV, BTR (R-145BM)                  | 1                 | 18                 |                  |                    |                                     | 19           |
| <b>WEAPONS</b>                      |                   |                    |                  |                    |                                     |              |
| SCUD TEL                            |                   | 18                 |                  |                    |                                     | 18           |
| SAM, Shoulder-Fired                 | 3                 | 18                 |                  |                    | 3                                   | 24           |
| <b>ENGINEER EQUIPMENT</b>           |                   |                    |                  |                    |                                     |              |
| Route-Clearing Vehicle, BAT/PKT     |                   |                    |                  | 6                  |                                     | 6            |
| Ditching Machine, PZM/MDK           |                   |                    |                  | 4                  |                                     | 4            |
| <b>TRUCKS</b>                       |                   |                    |                  |                    |                                     |              |
| Truck, Utility                      | 3                 | 3                  | 5                | 2                  |                                     | 13           |
| Truck, Light                        | 1                 |                    | 3                |                    |                                     | 4            |
| Truck, Medium                       | 1                 | 36                 | 1                | 6                  | 30                                  | 74           |
| Truck, Heavy                        |                   |                    |                  | 4                  |                                     | 4            |
| Truck, Propellant                   |                   |                    |                  |                    | 6                                   | 6            |
| Truck, Oxidizer                     |                   |                    |                  |                    | 3                                   | 3            |
| Truck, Decon, ARS-12U/14            |                   | 3                  |                  |                    | 1                                   | 4            |
| Truck, Crane Shovel                 |                   |                    |                  | 2                  |                                     | 2            |
| Truck, Crane                        |                   | 3                  |                  |                    | 3                                   | 6            |
| Truck, POL (5,000-L)                |                   | 6                  |                  | 3                  | 1                                   | 10           |
| Truck, Water (2,000-L)              |                   | 3                  |                  |                    | 2                                   | 5            |
| Van, Command                        | 1                 |                    |                  |                    |                                     | 1            |
| Van, Signal                         |                   | 9                  | 10               |                    |                                     | 19           |
| Van, Survey                         |                   | 3                  |                  |                    |                                     | 3            |
| Ambulance                           |                   | 3                  |                  | 1                  | 1                                   | 5            |
| <b>TRAILERS</b>                     |                   |                    |                  |                    |                                     |              |
| Trailer, Cargo, 1-Axle              | 1                 | 3                  | 1                |                    | 1                                   | 6            |
| Trailer, Cargo, 2-Axle              |                   | 6                  |                  | 2                  | 2                                   | 10           |
| Trailer, Generator                  |                   | 18                 |                  | 1                  | 3                                   | 22           |
| Trailer, Kitchen                    |                   | 3                  | 1                | 1                  | 1                                   | 6            |
| Trailer, POL (4,200-L)              |                   | 6                  |                  | 3                  | 1                                   | 10           |
| Trailer, Water (900-/1,200-L)       |                   | 3                  | 1                | 1                  | 2                                   | 7            |
| Trailer, Missile Transporter        |                   | 9                  |                  |                    | 9                                   | 18           |
| Trailer, Welding                    |                   |                    |                  | 1                  |                                     | 1            |
| <b>RADARS</b>                       |                   |                    |                  |                    |                                     |              |
| Radar, Meteorological, END TRAY     |                   | 3                  |                  |                    |                                     | 3            |
| <b>RADIOS</b>                       |                   |                    |                  |                    |                                     |              |
| VHF, Manpack, Low-Power             | 1                 | 70                 | 7                | 6                  | 18                                  | 102          |
| VHF, Portable, Low-Power            | 1                 | 3                  |                  |                    | 1                                   | 5            |
| VHF, Vehicle Mount, Medium-Power    | 1                 | 18                 | 1                | 3                  |                                     | 23           |
| HF, Manpack, Low-Power              | 1                 | 9                  | 2                | 1                  |                                     | 13           |
| HF, Vehicle Mount, Medium-Power     |                   |                    | 2                |                    |                                     | 2            |
| HF, Vehicle Mount, High-Power       | 1                 |                    | 1                |                    |                                     | 2            |
| HF/VHF, Vehicle Mount, Med-Power    | 1                 | 9                  | 8                |                    |                                     | 18           |
| HF/VHF, Vehicle Mount, High-Power   | 1                 |                    | 2                |                    |                                     | 3            |
| Radio Relay, VHF/UHF                |                   | 3                  | 2                |                    |                                     | 5            |
| Warning Receiver                    | 1                 | 3                  | 1                |                    | 1                                   | 6            |
| <b>MISCELLANEOUS</b>                |                   |                    |                  |                    |                                     |              |
| Motorcycle                          |                   |                    | 3                |                    |                                     | 3            |

## Engineer Troops, National

---

The Chief of Engineers in the General Staff/Ground Forces Headquarters controls several engineer units. The numbers and types of units at this level can vary widely, depending on the size and structure of the Ground Forces they support. The following organization chart represents the *types* of engineer units that may be available.

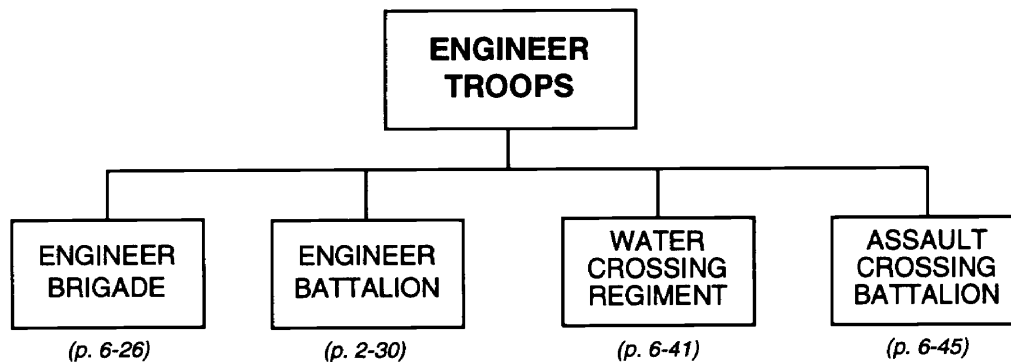

*NOTE:* The General Staff/Ground Forces Headquarters may allocate an entire regiment or brigade to support a military region or army. However, it may also allocate these assets as individual battalions.

Engineer Brigade,  
National or CDF

---

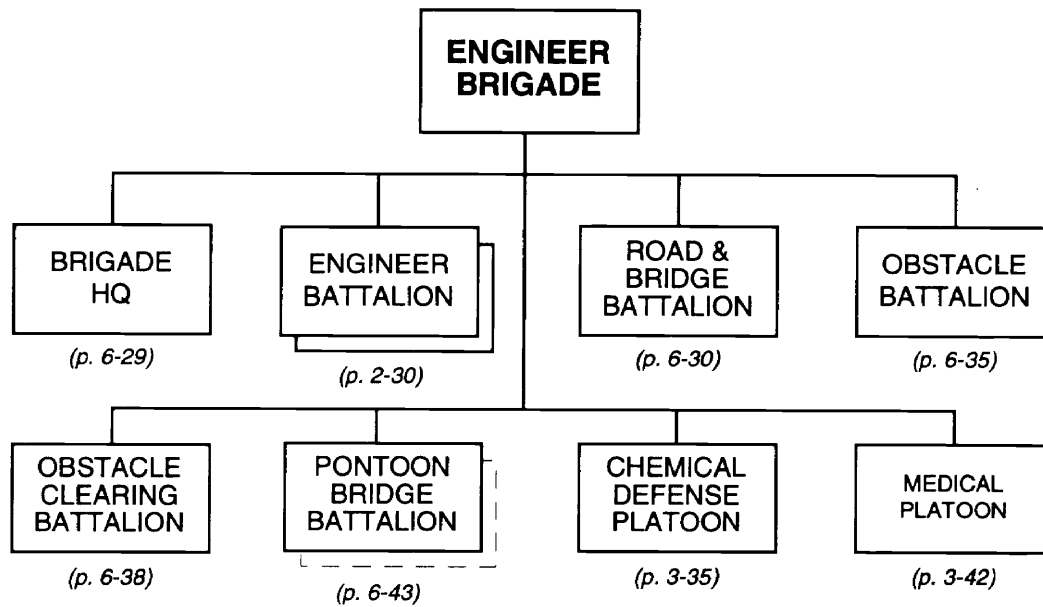

*NOTE:* Some engineer brigades may have a second pontoon bridge battalion. However, the equipment totals here include only one such battalion.

**(continued)**

## Engineer Brigade, National or CDF (continued)

|                                 |    |    |    |   |    |  |    |
|---------------------------------|----|----|----|---|----|--|----|
| Mine Detector, DIM              | 6  |    |    | 9 |    |  | 15 |
| Minelayer, PMR/GMZ*             | 6  |    | 27 |   |    |  | 33 |
| Armored Engineer Tractor, IMR   | 4  |    |    | 3 |    |  | 7  |
| Engineer Recon Vehicle, IRM     | 4  |    | 9  |   |    |  | 13 |
| Bridge, PMP Center**            | 32 |    |    |   | 32 |  | 64 |
| Bridge, PMP Ramp**              | 4  |    |    |   | 4  |  | 8  |
| Powerboat**                     | 12 |    |    |   | 12 |  | 24 |
| Bridge, Truck-Launched          | 16 | 16 |    |   |    |  | 32 |
| Bridge, Tank-Launched           | 8  | 12 |    |   |    |  | 20 |
| Tracked Amphibian, K-61/PTS     | 24 |    |    |   |    |  | 24 |
| Tracked Ferry, GSP/PMM-2 ***    | 12 |    |    |   |    |  | 12 |
| Assault Boat                    | 20 |    |    |   |    |  | 20 |
| Trailer, Amphibious, PKP        | 12 |    |    |   |    |  | 12 |
| Trailer, Compressor             | 2  |    |    |   |    |  | 2  |
| Route-Clearing Vehicle, BAT/PKT | 16 | 6  |    | 3 |    |  | 25 |
| Truck, Crane                    | 2  | 2  |    |   |    |  | 4  |
| Truck, Crane Shovel             | 10 | 2  |    |   |    |  | 12 |
| Truck, Dump                     | 6  | 4  |    |   |    |  | 10 |
| Truck, Sawmill                  | 2  | 2  |    |   |    |  | 4  |
| Trailer, Saw                    | 2  | 2  |    |   |    |  | 4  |
| Truck, Water Purification       | 2  | 2  |    |   |    |  | 4  |
| Concrete Mixer                  | 2  | 2  |    |   |    |  | 4  |
| Tractor                         | 4  | 3  |    |   |    |  | 7  |
| Piledriver Set, KMS             | 2  | 2  |    |   |    |  | 4  |
| Ditching Machine, PZM/MDK       | 8  | 4  | 9  |   |    |  | 21 |
| Grader                          | 4  | 5  |    |   |    |  | 9  |

**FOOTNOTES:**

\* When the armored tracked minelayer GMZ replaces the towed PMR, the unit need fewer trucks but has more VHF, vehicle mount, medium-power radios.

\*\* The PMM-2 amphibious bridge/ferry system may replace the PMP pontoon bridge. With the PMM-2, there is no need for powerboats.

\*\*\* With the GSP, 12 half-ferries form 6 ferries; with the PMM-2, there is only one vehicle per ferry.

(continued)

Engineer Brigade,  
National or CDF (continued)

| <i>Principal Items of Equipment</i> | <i>Brigade HQ</i> | <i>Engineer Bn (2x)</i> | <i>Road &amp; Bridge Bn</i> | <i>Obstacle Bn</i> | <i>Obstacle Clearing Bn</i> | <i>Pontoon Bridge Bn</i> | <i>Chemical Defense Plt</i> | <i>Medical Plt</i> | <i>TOTAL</i> |
|-------------------------------------|-------------------|-------------------------|-----------------------------|--------------------|-----------------------------|--------------------------|-----------------------------|--------------------|--------------|
| <b>TRUCKS</b>                       |                   |                         |                             |                    |                             |                          |                             |                    |              |
| Truck, Utility                      | 3                 | 18                      | 9                           | 7                  | 7                           | 6                        |                             |                    | 50           |
| Truck, Light                        | 4                 |                         |                             |                    |                             |                          |                             | 1                  | 5            |
| Truck, Medium*                      | 4                 | 60                      | 18                          | 40                 | 16                          | 4                        |                             | 2                  | 144          |
| Truck, Heavy                        |                   |                         | 6                           | 6                  | 6                           |                          |                             |                    | 18           |
| Truck, Decon, ARS-12U/14            |                   |                         |                             |                    |                             |                          | 3                           |                    | 3            |
| Truck, Decon, DDA-53/66             |                   |                         |                             |                    |                             |                          | 1                           | 1                  | 2            |
| Truck, POL (5,000-Liter)            | 1                 | 18                      | 7                           | 7                  | 3                           | 4                        |                             |                    | 40           |
| Truck, Recovery                     | 1                 |                         |                             |                    |                             |                          |                             |                    | 1            |
| Truck, Water (2,000-Liter)          |                   | 2                       | 1                           | 1                  | 1                           | 1                        | 2                           |                    | 8            |
| Van, Command                        | 3                 |                         |                             |                    |                             |                          |                             |                    | 3            |
| Van, Hospital                       |                   |                         |                             |                    |                             |                          |                             | 1                  | 1            |
| Van, Kitchen                        | 1                 | 2                       | 1                           | 1                  | 1                           | 1                        |                             |                    | 7            |
| Van, Maintenance                    | 4                 | 8                       | 4                           | 4                  | 4                           | 4                        |                             |                    | 28           |
| Van, Medium                         | 1                 | 2                       | 1                           | 1                  | 1                           | 1                        |                             |                    | 7            |
| Van, Signal                         | 1                 | 2                       | 1                           | 1                  | 1                           | 1                        |                             |                    | 7            |
| Ambulance                           |                   | 2                       | 1                           | 1                  | 1                           | 1                        |                             | 4                  | 10           |
| <b>TRAILERS</b>                     |                   |                         |                             |                    |                             |                          |                             |                    |              |
| Trailer, Cargo, 1-Axle              | 1                 | 8                       | 4                           | 1                  | 1                           | 1                        |                             |                    | 16           |
| Trailer, Cargo, 2-Axle              | 1                 | 6                       | 7                           | 1                  | 1                           | 1                        |                             |                    | 17           |
| Trailer, Generator                  | 1                 | 10                      | 3                           | 3                  | 3                           | 3                        |                             |                    | 23           |
| Trailer, Kitchen                    |                   | 12                      | 5                           | 4                  | 4                           | 3                        |                             | 1                  | 29           |
| Trailer, POL (4,200-L)              | 1                 | 18                      | 7                           | 7                  | 3                           | 4                        |                             |                    | 40           |
| Trailer, Water (900-/1,200-L)       | 1                 | 12                      | 5                           | 4                  | 4                           | 3                        | 2                           | 1                  | 32           |
| <b>RADIOS</b>                       |                   |                         |                             |                    |                             |                          |                             |                    |              |
| VHF, Manpack, Low-Power             | 6                 | 8                       | 22                          | 16                 | 28                          | 4                        |                             | 1                  | 85           |
| VHF, Vehicle Mount, Medium-Power    |                   | 54                      | 27                          | 15                 | 15                          | 11                       | 3                           |                    | 125          |
| HF, Manpack, Low-Power              |                   | 18                      | 1                           | 1                  | 1                           | 3                        | 1                           |                    | 25           |
| HF/VHF, Vehicle Mount, Med-Power    | 4                 | 4                       | 2                           | 2                  | 2                           | 2                        |                             |                    | 16           |
| HF/VHF, Vehicle Mount, High-Power   | 1                 | 2                       | 1                           | 1                  | 1                           | 1                        |                             |                    | 7            |
| Warning Receiver                    | 1                 | 2                       | 1                           | 1                  | 1                           | 1                        |                             |                    | 7            |

**FOOTNOTE:**

\* When the armored tracked minelayer GMZ replaces the towed PMR, the unit needs fewer trucks, but has more VHF, vehicle mount, medium-power radios.



**Brigade Headquarters,  
Engr Bde**

---

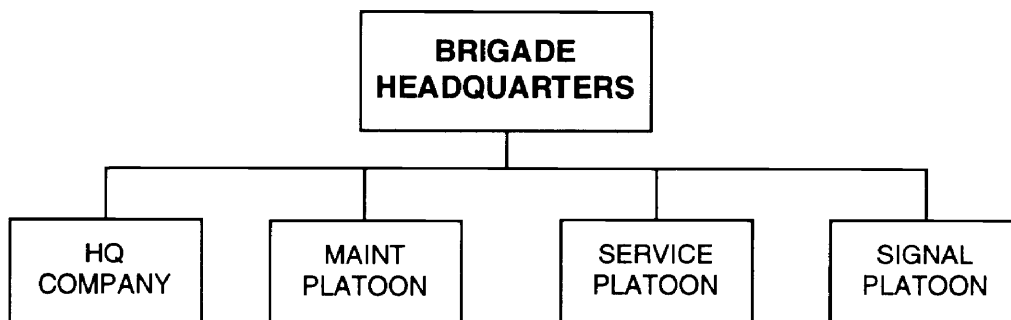

**PRINCIPAL ITEMS OF EQUIPMENT**

| <u>Equipment</u>              | <u>Total</u> | <u>Equipment</u>                 | <u>Total</u> |
|-------------------------------|--------------|----------------------------------|--------------|
| SAM, Shoulder-Fired.....      | 3            | Trailer, Cargo 2-Axle.....       | 1            |
| Truck, Utility .....          | 3            | Trailer, Generator.....          | 1            |
| Truck, Light .....            | 4            | Trailer, POL (4,200-Liter) ..... | 1            |
| Truck, Medium .....           | 4            | Trailer, Water (900-Liter) ..... | 1            |
| Truck, POL (5,000-Liter)..... | 1            | Radios:                          |              |
| Truck, Recovery.....          | 1            | VHF, Manpack, Low-Power.....     | 6            |
| Van, Command.....             | 3            | HF/VHF, Vehicle Mount,           |              |
| Van, Kitchen .....            | 1            | Medium-Power .....               | 4            |
| Van, Maintenance .....        | 4            | HF/VHF, Vehicle Mount,           |              |
| Van, Medium .....             | 1            | High-Power.....                  | 1            |
| Van, Signal.....              | 1            | Radio Relay, VHF/UHF.....        | 1            |
| Trailer, Cargo 1-Axle.....    | 1            | Warning Receiver .....           | 1            |

Road and Bridge Battalion,  
Engr Bde \_\_\_\_\_

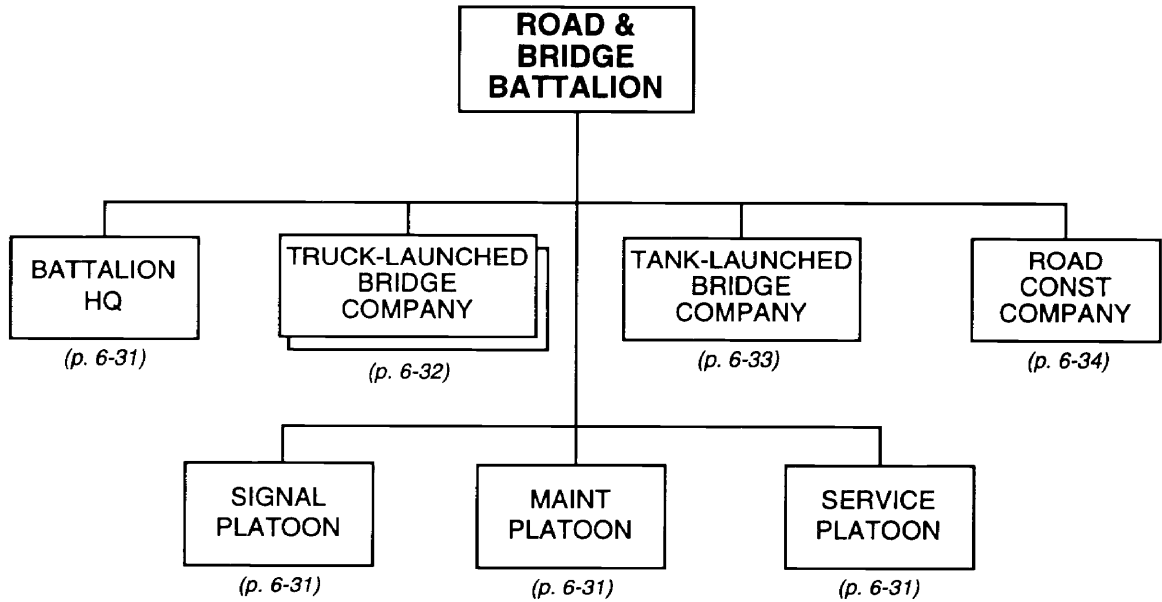

(continued)

**Road and Bridge Battalion,  
Engr Bde (continued)**

| <i>Principal Items of Equipment</i> | <i>Battalion HQ</i> | <i>Truck-Launched Bridge Co (2x)</i> | <i>Tank-Launched Bridge Co</i> | <i>Road Const Co</i> | <i>Signal Plt</i> | <i>Maintenance Plt</i> | <i>Service Plt</i> | <i>TOTAL</i> |
|-------------------------------------|---------------------|--------------------------------------|--------------------------------|----------------------|-------------------|------------------------|--------------------|--------------|
| <b>ARMORED VEHICLES</b>             |                     |                                      |                                |                      |                   |                        |                    |              |
| Armored Recovery Vehicle            |                     |                                      |                                |                      |                   | 3                      |                    | 3            |
| <b>WEAPONS</b>                      |                     |                                      |                                |                      |                   |                        |                    |              |
| SAM, Shoulder-Fired                 |                     | 6                                    | 3                              |                      |                   |                        |                    | 9            |
| <b>ENGINEER EQUIPMENT</b>           |                     |                                      |                                |                      |                   |                        |                    |              |
| Bridge, Truck-Launched              |                     | 16                                   |                                |                      |                   |                        |                    | 16           |
| Bridge, Tank-Launched               |                     |                                      | 12                             |                      |                   |                        |                    | 12           |
| Route-Clearing Vehicle, BAT/PKT     |                     |                                      |                                | 6                    |                   |                        |                    | 6            |
| Truck, Crane                        |                     |                                      |                                | 2                    |                   |                        |                    | 2            |
| Truck, Crane Shovel                 |                     |                                      |                                | 2                    |                   |                        |                    | 2            |
| Truck, Dump                         |                     |                                      |                                | 4                    |                   |                        |                    | 4            |
| Truck, Sawmill                      |                     |                                      |                                | 2                    |                   |                        |                    | 2            |
| Trailer, Saw                        |                     |                                      |                                | 2                    |                   |                        |                    | 2            |
| Truck, Water Purification           |                     |                                      |                                | 2                    |                   |                        |                    | 2            |
| Concrete Mixer                      |                     |                                      |                                | 2                    |                   |                        |                    | 2            |
| Tractor                             |                     |                                      |                                | 3                    |                   |                        |                    | 3            |
| Piledriver Set, KMS                 |                     |                                      |                                | 2                    |                   |                        |                    | 2            |
| Ditching Machine, PZM/MDK           |                     |                                      |                                | 4                    |                   |                        |                    | 4            |
| Grader                              |                     |                                      |                                | 5                    |                   |                        |                    | 5            |
| <b>TRUCKS</b>                       |                     |                                      |                                |                      |                   |                        |                    |              |
| Truck, Utility                      | 2                   | 2                                    | 1                              | 2                    | 1                 |                        | 1                  | 9            |
| Truck, Medium                       | 1                   | 6                                    | 2                              | 6                    | 1                 | 1                      | 1                  | 18           |
| Truck, Heavy                        |                     | 2                                    |                                | 4                    |                   |                        |                    | 6            |
| Truck, POL (5,000-Liter)            |                     |                                      |                                |                      |                   |                        | 7                  | 7            |
| Truck, Water (2,000-Liter)          |                     |                                      |                                |                      |                   |                        | 1                  | 1            |
| Van, Kitchen                        |                     |                                      |                                |                      |                   |                        | 1                  | 1            |
| Van, Maintenance                    |                     |                                      |                                |                      |                   | 4                      |                    | 4            |
| Van, Medium                         |                     |                                      |                                |                      |                   |                        | 1                  | 1            |
| Van, Signal                         |                     |                                      |                                |                      | 1                 |                        |                    | 1            |
| Ambulance                           |                     |                                      |                                |                      |                   |                        | 1                  | 1            |
| <b>TRAILERS</b>                     |                     |                                      |                                |                      |                   |                        |                    |              |
| Trailer, Cargo, 1-Axle              | 1                   |                                      |                                | 3                    |                   |                        |                    | 4            |
| Trailer, Cargo, 2-Axle              |                     |                                      |                                | 6                    |                   | 1                      |                    | 7            |
| Trailer, Generator                  |                     |                                      |                                |                      | 1                 | 1                      | 1                  | 3            |
| Trailer, Kitchen                    |                     | 2                                    | 1                              | 1                    |                   |                        | 1                  | 5            |
| Trailer, POL (4,200-L)              |                     |                                      |                                |                      |                   |                        | 7                  | 7            |
| Trailer, Water (900-/1,200-L)       |                     | 2                                    | 1                              | 1                    |                   |                        | 1                  | 5            |
| <b>RADIOS</b>                       |                     |                                      |                                |                      |                   |                        |                    |              |
| VHF, Manpack, Low-Power             |                     | 8                                    | 4                              | 6                    |                   | 3                      | 1                  | 22           |
| VHF, Vehicle Mount, Medium-Power    |                     | 8                                    | 12                             | 4                    |                   | 3                      |                    | 27           |
| HF, Manpack, Low-Power              | 1                   |                                      |                                |                      |                   |                        |                    | 1            |
| HF/VHF, Vehicle Mount, Med-Power    | 1                   |                                      |                                |                      | 1                 |                        |                    | 2            |
| HF/VHF, Vehicle Mount, High-Power   |                     |                                      |                                |                      | 1                 |                        |                    | 1            |
| Warning Receiver                    | 1                   |                                      |                                |                      |                   |                        |                    | 1            |

Truck-Launched Bridge Company,  
Road and Bridge Bn

---

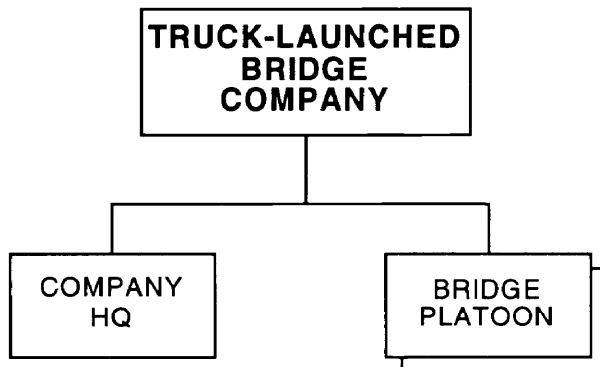

**PRINCIPAL ITEMS OF EQUIPMENT**

| <u>Equipment</u>             | <u>Total</u> |
|------------------------------|--------------|
| Bridge, Truck-Launched ..... | 8            |
| SAM, Shoulder-Fired.....     | 3            |
| Truck, Utility .....         | 1            |
| Truck, Medium .....          | 3            |
| Truck, Heavy.....            | 1            |
| Trailer, Kitchen.....        | 1            |

| <u>Equipment</u>                          | <u>Total</u> |
|---|--------------|
| Trailer, Water (900-Liter) .....          | 1            |
| Radios:                                   |              |
| VHF, Manpack, Low-Power.....              | 4            |
| VHF, Vehicle Mount,<br>Medium-Power ..... | 4            |

**Tank-Launched Bridge Company,  
Road and Bridge Bn**

---

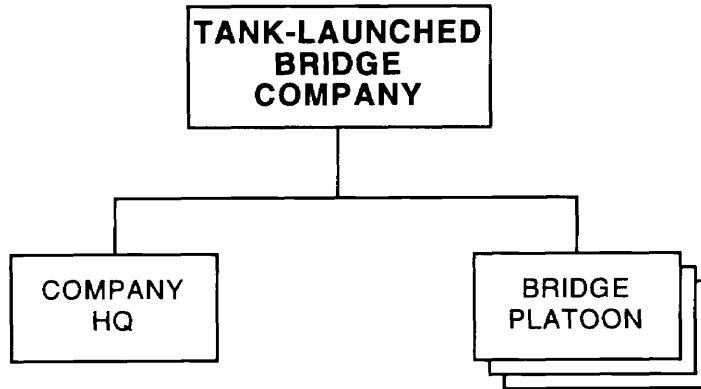

**PRINCIPAL ITEMS OF EQUIPMENT**

| <u>Equipment</u>            | <u>Total</u> | <u>Equipment</u>                 | <u>Total</u> |
|-----------------------------|--------------|----------------------------------|--------------|
| Bridge, Tank-Launched ..... | 12           | Trailer, Water (900-Liter) ..... | 1            |
| SAM, Shoulder-Fired.....    | 3            | Radios:                          |              |
| Truck, Utility .....        | 1            | VHF, Manpack, Low-Power.....     | 4            |
| Truck, Medium .....         | 2            | VHF, Vehicle Mount,              |              |
| Trailer, Kitchen.....       | 1            | Medium-Power .....               | 12           |

Road Construction Company,  
Road and Bridge Bn \_\_\_\_\_

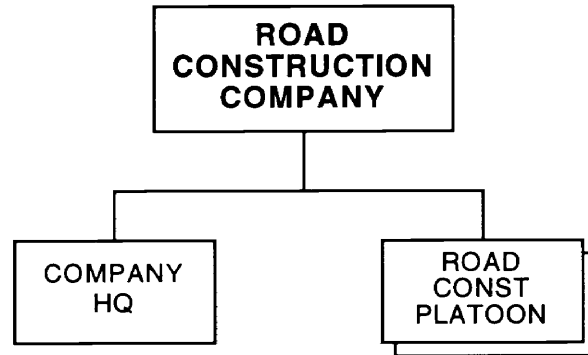

**PRINCIPAL ITEMS OF EQUIPMENT**

| <u>Equipment</u>                     | <u>Total</u> |
|--------------------------------------|--------------|
| Route-Clearing Vehicle, BAT/PKT..... | 6            |
| Grader .....                         | 5            |
| Truck, Crane .....                   | 2            |
| Truck, Crane Shovel .....            | 2            |
| Truck, Dump.....                     | 4            |
| Truck, Sawmill .....                 | 2            |
| Truck, Water Purification .....      | 2            |
| Ditching Machine, PZM/MDK.....       | 4            |
| Concrete Mixer .....                 | 2            |
| Piledriver Set, KMS.....             | 2            |
| Tractor 3                            |              |
| Truck, Utility .....                 | 2            |

| <u>Equipment</u>                          | <u>Total</u> |
|---|--------------|
| Truck, Medium .....                       | 6            |
| Truck, Heavy.....                         | 4            |
| Trailer, Cargo, 1-Axle.....               | 3            |
| Trailer, Cargo, 2-Axle.....               | 6            |
| Trailer, Kitchen.....                     | 1            |
| Trailer, Saw.....                         | 2            |
| Trailer, Water (900-Liter) .....          | 1            |
| Radios:                                   |              |
| VHF, Manpack, Low-Power.....              | 6            |
| VHF, Vehicle Mount,<br>Medium-Power ..... | 4            |

Obstacle Battalion,  
Engr Bde

---

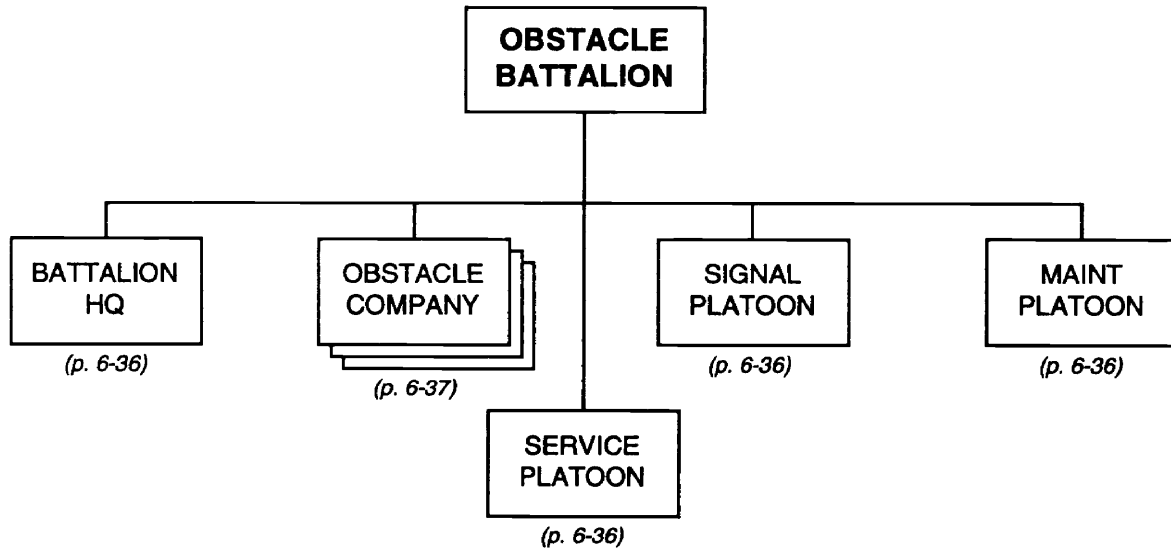

(continued)

**Obstacle Battalion,  
Engr Bde (continued)**

---

| <i>Principal Items of<br/>Equipment</i> | <i>Battalion HQ</i> | <i>Obstacle Co (3x)</i> | <i>Signal Plt</i> | <i>Maintenance Plt</i> | <i>Service Plt</i> | <i>TOTAL</i> |
|---|---------------------|-------------------------|-------------------|------------------------|--------------------|--------------|
| <b>ARMORED VEHICLES</b>                 |                     |                         |                   |                        |                    |              |
| APC, BTR-60/70/80                       |                     | 3                       |                   |                        |                    | 3            |
| Armored Recovery Vehicle                |                     |                         |                   | 3                      |                    | 3            |
| <b>WEAPONS</b>                          |                     |                         |                   |                        |                    |              |
| ATRL, RPG-18/22                         |                     | 12                      |                   |                        |                    | 12           |
| <b>ENGINEER EQUIPMENT</b>               |                     |                         |                   |                        |                    |              |
| Engineer Recon Vehicle, IRM             |                     | 9                       |                   |                        |                    | 9            |
| Minelayer, PMR/GMZ*                     |                     | 27                      |                   |                        |                    | 27           |
| Ditching Machine, PZM/MDK               |                     | 9                       |                   |                        |                    | 9            |
| <b>TRUCKS</b>                           |                     |                         |                   |                        |                    |              |
| Truck, Utility                          | 2                   | 3                       | 1                 |                        | 1                  | 7            |
| Truck, Medium*                          | 1                   | 36                      | 1                 | 1                      | 1                  | 40           |
| Truck, Heavy                            |                     | 6                       |                   |                        |                    | 6            |
| Truck, POL (5,000-Liter)                |                     |                         |                   |                        | 7                  | 7            |
| Truck, Water (2,000-Liter)              |                     |                         |                   |                        | 1                  | 1            |
| Van, Kitchen                            |                     |                         |                   |                        | 1                  | 1            |
| Van, Maintenance                        |                     |                         |                   | 4                      |                    | 4            |
| Van, Medium                             |                     |                         |                   |                        | 1                  | 1            |
| Van, Signal                             |                     |                         | 1                 |                        |                    | 1            |
| Ambulance                               |                     |                         |                   |                        | 1                  | 1            |
| <b>TRAILERS</b>                         |                     |                         |                   |                        |                    |              |
| Trailer, Cargo, 1-Axle                  | 1                   |                         |                   |                        |                    | 1            |
| Trailer, Cargo, 2-Axle                  |                     |                         |                   | 1                      |                    | 1            |
| Trailer, Generator                      |                     |                         | 1                 | 1                      | 1                  | 3            |
| Trailer, Kitchen                        |                     | 3                       |                   |                        | 1                  | 4            |
| Trailer, POL (4,200-L)                  |                     |                         |                   |                        | 7                  | 7            |
| Trailer, Water (900-/1,200-L)           |                     | 3                       |                   |                        | 1                  | 4            |
| <b>RADIOS</b>                           |                     |                         |                   |                        |                    |              |
| VHF, Manpack, Low-Power                 |                     | 12                      |                   | 3                      | 1                  | 16           |
| VHF, Vehicle Mount, Medium-Power*       |                     | 12                      |                   | 3                      |                    | 15           |
| HF, Manpack, Low-Power                  | 1                   |                         |                   |                        |                    | 1            |
| HF/VHF, Vehicle Mount, Med-Power        | 1                   |                         | 1                 |                        |                    | 2            |
| HF/VHF, Vehicle Mount, High-Power       |                     |                         | 1                 |                        |                    | 1            |
| Warning Receiver                        | 1                   |                         |                   |                        |                    | 1            |

**FOOTNOTE:**

\* When the armored tracked minelayer GMZ replaces the towed PMR, the obstacle battalion needs only 31 medium trucks, but has a total of 24 VHF, vehicle mount, medium power radios.



Obstacle Company,  
Obstacle Bn

---

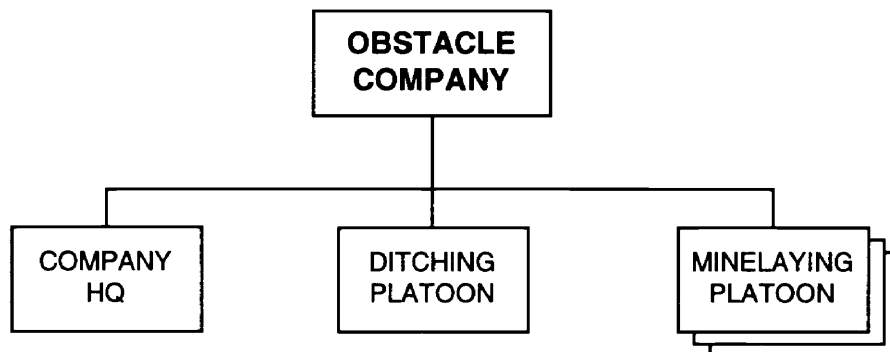

**PRINCIPAL ITEMS OF EQUIPMENT**

| <u>Equipment</u>                 | <u>Total</u> | <u>Equipment</u>                | <u>Total</u> |
|----------------------------------|--------------|---------------------------------|--------------|
| APC, BTR-60/70/80 .....          | 1            | Truck, Heavy.....               | 2            |
| ATRL, RPG-18/22.....             | 4            | Trailer, Kitchen.....           | 1            |
| Engineer Recon Vehicle, IRM..... | 3            | Trailer, Water (900-Liter)..... | 1            |
| Minelayer, PMR/GMZ*.....         | 9            | Radios:                         |              |
| Ditching Machine, PZM/MDK.....   | 3            | VHF, Manpack, Low-Power.....    | 4            |
| Truck, Utility .....             | 1            | VHF, Vehicle Mount,             |              |
| Truck, Medium* .....             | 12           | Medium-Power* .....             | 4            |

**FOOTNOTE:** \* When the armored tracked minelayer, GMZ, replaces the towed PMR, the obstacle company needs only nine medium trucks, but has a total of seven VHF, vehicle mount, medium-power radios.

Obstacle Clearing Battalion,  
Engr Bde

---

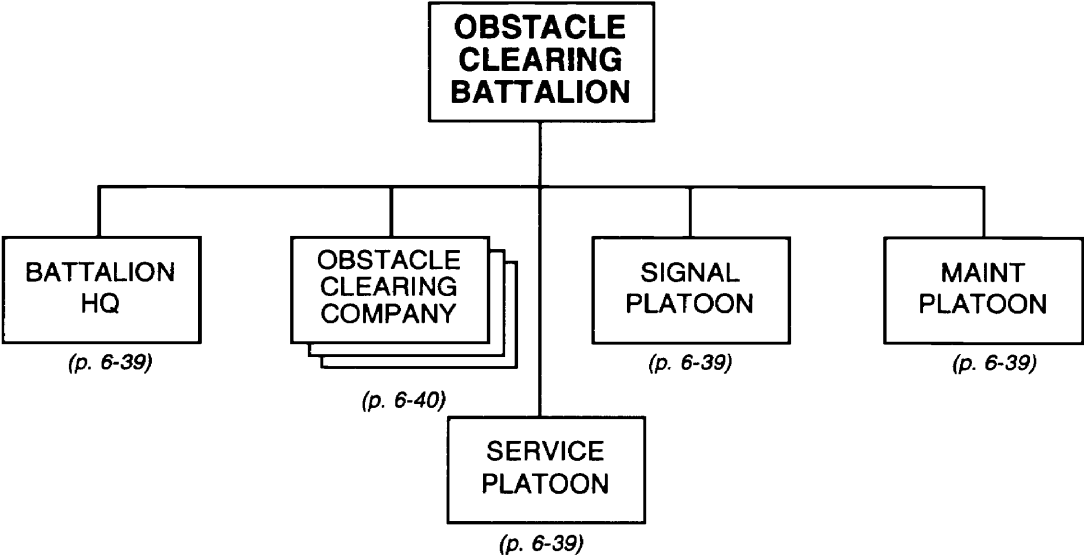

(continued)

## Obstacle Clearing Battalion, Engr Bde (continued)

| <i>Principal Items of Equipment</i> | <i>Battalion HQ</i> | <i>Obstacle Clearing Co (3x)</i> | <i>Signal Plt</i> | <i>Maintenance Plt</i> | <i>Service Plt</i> | <i>TOTAL</i> |
|-------------------------------------|---------------------|----------------------------------|-------------------|------------------------|--------------------|--------------|
| <b>ARMORED VEHICLES</b>             |                     |                                  |                   |                        |                    |              |
| APC, BTR-60/70/80                   |                     | 3                                |                   |                        |                    | 3            |
| Armored Recovery Vehicle            |                     |                                  |                   | 3                      |                    | 3            |
| <b>WEAPONS</b>                      |                     |                                  |                   |                        |                    |              |
| ATRL, RPG-18/22                     |                     | 12                               |                   |                        |                    | 12           |
| <b>ENGINEER EQUIPMENT</b>           |                     |                                  |                   |                        |                    |              |
| Armored Engineer Tractor, IMR       |                     | 3                                |                   |                        |                    | 3            |
| Mine Detector, DIM                  |                     | 9                                |                   |                        |                    | 9            |
| Mineclearer, MTK/MTK-2              |                     | 9                                |                   |                        |                    | 9            |
| Route-Clearing Vehicle, BAT/PKT     |                     | 3                                |                   |                        |                    | 3            |
| <b>TRUCKS</b>                       |                     |                                  |                   |                        |                    |              |
| Truck, Utility                      | 2                   | 3                                | 1                 |                        | 1                  | 7            |
| Truck, Medium                       | 1                   | 12                               | 1                 | 1                      | 1                  | 16           |
| Truck, Heavy                        |                     | 6                                |                   |                        |                    | 6            |
| Truck, POL (5,000-Liter)            |                     |                                  |                   |                        | 3                  | 3            |
| Truck, Water (2,000-Liter)          |                     |                                  |                   |                        | 1                  | 1            |
| Van, Kitchen                        |                     |                                  |                   |                        | 1                  | 1            |
| Van, Maintenance                    |                     |                                  |                   | 4                      |                    | 4            |
| Van, Medium                         |                     |                                  |                   |                        | 1                  | 1            |
| Van, Signal                         |                     |                                  | 1                 |                        |                    | 1            |
| Ambulance                           |                     |                                  |                   |                        | 1                  | 1            |
| <b>TRAILERS</b>                     |                     |                                  |                   |                        |                    |              |
| Trailer, Cargo, 1-Axle              | 1                   |                                  |                   |                        |                    | 1            |
| Trailer, Cargo, 2-Axle              |                     |                                  |                   | 1                      |                    | 1            |
| Trailer, Generator                  |                     |                                  | 1                 | 1                      | 1                  | 3            |
| Trailer, Kitchen                    |                     | 3                                |                   |                        | 1                  | 4            |
| Trailer, POL (4,200-L)              |                     |                                  |                   |                        | 3                  | 3            |
| Trailer, Water (900-/1,200-L)       |                     | 3                                |                   |                        | 1                  | 4            |
| <b>RADIOS</b>                       |                     |                                  |                   |                        |                    |              |
| VHF, Manpack, Low-Power             |                     | 24                               |                   | 3                      | 1                  | 28           |
| VHF, Vehicle Mount, Medium-Power    |                     | 12                               |                   | 3                      |                    | 15           |
| HF, Manpack, Low-Power              | 1                   |                                  |                   |                        |                    | 1            |
| HF/VHF, Vehicle Mount, Med-Power    | 1                   |                                  | 1                 |                        |                    | 2            |
| HF/VHF, Vehicle Mount, High-Power   |                     |                                  | 1                 |                        |                    | 1            |
| Warning Receiver                    | 1                   |                                  |                   |                        |                    | 1            |

Obstacle Clearing Company,  
Obstacle Clearing Bn \_\_\_\_\_

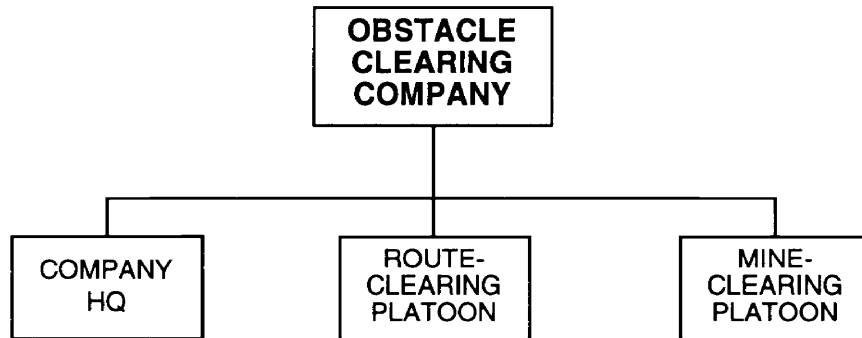

**PRINCIPAL ITEMS OF EQUIPMENT**

| <u>Equipment</u>                     | <u>Total</u> |
|--------------------------------------|--------------|
| APC, BTR-60/70/80 .....              | 1            |
| ATRL, RPG-18/22.....                 | 4            |
| Armored Engineer Tractor, IMR .....  | 1            |
| Mine Detector, DIM.....              | 3            |
| Mineclearer, MTK/MTK-2.....          | 3            |
| Route-Clearing Vehicle, BAT/PKT..... | 1            |
| Truck, Utility .....                 | 1            |
| Truck, Medium .....                  | 4            |

| <u>Equipment</u>                          | <u>Total</u> |
|---|--------------|
| Truck, Heavy.....                         | 2            |
| Trailer, Kitchen.....                     | 1            |
| Trailer, Water (900-Liter) .....          | 1            |
| Radios:                                   |              |
| VHF, Manpack, Low-Power.....              | 8            |
| VHF, Vehicle Mount,<br>Medium-Power ..... | 4            |

**Water Crossing Regiment,  
National**

---

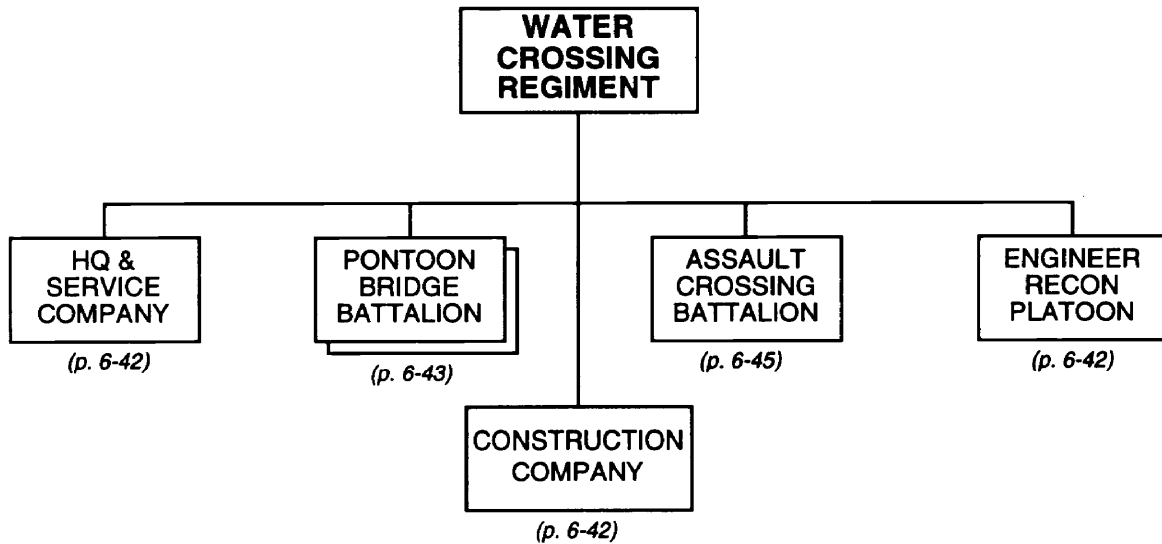

*NOTE:* Equipment totals are for a regiment with two pontoon bridge battalions. If the regiment has a third pontoon bridge battalion, it may not have the assault crossing battalion shown here.

**(continued)**

## Water Crossing Regiment, National (continued)

| <i>Principal Items of Equipment</i> | <i>HQ &amp; Services Co</i> | <i>Pontoon Bridge Bn (2x)</i> | <i>Assault Crossing Bn</i> | <i>Engineer Recon Plt</i> | <i>Constuction Co</i> | <i>TOTAL</i> |
|-------------------------------------|-----------------------------|-------------------------------|----------------------------|---------------------------|-----------------------|--------------|
| <b>ARMORED VEHICLES</b>             |                             |                               |                            |                           |                       |              |
| ACV, BRDM-2U                        |                             |                               | 4                          |                           |                       | 4            |
| APC, BTR-60/70/80                   |                             |                               |                            | 3                         |                       | 3            |
| Armored Recovery Vehicle            |                             | 6                             | 3                          |                           |                       | 9            |
| <b>WEAPONS</b>                      |                             |                               |                            |                           |                       |              |
| SAM, Shoulder-Fired                 | 3                           | 18                            | 4                          |                           |                       | 25           |
| <b>ENGINEER EQUIPMENT</b>           |                             |                               |                            |                           |                       |              |
| Engineer Recon Vehicle, IRM         |                             |                               | 3                          | 2                         |                       | 5            |
| Armored Engineer Tractor, IMR       |                             |                               | 3                          |                           |                       | 3            |
| Ditching Machine, PZM/BTM/MDK       |                             |                               | 3                          |                           | 4                     | 7            |
| Route-Clearing Vehicle, BAT/PKT     |                             |                               | 3                          |                           | 4                     | 7            |
| Mine Detector, DIM                  |                             |                               |                            | 1                         |                       | 1            |
| Bridge, Truck-Launched              |                             |                               |                            |                           | 4                     | 4            |
| Tracked Amphibian, K-61/PTS         |                             |                               | 36                         |                           |                       | 36           |
| Trailer, Amphibious, PKP            |                             |                               | 18                         |                           |                       | 18           |
| Tracked Ferry, GSP/PMM-2*           |                             |                               | 36                         |                           |                       | 36           |
| Bridge, PMP Center**                |                             | 64                            |                            |                           |                       | 64           |
| Bridge, PMP Ramp**                  |                             | 8                             |                            |                           |                       | 8            |
| Powerboat**                         |                             | 24                            |                            |                           |                       | 24           |
| <b>TRUCKS</b>                       |                             |                               |                            |                           |                       |              |
| Truck, Utility                      | 3                           | 12                            | 2                          | 2                         | 1                     | 20           |
| Truck, Light                        | 4                           |                               |                            |                           |                       | 4            |
| Truck, Medium                       | 4                           | 8                             | 10                         | 1                         | 13                    | 36           |
| Truck, Heavy                        |                             |                               |                            |                           | 5                     | 5            |
| Truck, Crane                        | 1                           |                               | 3                          |                           |                       | 4            |
| Truck, Crane Shovel                 |                             | 4                             |                            |                           | 2                     | 6            |
| Truck, Dump                         |                             |                               |                            |                           | 1                     | 1            |
| Truck, POL (5,000-L)                | 1                           | 8                             | 11                         |                           |                       | 20           |
| Truck, Recovery                     | 1                           |                               |                            |                           |                       | 1            |
| Truck, Water (2,000-L)              |                             | 2                             |                            |                           |                       | 2            |
| Van, Command                        | 3                           |                               |                            |                           |                       | 3            |
| Van, Kitchen                        | 1                           | 2                             |                            |                           |                       | 3            |
| Van, Maintenance                    | 4                           | 8                             |                            |                           |                       | 12           |
| Van, Medium                         | 1                           | 2                             |                            |                           |                       | 3            |
| Van, Signal                         | 1                           | 2                             |                            |                           |                       | 3            |
| Ambulance                           | 1                           | 2                             |                            |                           |                       | 3            |
| <b>TRAILERS</b>                     |                             |                               |                            |                           |                       |              |
| Trailer, Cargo, 1-Axle              | 1                           | 2                             |                            |                           |                       | 3            |
| Trailer, Cargo, 2-Axle              | 1                           | 2                             | 5                          |                           | 2                     | 10           |
| Trailer, Generator                  | 1                           | 6                             |                            |                           | 1                     | 8            |
| Trailer, Kitchen                    |                             | 6                             | 1                          |                           | 1                     | 8            |
| Trailer, POL (1,200-L)              |                             |                               |                            | 2                         |                       | 2            |
| Trailer, POL (4,200-L)              | 1                           | 8                             | 11                         |                           |                       | 20           |
| Trailer, Water (900-L)              | 1                           | 6                             | 1                          |                           | 1                     | 9            |
| <b>RADIOS</b>                       |                             |                               |                            |                           |                       |              |
| VHF, Manpack, Low-Power             | 6                           | 8                             | 4                          |                           |                       | 18           |
| VHF, Vehicle Mount, Med-Power       |                             | 22                            | 30                         | 5                         | 8                     | 65           |
| HF, Manpack, Low-Power              |                             | 6                             | 1                          | 3                         | 1                     | 11           |
| HF/VHF, Vehicle Mount, Med-Power    | 4                           | 4                             |                            |                           |                       | 8            |
| HF/VHF, Vehicle Mount, Hi-Power     | 1                           | 2                             |                            |                           |                       | 3            |
| Radio Relay, VHF/UHF                | 1                           |                               |                            |                           |                       | 1            |
| Warning Receiver                    | 1                           | 2                             | 1                          |                           |                       | 4            |

**FOOTNOTES:**

\* With the GSP, 12 half-ferris form 6 ferris;with the PMM-2, there is only one vehicle per ferry.

\*\* The PMM-2 amphibious bridge/ferry system may replace the PMP pontoon bridge. With the PMM-2, there is no need for powerboats.

**Pontoon Bridge Battalion,  
Water Crossing Regt or Engr Bde** \_\_\_\_\_

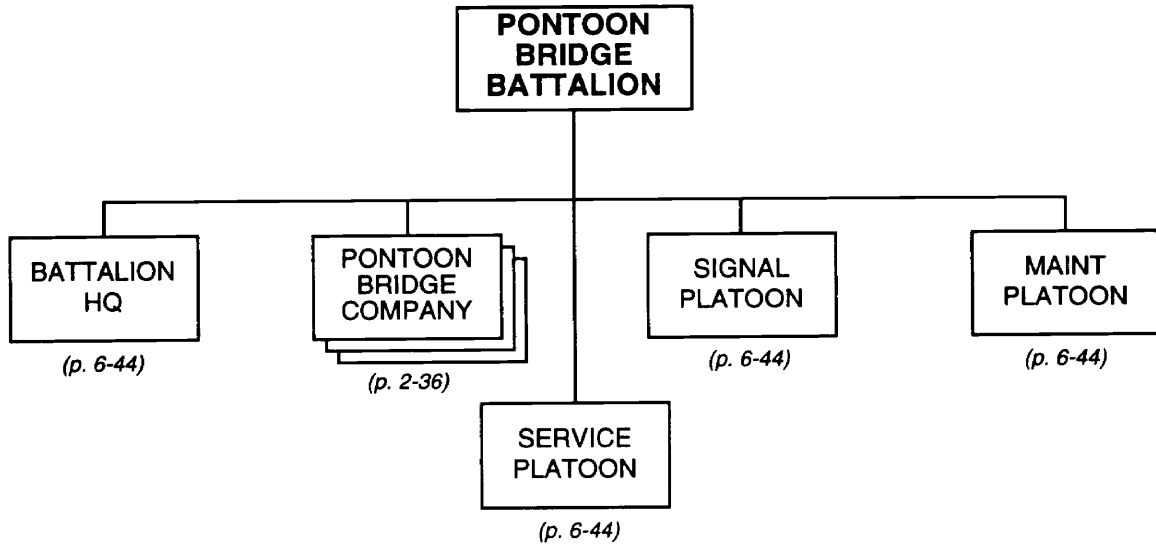

**(continued)**

Pontoon Bridge Battalion, Water Crossing Regt  
or Engr Bde (continued)

| <i>Principal Items of Equipment</i> | <i>Battalion HQ</i> | <i>Pontoon Bridge Co (2x)</i> | <i>Signal Plt</i> | <i>Maintenance Plt</i> | <i>Service Plt</i> | <i>TOTAL</i> |
|-------------------------------------|---------------------|-------------------------------|-------------------|------------------------|--------------------|--------------|
| <b>ARMORED VEHICLES</b>             |                     |                               |                   |                        |                    |              |
| Armored Recovery Vehicle            |                     |                               |                   | 3                      |                    | 3            |
| <b>WEAPONS</b>                      |                     |                               |                   |                        |                    |              |
| SAM, Shoulder-Fired                 |                     | 6                             |                   |                        |                    | 6            |
| <b>ENGINEER EQUIPMENT</b>           |                     |                               |                   |                        |                    |              |
| Bridge, PMP Center*                 |                     | 32                            |                   |                        |                    | 32           |
| Bridge, PMP Ramp*                   |                     | 4                             |                   |                        |                    | 4            |
| Powerboat*                          |                     | 12                            |                   |                        |                    | 12           |
| <b>TRUCKS</b>                       |                     |                               |                   |                        |                    |              |
| Truck, Utility                      | 2                   | 2                             | 1                 |                        | 1                  | 6            |
| Truck, Medium                       | 1                   |                               | 1                 | 1                      | 1                  | 4            |
| Truck, POL (5,000-Liter)            |                     |                               |                   |                        | 4                  | 4            |
| Truck, Water (2,000-Liter)          |                     |                               |                   |                        | 1                  | 1            |
| Van, Kitchen                        |                     |                               |                   |                        | 1                  | 1            |
| Van, Maintenance                    |                     |                               |                   | 4                      |                    | 4            |
| Van, Medium                         |                     |                               |                   |                        | 1                  | 1            |
| Van, Signal                         |                     |                               | 1                 |                        |                    | 1            |
| Ambulance                           |                     |                               |                   |                        | 1                  | 1            |
| <b>TRAILERS</b>                     |                     |                               |                   |                        |                    |              |
| Trailer, Cargo, 1-Axle              | 1                   |                               |                   |                        |                    | 1            |
| Trailer, Cargo, 2-Axle              |                     |                               |                   | 1                      |                    | 1            |
| Trailer, Generator                  |                     |                               | 1                 | 1                      | 1                  | 3            |
| Trailer, Kitchen                    |                     | 2                             |                   |                        | 1                  | 3            |
| Trailer, POL (4,200-L)              |                     |                               |                   |                        | 4                  | 4            |
| Trailer, Water (900-/1,200-L)       |                     | 2                             |                   |                        | 1                  | 3            |
| <b>RADIOS</b>                       |                     |                               |                   |                        |                    |              |
| VHF, Manpack, Low-Power             |                     |                               |                   | 3                      | 1                  | 4            |
| VHF, Vehicle Mount, Medium-Power    |                     | 8                             |                   | 3                      |                    | 11           |
| HF, Manpack, Low-Power              | 1                   | 2                             |                   |                        |                    | 3            |
| HF/VHF, Vehicle Mount, Med-Power    | 1                   |                               | 1                 |                        |                    | 2            |
| HF/VHF, Vehicle Mount, High-Power   |                     |                               | 1                 |                        |                    | 1            |
| Warning Receiver                    | 1                   |                               |                   |                        |                    | 1            |

**FOOTNOTE:**

\* The PMM-2 amphibious bridge/ferry system may replace the PMP pontoon bridge. With the PMM-2, there is no need for powerboats.



**Assault Crossing Battalion, National  
or Water Crossing Regt**

---

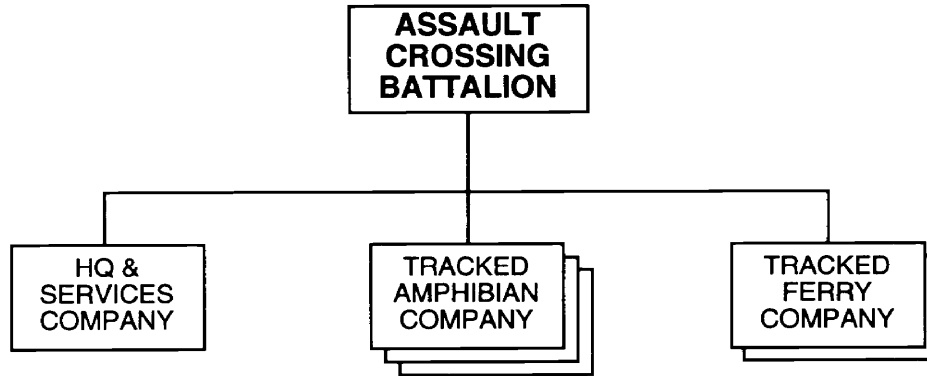

**PRINCIPAL ITEMS OF EQUIPMENT**

| <u>Equipment</u>                     | <u>Total</u> | <u>Equipment</u>                 | <u>Total</u> |
|--------------------------------------|--------------|----------------------------------|--------------|
| SAM, Shoulder-Fired.....             | 4            | Truck, Crane .....               | 3            |
| ACV, BRDM-2U .....                   | 4            | Truck, POL (5,000-Liter).....    | 11           |
| Armored Engineer Tractor, IMR .....  | 3            | Trailer, Cargo, 2-Axle.....      | 5            |
| Armored Recovery Vehicle .....       | 3            | Trailer, Kitchen.....            | 1            |
| Engineer Recon Vehicle, IRM.....     | 3            | Trailer, POL (4,200-Liter) ..... | 11           |
| Tracked Ferry, GSP/PMM-2* .....      | 36           | Trailer, Water (900-Liter) ..... | 1            |
| Tracked Amphibian, K-61/PTS .....    | 36           | Radios:                          |              |
| Trailer, Amphibious, PKP .....       | 18           | VHF, Manpack, Low-Power.....     | 4            |
| Ditching Machine, PMZ/BTM/MDK .....  | 3            | VHF, Vehicle Mount,              |              |
| Route-Clearing Vehicle, BAT/PKT..... | 3            | Medium-Power .....               | 30           |
| Truck, Utility .....                 | 2            | HF, Manpack, Low-Power.....      | 1            |
| Truck, Medium .....                  | 10           | Warning Receiver .....           | 1            |

*FOOTNOTE:* \* With the GSP, 12 half-ferries form 6 ferries; with the PMM-2, there is only one vehicle per ferry.

**Signal Troops,  
National**

---

The Chief of Signal Troops in the General Staff/Ground Forces Headquarters controls several signal units. The numbers and types of units at this level can vary widely, depending on the size and structure of the Ground Forces they support. The following organization chart represents the *types* of signal units that may be available.

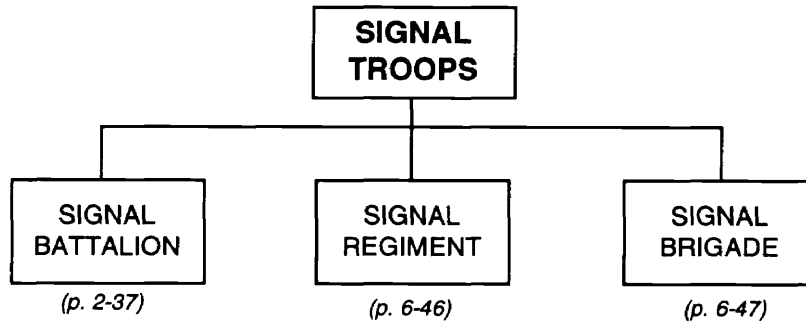

*NOTE:* The General Staff/Ground Forces Headquarters may allocate an entire regiment or brigade to support a military region or army. However, it may also allocate these assets as individual battalions.

**Signal Regiment,  
National**

---

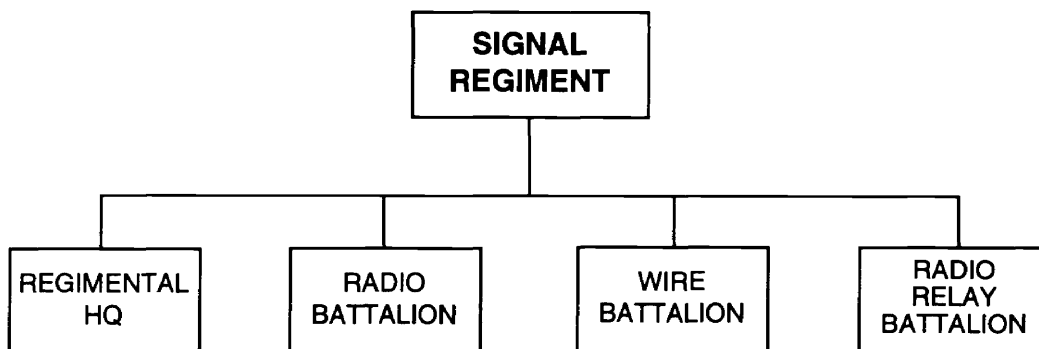

*NOTE:* Some signal regiments may have the structure shown above. However, most have three signal battalions identical to those organic to divisions and districts (p. 2-37). This facilitates support to tactical units.

**Signal Brigade,  
National**

---

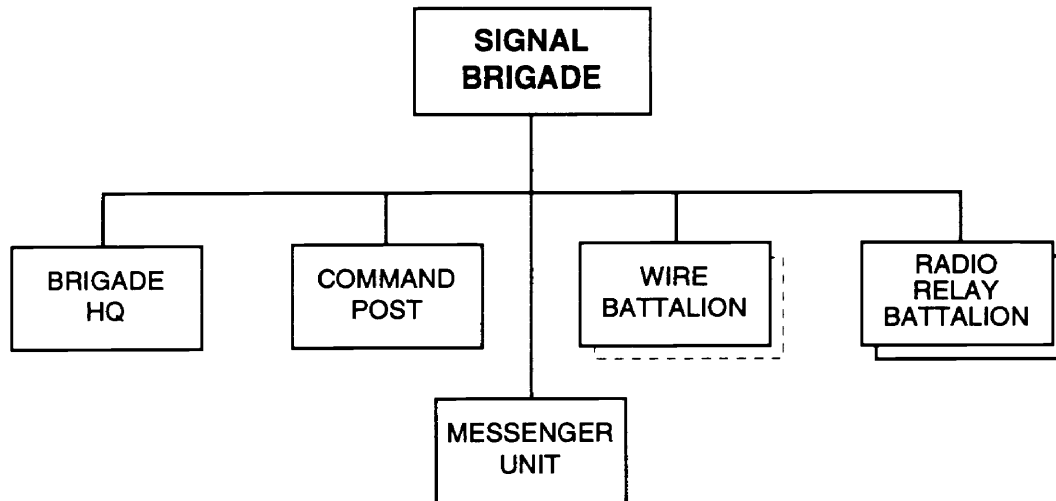

*NOTE:* Some signal brigades may have the structure shown above. However, most have three to four signal battalions identical to those organic to divisions and districts (p. 2-37). This facilitates support to tactical units.

**Chemical Troops,  
National**

---

The Chief of Chemical Troops in the General Staff/Ground Forces Headquarters controls several chemical defense and smoke units. The numbers and types of units at this level can vary widely, depending on the size and structure of the Ground Forces they support. The following organization chart represents the *types* of chemical defense and smoke units that may be available.

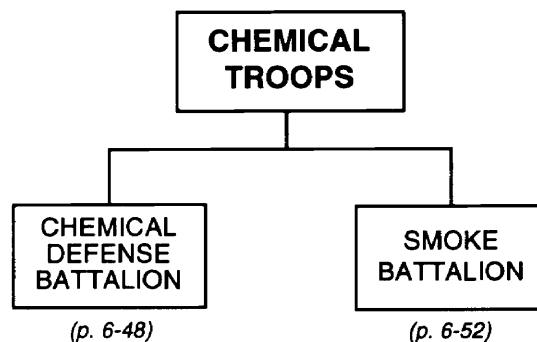

*NOTE:* The Staff/Ground Forces Headquarters may allocate an entire battalion to support a military region or army. However, it may also allocate these assets as individual companies.

**Chemical Defense Battalion,  
National**

---

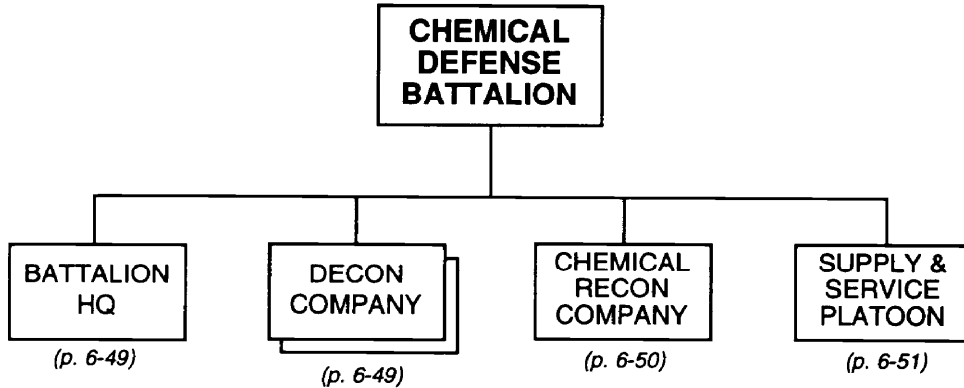

**PRINCIPAL ITEMS OF EQUIPMENT**

| <u>Equipment</u>                                | <u>Total</u> | <u>Equipment</u>                            | <u>Total</u> |
|---|--------------|---|--------------|
| Chemical Recon Vehicle,<br>BRDM-2RKh/RKhM ..... | 9            | Ambulance .....                             | 1            |
| Truck, Decon, ARS-12U/14 .....                  | 16           | Trailer, Cargo, 1-Axle.....                 | 2            |
| Truck, Decon, DDA-53/66 .....                   | 8            | Trailer, Cargo, 2-Axle.....                 | 6            |
| Truck, Decon, DKV .....                         | 2            | Trailer, Generator.....                     | 3            |
| Truck, Decon, TMS-65 .....                      | 2            | Trailer, Kitchen.....                       | 3            |
| Trailer, Decon, DDP .....                       | 4            | Trailer, POL (4,200-Liter) .....            | 4            |
| ATGL, RPG-7V .....                              | 5            | Trailer, Water (900-Liter) .....            | 6            |
| Truck, Utility .....                            | 3            | Radios:                                     |              |
| Truck, Light .....                              | 4            | VHF, Manpack, Low-Power.....                | 3            |
| Truck, Medium .....                             | 23           | VHF, Vehicle Mount,<br>Medium-Power .....   | 10           |
| Truck, POL (5,000-Liter).....                   | 4            | HF/VHF, Vehicle Mount<br>Medium-Power ..... | 1            |
| Truck, Water (2,000-Liter) .....                | 7            | HF, Manpack, Low-Power.....                 | 2            |
| Van, Light .....                                | 1            | Warning Receiver .....                      | 1            |
| Van, Maintenance .....                          | 2            |   |              |
| Van, Signal.....                                | 1            |   |              |

**Battalion Headquarters,  
Chem Def Bn**

---



**PRINCIPAL ITEMS OF EQUIPMENT**

| <u>Equipment</u>     | <u>Total</u> | <u>Equipment</u>            | <u>Total</u> |
|----------------------|--------------|-----------------------------|--------------|
| Truck, Utility ..... | 1            | Radios:                     |              |
| Van, Light .....     | 1            | VHF, Vehicle Mount,         |              |
| Van, Signal.....     | 1            | Medium-Power .....          | 1            |
|                      |              | HF/VHF, Vehicle Mount,      |              |
|                      |              | Medium-Power .....          | 1            |
|                      |              | HF, Manpack, Low-Power..... | 1            |
|                      |              | Warning Receiver .....      | 1            |

**Decontamination Company,  
Chem Def Bn**

---

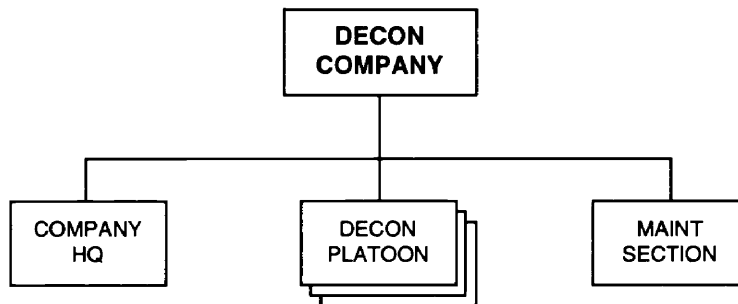

**PRINCIPAL ITEMS OF EQUIPMENT**

| <u>Equipment</u>                | <u>1st Co</u> | <u>2nd Co</u> | <u>Equipment</u>                 | <u>1st Co</u> | <u>2nd Co</u> |
|---------------------------------|---------------|---------------|----------------------------------|---------------|---------------|
| ATGL, RPG-7V .....              | 2             | 2             | Truck, Medium .....              | 6             | 6             |
| Truck, Decon, ARS-12U/14 .....  | 10            | 6             | Truck, Water (2,000-Liter) ..... | 3             | 3             |
| Truck, Decon, DDA-53/66 .....   | 2             | 2             | Trailer, Cargo, 1-Axle.....      | 2             | 0             |
| Truck, Decon, TMS-65 .....      | 2             | 0             | Trailer, Cargo, 2-Axle.....      | 0             | 2             |
| Decon System, Portable, DKV ... | 0             | 2             | Trailer, Water (900-Liter) ..... | 4             | 2             |
| Trailer, Decon, DDP .....       | 0             | 4             | Radio, VHF, Manpack,             |               |               |
| Truck, Light .....              | 2             | 2             | Low-Power.....                   | 1             | 1             |

*NOTE:* There are two types of decontamination companies. A chemical defense battalion normally has one of each type. The first is primarily for vehicle decontamination. The second is primarily for personnel decontamination.

Chemical Reconnaissance Company,  
Chem Def Bn

---

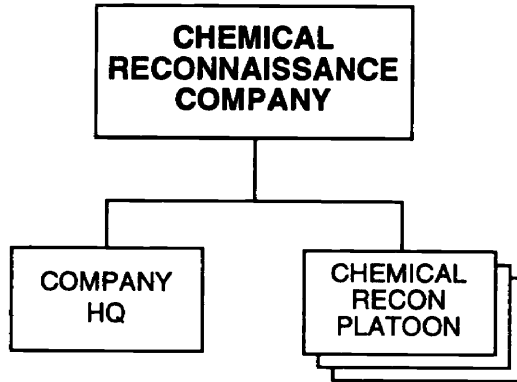

**PRINCIPAL ITEMS OF EQUIPMENT**

| <u>Equipment</u>                                | <u>Total</u> | <u>Equipment</u>                          | <u>Total</u> |
|---|--------------|---|--------------|
| ATGL, RPG-7V .....                              | 1            | Radios:                                   |              |
| Chemical Recon Vehicle,<br>BRDM-2RKh/RKhM ..... | 9            | VHF, Vehicle Mount,<br>Medium-Power ..... | 9            |
| Truck, Utility .....                            | 1            | HF, Manpack, Low-Power .....              | 1            |

**Supply and Service Platoon,  
Chem Def Bn**

---

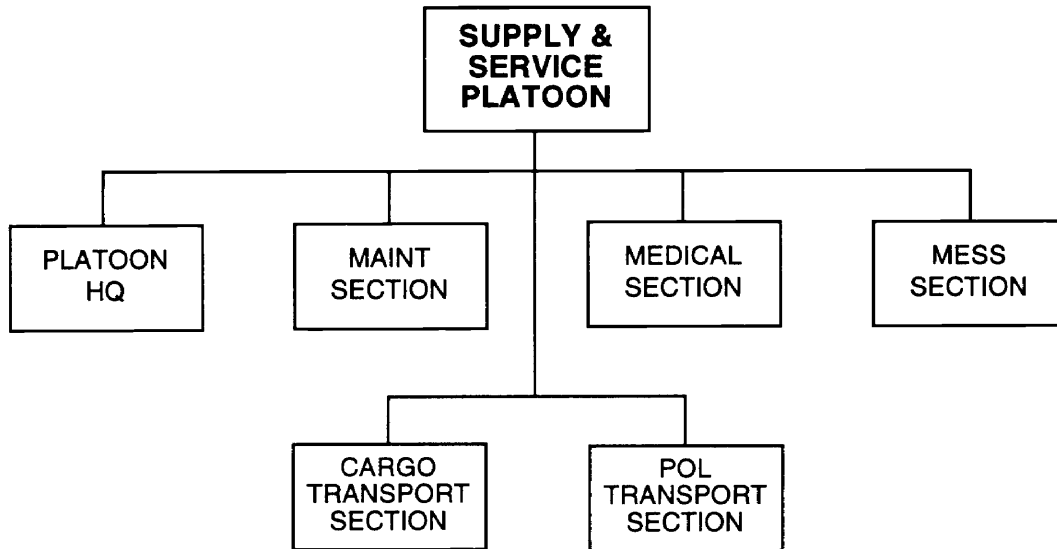

**PRINCIPAL ITEMS OF EQUIPMENT**

| <u>Equipment</u>                 | <u>Total</u> | <u>Equipment</u>                 | <u>Total</u> |
|----------------------------------|--------------|----------------------------------|--------------|
| Truck, Utility .....             | 1            | Trailer, Cargo, 2-Axle.....      | 4            |
| Truck, Medium .....              | 11           | Trailer, Generator.....          | 3            |
| Truck, Decon, DDA-53/66 .....    | 4            | Trailer, Kitchen.....            | 3            |
| Truck, POL (5,000-Liter).....    | 4            | Trailer, POL (4,200-Liter) ..... | 4            |
| Truck, Water (2,000-Liter) ..... | 1            | Trailer, Water (900-Liter) ..... | 1            |
| Van, Maintenance .....           | 2            | Radio, VHF, Manpack,             |              |
| Ambulance .....                  | 1            | Low-Power.....                   | 1            |

**Smoke Battalion,  
National**

---

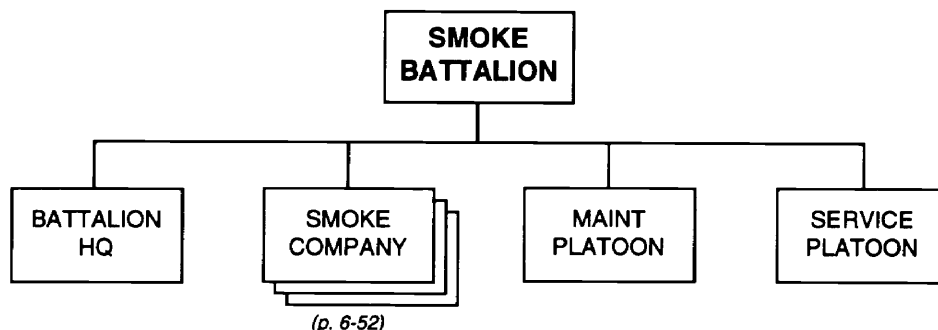

**PRINCIPAL ITEMS OF EQUIPMENT**

| <u>Equipment</u>                   | <u>Total</u> | <u>Equipment</u>                   | <u>Total</u> |
|------------------------------------|--------------|------------------------------------|--------------|
| Truck, Smoke Generator, TDA-M..... | 27           | Trailer, POL (4,200-Liter) .....   | 2            |
| Truck, Light .....                 | 5            | Trailer, Water (1,200-Liter) ..... | 4            |
| Truck, Medium .....                | 24           | Radios:                            |              |
| Truck, POL (5,000-Liter).....      | 2            | VHF, Manpack, Low-Power.....       | 3            |
| Van, Maintenance .....             | 5            | VHF, Vehicle Mount,                |              |
| Trailer, Cargo, 2-Axle.....        | 10           | Medium-Power .....                 | 29           |
| Trailer, Generator.....            | 3            | HF/VHF, Vehicle Mount,             |              |
| Trailer, Kitchen.....              | 3            | Medium-Power .....                 | 1            |

**Smoke Company,  
Smoke Bn**

---

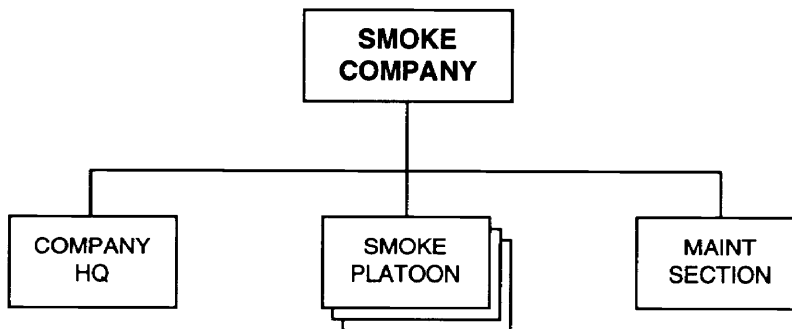

**PRINCIPAL ITEMS OF EQUIPMENT**

| <u>Equipment</u>                   | <u>Total</u> | <u>Equipment</u>                   | <u>Total</u> |
|------------------------------------|--------------|------------------------------------|--------------|
| Truck, Smoke Generator, TDA-M..... | 9            | Trailer, Kitchen.....              | 1            |
| Truck, Medium .....                | 4            | Trailer, Water (1,200-Liter) ..... | 1            |
| Van, Maintenance .....             | 1            | Radio, VHF, Vehicle Mount,         |              |
| Trailer, Cargo, 2-Axle.....        | 2            | Medium-Power .....                 | 9            |



## Logistics Troops, National

---

The Chief of Logistics in the General Staff/Ground Forces Headquarters controls several units and facilities. The numbers and types of these can vary widely, depending on the size and structure of the Ground Forces they support. The following organization chart represents the types of logistics units and facilities that may be available.

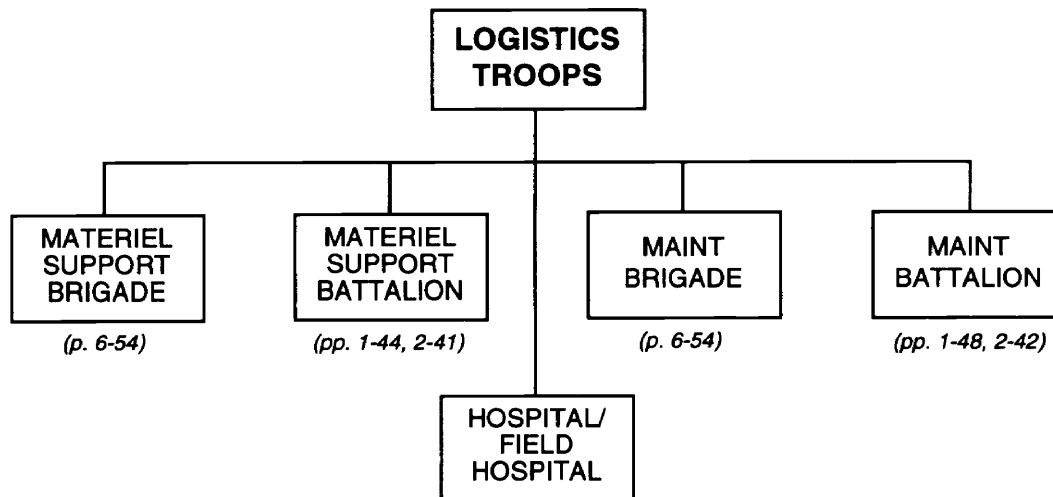

*NOTE:* The General Staff/Ground Forces Headquarters may allocate an entire materiel support or maintenance brigade to a military region or army. However, it may also allocate these assets as individual battalions.

**Materiel Support Brigade, MR  
or National**

---

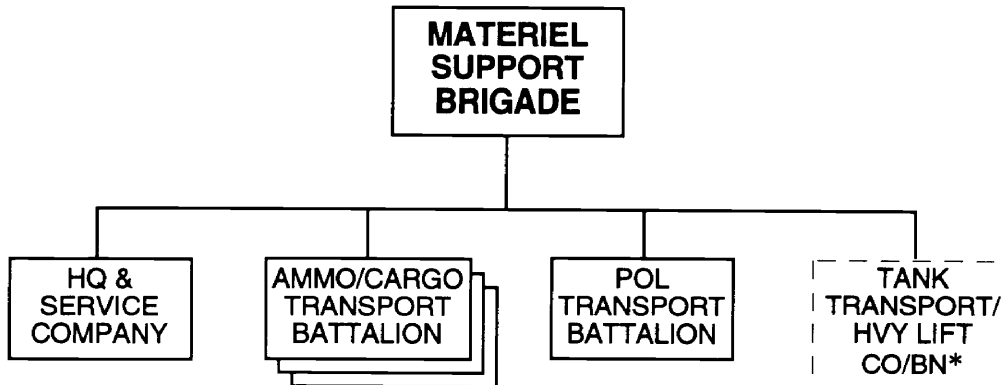

**NOTES:**

1. Materiel support brigades may have the structure shown above. The General Staff/Ground Forces Headquarters may retain such brigades at the national level, or allocate them to support a military region or an expeditionary army. This brigade structure facilitates centralized materiel support functions at the national or operational level.

2. Some materiel support brigades may consist of four or five materiel support battalions identical to those organic to divisions and districts (pp. 1-44 and 2-41). This configuration facilitates splitting the brigade's assets to support tactical units.

**FOOTNOTE:** \* When the mission dictates, a materiel support brigade may have a tank transport/heavy lift company or battalion. A company can move the armored vehicles of a mechanized infantry or tank battalion. An entire battalion can move the armored vehicles of a mechanized infantry or tank brigade.

**Maintenance Brigade, MR  
or National**

---

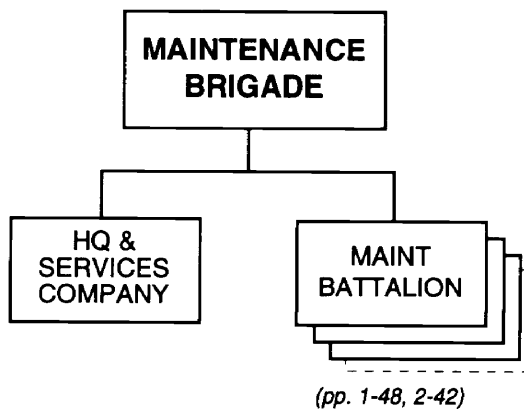

**NOTE:** Maintenance brigades have three or four maintenance battalions identical to those found in divisions and districts (pp. 1-48 and 2-42).

# Chapter 7

## National Military Structure

The OPFOR National Headquarters actually comprises three headquarters in one. It includes the Supreme High Command Headquarters and its executive agency, the General Staff. Since the Ground Forces are by far the largest branch of the armed forces, the National Headquarters also doubles as the Ground Forces Headquarters. Of the four branches, only the Ground Forces and the Air Force are large enough to warrant separate chapters. (Chapters 1 through 5 cover the Ground Forces, and Chapter 8 the Air Force.) This chapter provides some detail on the other two branches: the Special Operations Command and the Navy. It also covers the General Staffs Directorate of Military Intelligence and the Internal Security Forces of the Ministry of the Interior, which come under control of the General Staff in wartime.

### CONTENTS

|  |      |
|--|------|
| <b>National Headquarters</b> .....                               | 7-2  |
| <b>Special Operations Command</b> .....                          | 7-3  |
| Special-Purpose Forces Brigade, SOC .....                        | 7-3  |
| Special-Purpose Forces Battalion, SPF Bde .....                  | 7-4  |
| Special-Purpose Forces Team, SPF Co .....                        | 7-5  |
| Commando Battalion, SOC or MD or CDF .....                       | 7-6  |
| Battalion Headquarters, Commando Bn .....                        | 7-8  |
| Commando Company, Commando Bn.....                               | 7-8  |
| Commando Platoon, Commando Co .....                              | 7-9  |
| Commando Squad, Commando Plt.....                                | 7-10 |
| Mortar Platoon, Commando Bn or Arty Btry, Commando Bn .....      | 7-11 |
| Artillery Battery, Commando Bn.....                              | 7-12 |
| Rocket Launcher Platoon, Arty Btry, Commando Bn .....            | 7-13 |
| Weapons Company, Commando Bn.....                                | 7-14 |
| Heavy Machinegun Platoon, Wpns Co, Commando Bn.....              | 7-15 |
| Antitank Platoon, Wpns Co, Commando Bn.....                      | 7-16 |
| Engineer Platoon, Commando Bn .....                              | 7-17 |
| Signal Platoon, Commando Bn.....                                 | 7-18 |
| Supply and Service Platoon, Commando Bn.....                     | 7-19 |
| Troop Transport Platoon, Commando Bn.....                        | 7-20 |
| <b>Navy</b> .....  | 7-21 |
| <b>Directorate of Military Intelligence, General Staff</b> ..... | 7-22 |
| Signals Reconnaissance Battalion, DMI.....                       | 7-23 |
| Reconnaissance and Electronic Combat Battalion, DMI .....        | 7-24 |
| <b>Internal Security Forces</b> .....                            | 7-25 |

National Headquarters

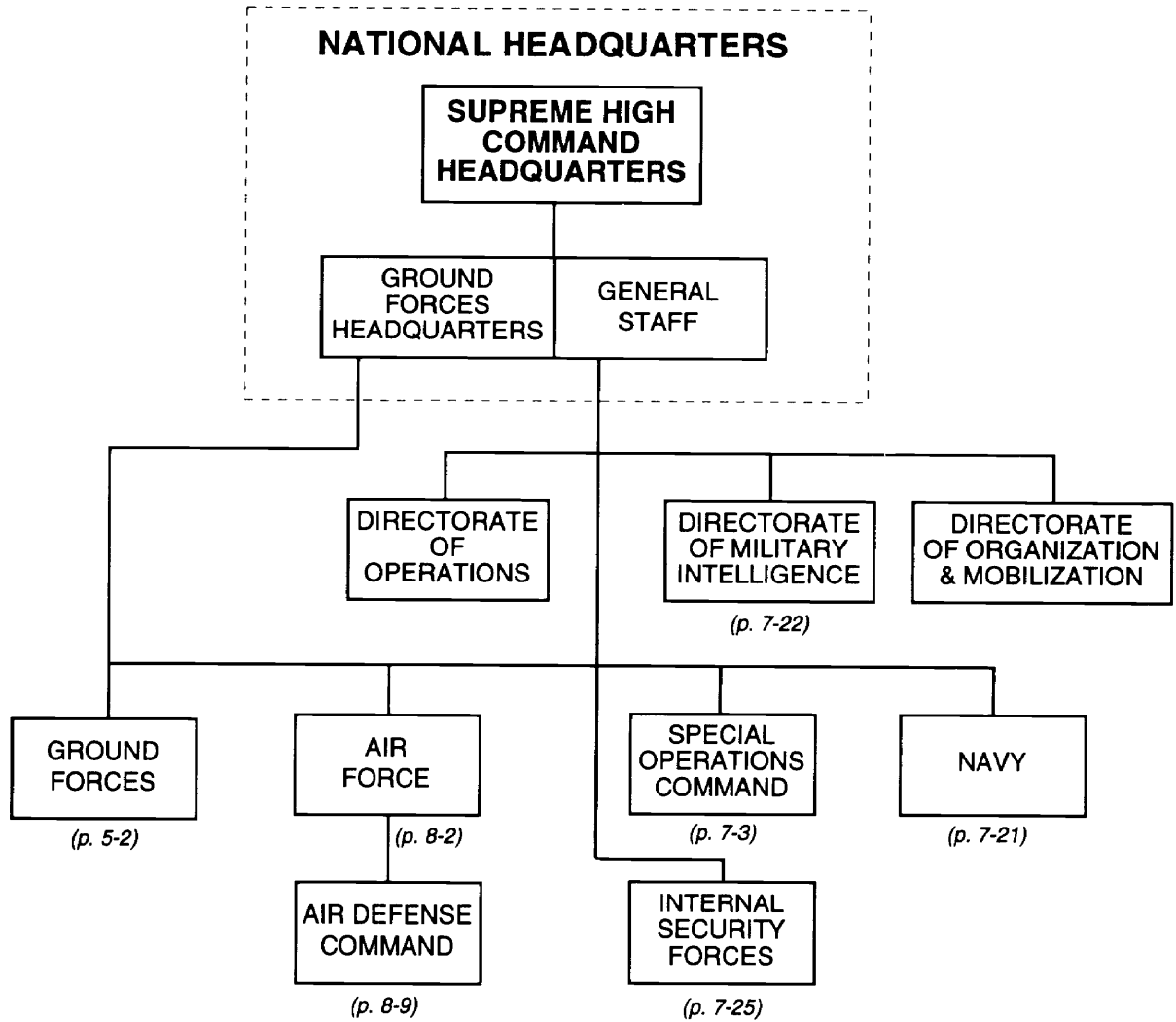

NOTES:

1. The OPFOR National Headquarters also serves as Ground Forces Headquarters. Since the Ground Forces comprise by far the largest branch of the armed forces, its officers dominate the National Headquarters. The President of the State Government holds the title of Supreme High Commander of Forces. However, the primary military authority in the Supreme High Command Headquarters is the Commander of the Armed Forces. He is the most senior Ground Forces general officer and also serves in the President's cabinet as Minister of Defense.

2. The General Staff is the executive agency for the Supreme High Command. A first deputy minister of defense, also a Ground Forces general, is the Chairman of the General Staff. The General Staff consists predominantly of Ground Forces personnel, many of whom also hold positions in the Ground Forces Headquarters. Representatives of other branches primarily advise on how those branches can provide support to the Ground Forces. The General Staff controls all branches of the armed forces, as well as national-level intelligence assets and internal security forces.

**Special Operations Command**

---

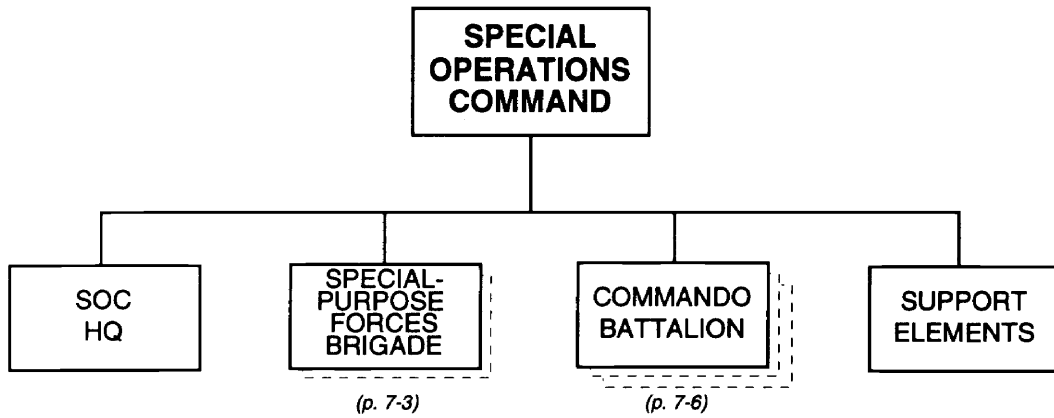

*NOTE:* There is no fixed number of special-purpose forces (SPF) brigades and commando battalions. Normally, the command has one SPF brigade. The number of commando battalions located at the national level depends on how many have been subordinated to military districts.

**Special-Purpose Forces Brigade, SOC**

---

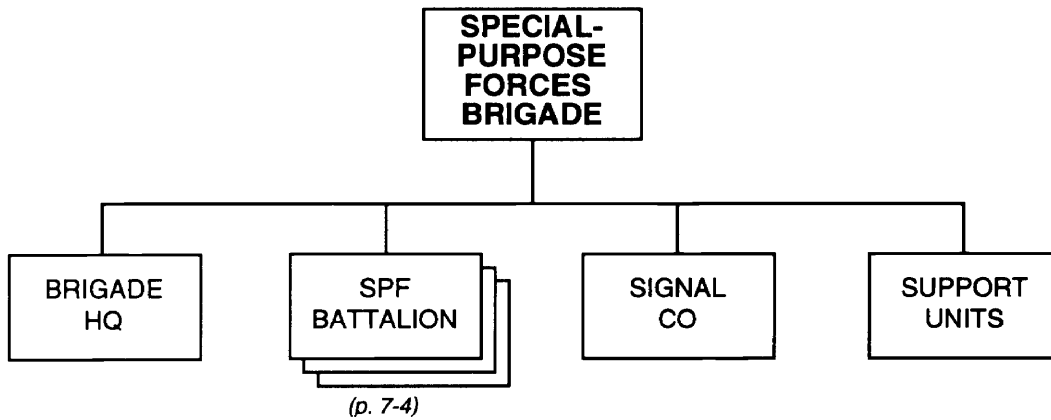

**NOTES:**

1. The brigade structure is not fixed. This chart represents what may be the organization of a typical brigade.
2. A brigade may deploy about 27 to 45 SPF teams.

**Special-Purpose Forces Battalion,  
SPF Bde**

---

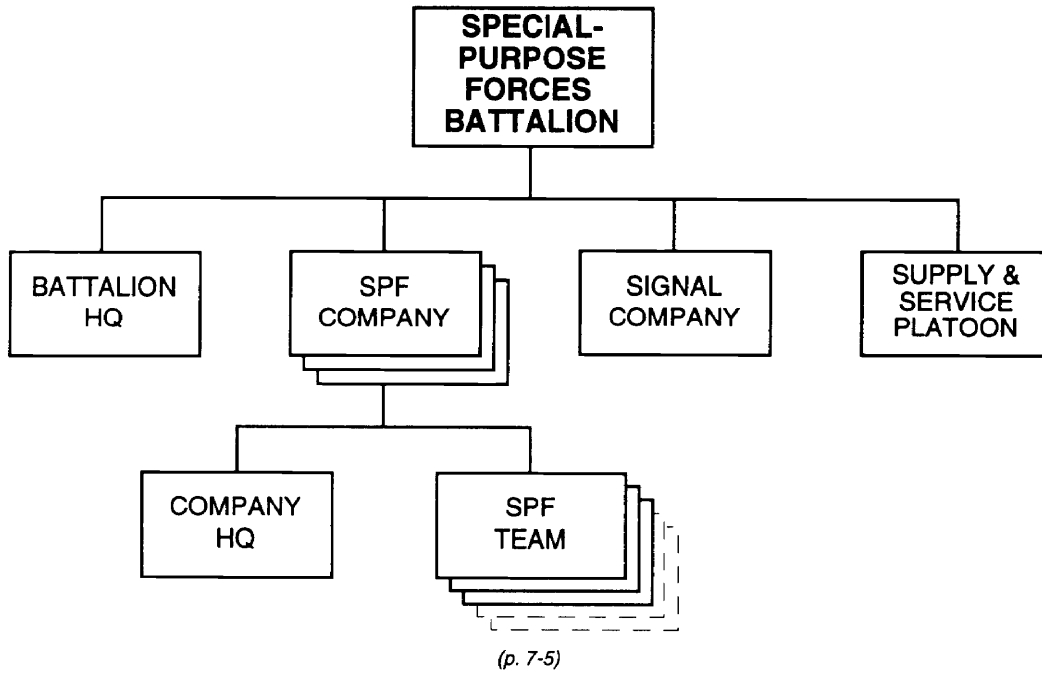

**NOTES:**

1. The battalion structure is not fixed.
2. The total number of teams an SPF battalion can deploy varies from 9 to 15.

**Special-Purpose Forces Team,  
SPF Co**

---



Team Leader (Officer)..... AKS-74 or AKSU-74, PM  
 Asst Team Leader (WO or Senior NCO) ..... AKS-74 or AKSU-74, PM  
 1-2x Communications Specialist..... Radio, AKS-74 or AKSU-74, PM  
 1-2x Weapons Specialist ..... RPG-16D, PM  
 1-2x Demolitions Specialist..... AKS-74 or AKSU-74, PM  
 0-4x Recon Specialist ..... AKS-74 or AKSU-74, PM

**PRINCIPAL ITEMS OF EQUIPMENT**

| <u>Equipment</u>  | <u>Total</u> | <u>Equipment</u>                                   | <u>Total</u> |
|---|--------------|--|--------------|
| 9-mm Pistol, PM.....  | 5-12         | 40-mm Under-Barrel Grenade Launcher,<br>BG-15..... | 2-5          |
| 5.45-mm Assault Rifle, AKS-74 or<br>5.45-mm Submachinegun,<br>AKSU-74 ..... | 4-10         | ATGL, RPG-16D.....                                 | 1-2          |
| 7.62-mm Sniper Rifle, SVD .....   | 1            | Night-Vision Goggles .....                         | 1            |
|   |              | Night-Vision Sight (Small Arms).....               | 2-5          |
|   |              | Radio, Burst-Transmission .....                    | 1-2          |

**NOTES:**

1. Team composition is not fixed. The organization above shows the variations that may exist within what may be a typical SPF team.
2. In keeping with its behind-the-lines missions, the SPF team is lightly equipped. Each soldier normally has an assault rifle, a silenced pistol, a knife, and up to eight hand grenades of various types. In addition, the team's equipment normally includes an SVD sniper rifle, directional mines, explosives, and night-vision devices. The team can also receive shoulder-fired SAMs, manpack ATGMs, or RPO flamethrowers. Equipment may vary with the mission.
3. At least one team member has received training as a medic.

Commando Battalion,  
SOC or MD or CDF

---

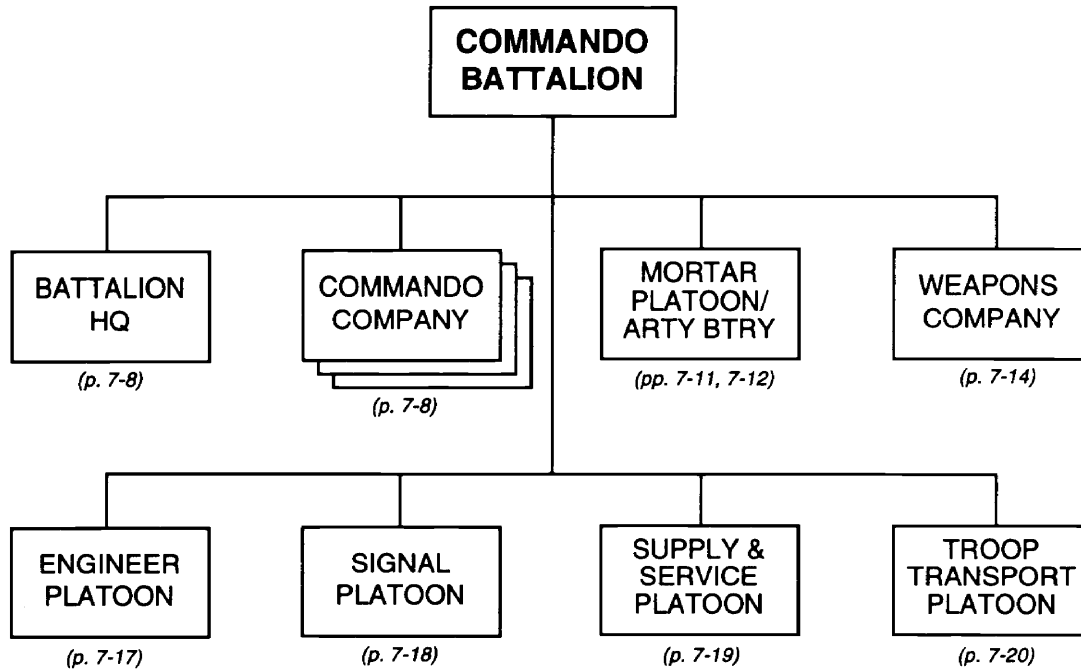

**NOTES:**

1. Commando battalions are organic to the Special Operations Command and the better-equipped districts, including the Capital Defense Forces. These battalions have special training in counterinsurgency. Their role in conventional operations is to provide special reconnaissance and direct action behind enemy lines.
2. Some commando battalions may have an entire artillery battery (p. 7-12) rather than the single mortar platoon (p. 7-11 ) reflected in the equipment totals above.

**(continued)**



**Commando Battalion,  
SOC or MD or CDF (continued)**

| <i>Principal Items of Equipment</i> | <i>Battalion HQ</i> | <i>Commando Co (3x)</i> | <i>Weapons Co</i> | <i>Mortar Plt</i> | <i>Engineer Plt</i> | <i>Signal Plt</i> | <i>Supply &amp; Service Plt</i> | <i>Troop Transport Co</i> | <i>TOTAL</i> |
|-------------------------------------|---------------------|-------------------------|-------------------|-------------------|---------------------|-------------------|---------------------------------|---------------------------|--------------|
| <b>WEAPONS</b>                      |                     |                         |                   |                   |                     |                   |                                 |                           |              |
| 9-mm Pistol, PM                     | 4                   | 114                     | 22                | 4                 | 1                   | 1                 | 1                               | 1                         | 148          |
| 5.45-mm Assault Rifle, AK-74        | 10                  | 282                     | 69                | 18                | 10                  | 19                | 20                              | 55                        | 483          |
| 5.45-mm LMG, RPK-74                 |                     |                         |                   |                   | 2                   |                   |                                 |                           | 2            |
| 7.62-mm GP MG, PKM                  |                     | 54                      |                   |                   | 2                   |                   |                                 |                           | 56           |
| 7.62-mm Sniper Rifle, SVD           |                     | 27                      |                   |                   |                     |                   |                                 |                           | 27           |
| 12.7-mm Heavy MG, DShK or NSV       |                     |                         | 4                 |                   |                     |                   |                                 |                           | 4            |
| 40-mm Under-Barrel Gren Lchr, BG-15 | 2                   | 60                      | 9                 | 4                 |                     | 1                 |                                 | 3                         | 79           |
| 30-mm Auto Grenade Lchr, AGS-17     |                     |                         | 6                 |                   |                     |                   |                                 |                           | 6            |
| 60-mm Mortar, Light                 |                     | 9                       |                   |                   |                     |                   |                                 |                           | 9            |
| 82-mm Mortar, M1937/2B9             |                     |                         |                   | 3                 |                     |                   |                                 |                           | 3            |
| SAM, Shoulder-Fired                 |                     |                         | 9                 |                   |                     |                   |                                 |                           | 9            |
| ATGM Manpack, AT-7/SAXHORN          |                     |                         | 3                 |                   |                     |                   |                                 |                           | 3            |
| 73-mm Recoilless Gun, SPG-9         |                     |                         | 2                 |                   |                     |                   |                                 |                           | 2            |
| ATGL, RPG-7V                        |                     | 54                      | 3                 |                   |                     |                   |                                 |                           | 57           |
| ATRL, RPG-18/22                     | 2                   | 120                     | 7                 | 3                 | 3                   |                   | 1                               | 3                         | 139          |
| Flamethrower, LPO/RPO               |                     | 9                       |                   |                   | 2                   |                   |                                 |                           | 11           |
| <b>TRUCKS</b>                       |                     |                         |                   |                   |                     |                   |                                 |                           |              |
| Truck, Utility                      | 1                   |                         | 1                 |                   | 1                   | 1                 | 1                               |                           | 5            |
| Truck, Light                        | 3                   |                         | 11                | 4                 | 4                   | 1                 | 10                              | 24                        | 57           |
| Truck, POL (4,000-L)                |                     |                         |                   |                   |                     |                   | 2                               | 1                         | 3            |
| Van, Maintenance                    |                     |                         |                   |                   |                     |                   | 1                               | 1                         | 2            |
| Van, Signal                         |                     |                         |                   |                   |                     | 1                 |                                 |                           | 1            |
| Ambulance                           |                     |                         |                   |                   |                     |                   | 1                               |                           | 1            |
| <b>TRAILERS</b>                     |                     |                         |                   |                   |                     |                   |                                 |                           |              |
| Trailer, Cargo, 1-Axle              |                     |                         |                   |                   | 4                   |                   | 5                               | 5                         | 14           |
| Trailer, Generator                  |                     |                         |                   |                   |                     |                   | 1                               |                           | 1            |
| Trailer, Kitchen                    |                     |                         |                   |                   |                     |                   | 3                               |                           | 3            |
| Trailer, POL (1,200-L)              |                     |                         |                   |                   |                     |                   | 2                               | 1                         | 3            |
| Trailer, Water (900-L)              |                     |                         |                   |                   |                     |                   | 3                               | 2                         | 5            |
| <b>RADIOS</b>                       |                     |                         |                   |                   |                     |                   |                                 |                           |              |
| VHF, Manpack, Low-Power             | 2                   |                         | 9                 | 4                 | 2                   | 3                 | 4                               |                           | 24           |
| VHF, Portable, Low-Power            | 2                   | 54                      | 3                 |                   | 1                   | 1                 |                                 | 2                         | 63           |
| VHF, Portable, Very-Low-Power       |                     |                         | 4                 |                   |                     |                   |                                 |                           | 4            |
| VHF, Vehicle Mount, Medium-Power    | 1                   |                         |                   |                   |                     | 1                 |                                 |                           | 2            |
| HF, Vehicle Mount, Medium-Power     | 1                   |                         |                   |                   |                     | 1                 |                                 |                           | 2            |
| HF/VHF, Vehicle Mount, Med-Power    |                     |                         |                   |                   |                     | 1                 |                                 |                           | 1            |
| Burst Transmission Radio            | 1                   | 3                       |                   |                   |                     | 1                 |                                 |                           | 5            |
| Warning Receiver                    | 1                   |                         |                   |                   |                     | 1                 |                                 |                           | 2            |
| <b>MISCELLANEOUS</b>                |                     |                         |                   |                   |                     |                   |                                 |                           |              |
| Rangefinder, Steroscopic            |                     |                         |                   | 1                 |                     |                   |                                 |                           | 1            |
| Periscopic Aiming Circle            |                     |                         |                   | 1                 |                     |                   |                                 |                           | 1            |
| Collimator                          |                     |                         |                   | 3                 |                     |                   |                                 |                           | 3            |
| Demolition Set                      |                     |                         |                   |                   | 2                   |                   |                                 |                           | 2            |
| Motorcycle                          |                     |                         |                   |                   |                     | 3                 |                                 |                           | 3            |
| Night-Vision Goggles                | 2                   | 54                      |                   |                   | 1                   | 2                 |                                 |                           | 59           |
| Night-Vision Goggles (Driver)       | 1                   |                         | 11                | 4                 | 3                   | 3                 | 3                               | 3                         | 28           |
| Night-Vision Sight (Small Arms)     | 2                   | 63                      | 9                 | 4                 | 3                   | 2                 |                                 | 5                         | 88           |
| Night-Vision Sight (MG)             |                     | 54                      | 4                 |                   | 2                   |                   |                                 |                           | 60           |

**Battalion Headquarters, Commando Bn** \_\_\_\_\_



**PRINCIPAL ITEMS OF EQUIPMENT**

| <u>Equipment</u>                                   | <u>Total</u> | <u>Equipment</u>                         | <u>Total</u> |
|--|--------------|--|--------------|
| 9-mm Pistol, PM.....                               | 4            | <b>Radios:</b>                           |              |
| 5.45-mm Assault Rifle, AK-74.....                  | 10           | VHF, Manpack, Low-Power.....             | 2            |
| 40-mm Under-Barrel Grenade Launcher,<br>BG-15..... | 2            | VHF, Portable, Low-Power.....            | 2            |
| ATRL, RPG-18/22.....                               | 2            | VHF, Vehicle Mount,<br>Medium-Power..... | 1            |
| Truck, Utility.....                                | 1            | HF, Vehicle Mount,<br>Medium-Power.....  | 1            |
| Truck, Light.....                                  | 3            | Burst Transmission Radio.....            | 1            |
| Night-Vision Goggles.....                          | 2            | Warning Receiver.....                    | 1            |
| Night-Vision Goggles (Driver).....                 | 1            |  |              |
| Night-Vision Sight (Small Arms).....               | 2            |  |              |

**Commando Company, Commando Bn** \_\_\_\_\_

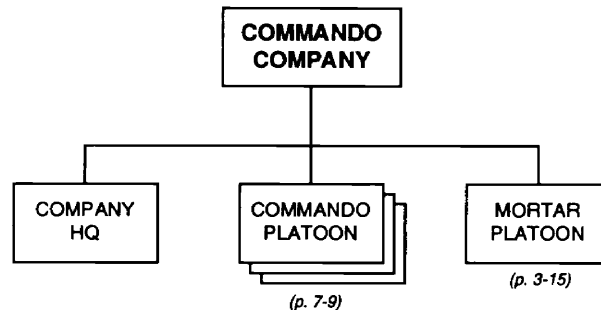

Company Commander .....PM  
 Deputy Company Cdr .....PM  
 First Sergeant.....AK-74

**PRINCIPAL ITEMS OF EQUIPMENT**

| <u>Equipment</u>                                   | <u>Total</u> | <u>Equipment</u>                     | <u>Total</u> |
|--|--------------|--------------------------------------|--------------|
| 9-mm Pistol, PM.....                               | 38           | ATGL, RPG-7V.....                    | 18           |
| 5.45-mm Assault Rifle, AK-74.....                  | 94           | Flamethrower, LPO/RPO.....           | 3            |
| 7.62-mm GP MG, PKM.....                            | 18           | Night-Vision Goggles.....            | 18           |
| 7.62-mm Sniper Rifle, SVD.....                     | 9            | Night-Vision Sight (Small Arms)..... | 21           |
| 40-mm Under-Barrel Grenade Launcher,<br>BG-15..... | 20           | Night-Vision Sight (MG).....         | 18           |
| 60-mm Mortar, Light.....                           | 3            | <b>Radios:</b>                       |              |
| ATRL, RPG-18/22.....                               | 40           | VHF, Portable, Low-Power.....        | 18           |
|  |              | Burst Transmission Radio.....        | 1            |

Commando Platoon,  
Commando Co

---

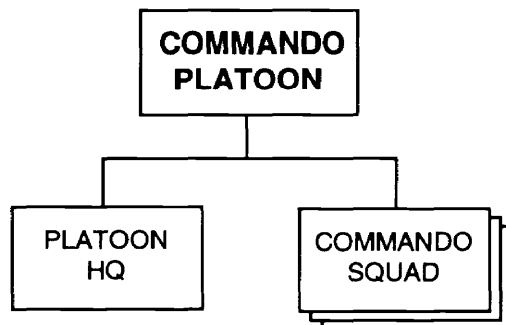

(p. 7-10)

Platoon Leader ..... AK-74  
Asst Plt Leader ..... AK-74

**PRINCIPAL ITEMS OF EQUIPMENT**

| <u>Equipment</u>                                   | <u>Total</u> |
|--|--------------|
| 9-mm Pistol, PM.....                               | 12           |
| 5.45-mm Assault Rifle, AK-74.....                  | 26           |
| 7.62-mm GP MG, PKM.....                            | 6            |
| 7.62-mm Sniper Rifle, SVD .....                    | 3            |
| 40-mm Under-Barrel Grenade Launcher,<br>BG-15..... | 6            |
| ATRL, RPG-18/22.....                               | 12           |

| <u>Equipment</u>                     | <u>Total</u> |
|--------------------------------------|--------------|
| ATGL, RPG-7V.....                    | 6            |
| Flamethrower, LPO/RPO.....           | 1            |
| Night-Vision Goggles .....           | 4            |
| Night-Vision Sight (Small Arms)..... | 6            |
| Night-Vision Sight (MG).....         | 6            |
| Radio, VHF, Portable, Low-Power..... | 4            |

Commando Squad,  
Commando Plt \_\_\_\_\_

|                           |
|---------------------------|
| <b>COMMANDO<br/>SQUAD</b> |
|---------------------------|

Squad Leader .....AK-74  
 Senior Rifleman (x2) ..... BG-15, AK-74  
 Grenadier (x2) ..... RPG-7V, PM  
 Machinegunner (x2) ..... PKM, PM  
 Rifleman (x5).....AK-74

**PRINCIPAL ITEMS OF EQUIPMENT**

| <u>Equipment</u>                                   | <u>Total</u> | <u>Equipment</u>                     | <u>Total</u> |
|--|--------------|--------------------------------------|--------------|
| 9-mm Pistol, PM.....                               | 4            | ATRL, RPG-18/22.....                 | 4            |
| 5.45-mm Assault Rifle, AK-74.....                  | 8            | ATGL, RPG-7V.....                    | 2            |
| 7.62-mm GP MG, PKM.....                            | 2            | Night-Vision Goggles.....            | 1            |
| 7.62-mm Sniper Rifle, SVD.....                     | 1            | Night-Vision Sight (Small Arms)..... | 2            |
| 40-mm Under-Barrel Grenade Launcher,<br>BG-15..... | 2            | Night-Vision Sight (MG).....         | 2            |
|  |              | Radio, VHF, Portable, Low-Power..... | 1            |

**NOTES:**

1. Each commando squad has a sniper rifle. All riflemen are capable of using it.
2. Normally, one squad per platoon has a flamethrower, LPO/RPO. In some cases, however, there may be one flamethrower per squad.

**Mortar Platoon, Commando Bn or Arty Btry,  
Commando Bn**

---

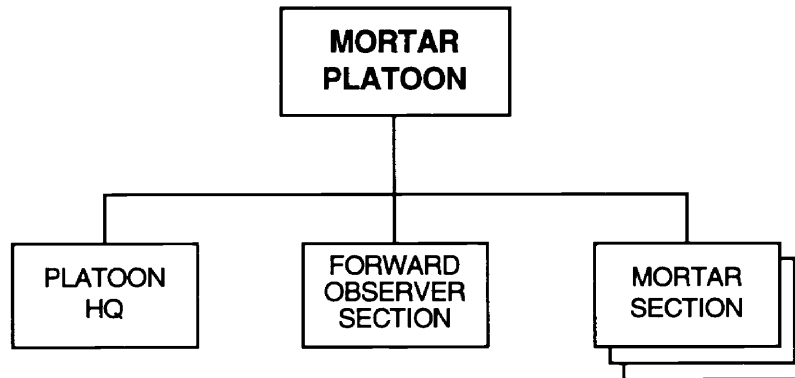

**PRINCIPAL ITEMS OF EQUIPMENT**

| <u>Equipment</u>                                   | <u>Total</u> | <u>Equipment</u>                      | <u>Total</u> |
|--|--------------|---------------------------------------|--------------|
| 82-mm Mortar, M1937/2B9 .....                      | 3            | Truck, Light .....                    | 4            |
| 9-mm Pistol, PM.....                               | 4            | Night-Vision Goggles (Driver) .....   | 4            |
| 5.45-mm Assault Rifle, AK-74.....                  | 18           | Night-Vision Sight (Small Arms).....  | 4            |
| 7.62-mm GP MG, PKM.....                            | 1            | Rangefinder, Stereoscopic, DS-1 ..... | 1*           |
| 40-mm Under-Barrel Grenade Launcher,<br>BG-15..... | 4            | Periscopic Aiming Circle, PAB2A.....  | 1*           |
| ATRL, RPG-18/22.....                               | 3            | Collimator .....                      | 3            |
|  |              | Radio, VHF, Manpack, Low-Power .....  | 4            |

**FOOTNOTE:** \* When the mortar is part of an artillery battery, the stereoscopic rangefinder and periscopic aiming circle are in the battery headquarters rather than in the mortar platoon.

Artillery Battery,  
Commando Bn

---

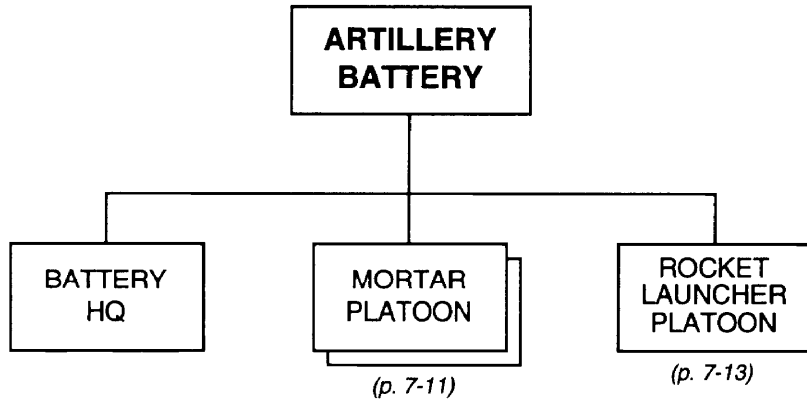

**PRINCIPAL ITEMS OF EQUIPMENT**

| <u>Equipment</u>                                     | <u>Total</u> |
|--|--------------|
| 82-mm Mortar, M1937/2B9 .....                        | 6            |
| 122-mm Single-Tube Rocket Launcher,<br>BM-21-P ..... | 6            |
| 9-mm Pistol, PM.....                                 | 10           |
| 5.45-mm Assault Rifle, AKS-74 .....                  | 59           |
| 7.62-mm GP MG, PKM.....                              | 3            |
| 40-mm Under-Barrel Grenade Launcher,<br>BG-15.....   | 13           |
| ATRL, RPG-18/22.....                                 | 9            |
| Truck, Utility .....                                 | 1            |
| Truck, Light .....                                   | 12           |
| Night-Vision Goggles, (Driver).....                  | 13           |

| <u>Equipment</u>   | <u>Total</u> |
|--|--------------|
| Night-Vision Sight (Small Arms).....   | 13           |
| Rangefinder, Stereoscopic, DS-1.....   | 1            |
| Periscopic Aiming Circle, PAB2A .....  | 1            |
| Collimator .....   | 6            |
| Radar, Battlefield Surveillance, Man-<br>Portable, PSNR-1 or TALL MIKE ..... | 1            |
| Radios:  |              |
| VHF Manpack, Low-Power.....  | 12           |
| VHF, Portable, Low-Power .....   | 2            |
| VHF, Vehicle-Mount,<br>Medium-Power .....                                    | 1            |
| Warning Receiver .....   | 1            |

**Rocket Launcher Platoon,  
Arty Btry, Commando Bn**

---

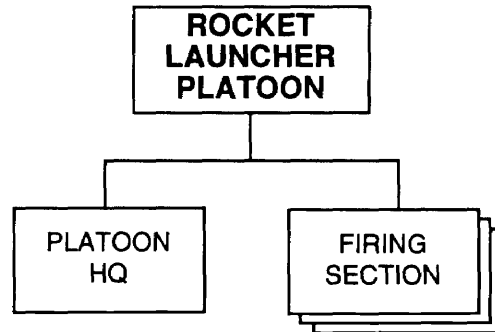

**PRINCIPAL ITEMS OF EQUIPMENT**

| <u>Equipment</u>                                     | <u>Total</u> |
|--|--------------|
| 122-mm Single-Tube Rocket Launcher,<br>BM-21-P ..... | 6            |
| 9-mm Pistol, PM.....                                 | 1            |
| 5.45-mm Assault Rifle, AKS-74 .....                  | 18           |
| 7.62-mm GP MG, PKM.....                              | 1            |
| 40-mm Under-Barrel Grenade Launcher,<br>BG-15.....   | 4            |

| <u>Equipment</u>                     | <u>Total</u> |
|--------------------------------------|--------------|
| ATRL, RPG-18/22.....                 | 3            |
| Truck, Light .....                   | 4            |
| Night-Vision Goggles (Driver) .....  | 4            |
| Night-Vision Sight (Small Arms)..... | 4            |
| Radio, VHF Manpack, Low-Power .....  | 4            |

**Weapons Company,  
Commando Bn**

---

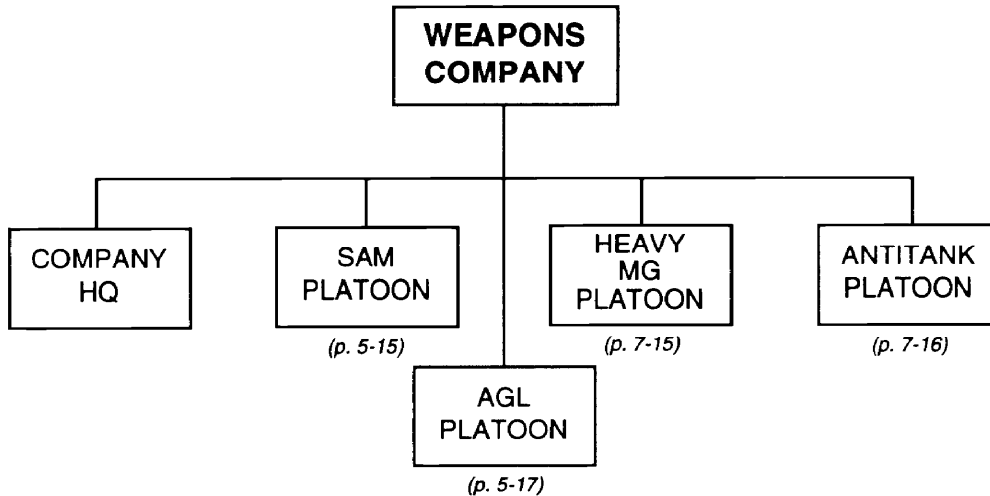

**PRINCIPAL ITEMS OF EQUIPMENT**

| <u>Equipment</u>                                   | <u>Total</u> | <u>Equipment</u>                     | <u>Total</u> |
|--|--------------|--------------------------------------|--------------|
| 9-mm Pistol, PM.....                               | 22           | ATGL, RPG-7V.....                    | 3            |
| 5.45-mm Assault Rifle, AK-74.....                  | 69           | ATRL, RPG-18/22.....                 | 7            |
| 12.7-mm Heavy Machinegun,<br>DShK or NSV.....      | 4            | Truck, Utility.....                  | 1            |
| 30-mm Automatic Grenade Launcher,<br>AGS-17.....   | 6            | Truck, Light.....                    | 11           |
| 40-mm Under-Barrel Grenade Launcher,<br>BG-15..... | 9            | Night-Vision Goggles (Driver).....   | 11           |
| SAM, Shoulder-Fired.....                           | 9            | Night-Vision Sight (Small Arms)..... | 9            |
| ATGM Manpack, AT-7/SAXHORN.....                    | 3            | Night-Vision Sight (MG).....         | 4            |
| 73-mm Recoilless Gun, SPG-9.....                   | 2            | Radios:                              |              |
|  |              | VHF, Manpack, Low-Power.....         | 9            |
|  |              | VHF, Portable, Low-Power.....        | 3            |
|  |              | VHF, Portable, Very-Low-Power.....   | 4            |

*NOTE:* The battalion commander may retain the shoulder-fired SAM and automatic grenade launcher platoons under his own control. Alternatively, he may allocate their squads to support individual commando companies or other platoons in the weapons company.



**Heavy Machinegun Platoon,  
Wpns Co, Commando Bn**

---

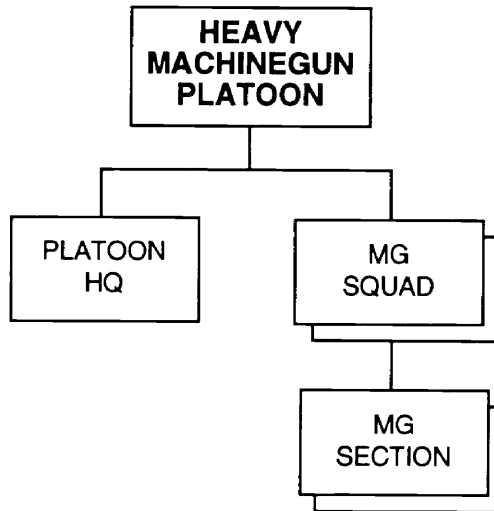

**PRINCIPAL ITEMS OF EQUIPMENT**

| <u>Equipment</u>                                   | <u>Total</u> |
|--|--------------|
| 12.7-mm Heavy MG, DShK or NSV.....                 | 4            |
| ATRL, RPG-18/22.....                               | 2            |
| ATGL, RPG-7V.....                                  | 3            |
| 9-mm Pistol, PM.....                               | 4            |
| 5.45-mm Assault Rifle, AK-74.....                  | 15           |
| 40-mm Under-Barrel Grenade Launcher,<br>BG-15..... | 5            |

| <u>Equipment</u>                     | <u>Total</u> |
|--------------------------------------|--------------|
| Truck, Light .....                   | 3            |
| Night-Vision Goggles (Driver).....   | 3            |
| Night-Vision Sight (Small Arms)..... | 3            |
| Night-Vision Sight (MG).....         | 4            |
| Radio, VHF, Portable, Low-Power..... | 3            |

Antitank Platoon,  
Wpns Co, Commando Bn

---

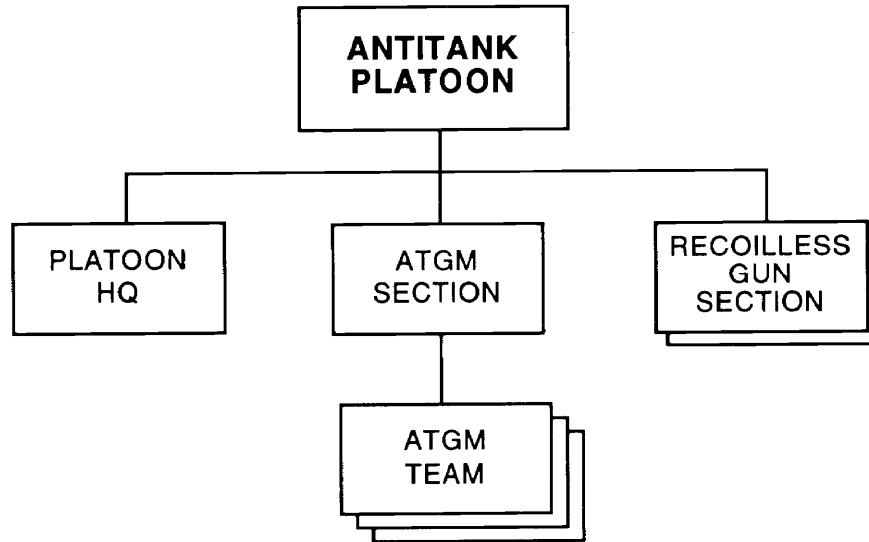

**PRINCIPAL ITEMS OF EQUIPMENT**

| <u>Equipment</u>                                   | <u>Total</u> |
|--|--------------|
| ATGM Manpack, AT-7/SAXHORN.....                    | 3            |
| 73-mm Recoilless Gun, SPG-9.....                   | 2            |
| 9-mm Pistol, PM.....                               | 4            |
| 5.45-mm Assault Rifle, AK-74.....                  | 17           |
| 40-mm Under-Barrel Grenade Launcher,<br>BG-15..... | 4            |

| <u>Equipment</u>                     | <u>Total</u> |
|--------------------------------------|--------------|
| ATRL, RPG-18/22.....                 | 2            |
| Truck, Light.....                    | 2            |
| Night-Vision Goggles (Driver).....   | 2            |
| Night-Vision Sight (Small Arms)..... | 5            |
| Radio, VHF, Manpack, Low-Power.....  | 4            |

**Engineer Platoon,  
Commando Bn**

---

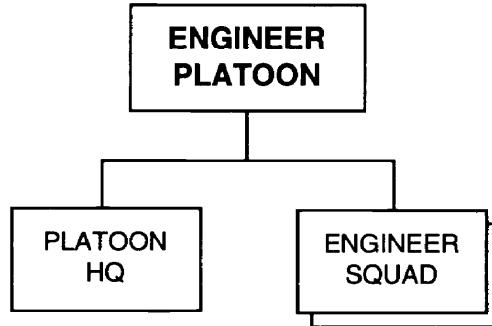

**PRINCIPAL ITEMS OF EQUIPMENT**

| <u>Equipment</u>                    | <u>Total</u> |
|-------------------------------------|--------------|
| 9-mm Pistol, PM.....                | 1            |
| 5.45-mm Assault Rifle, AKS-74 ..... | 10           |
| 5.45-mm LMG, RPKS-74.....           | 2            |
| 7.62-mm GP MG, PKM.....             | 2            |
| ATRL, RPG-18/22.....                | 3            |
| Flamethrower, LPO/RPO.....          | 2            |
| Truck, Utility .....                | 1            |
| Truck, Light .....                  | 4            |

| <u>Equipment</u>                     | <u>Total</u> |
|--------------------------------------|--------------|
| Trailer, 1-Axle .....                | 4            |
| Demolition Set.....                  | 2            |
| Night-Vision Goggles,.....           | 1            |
| Night-Vision Goggles, (Driver).....  | 3            |
| Night-Vision Sight (Small Arms)..... | 3            |
| Night-Vision Sight (MG).....         | 2            |
| Radio, VHF, Manpack, Low-Power ..... | 4            |

Signal Platoon,  
Commando Bn

---

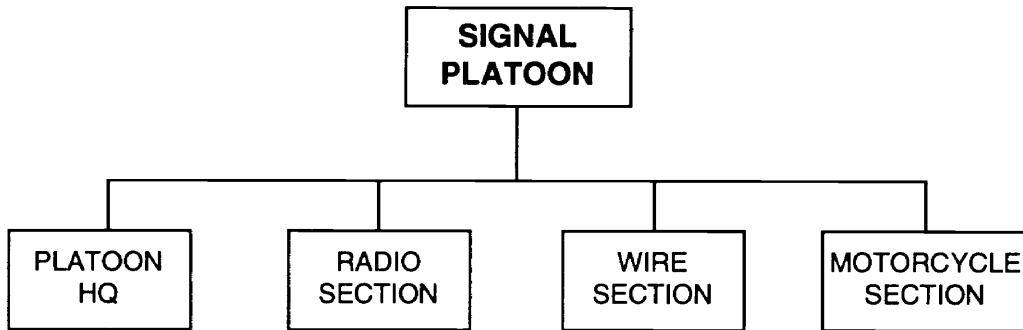

(p. 3-32)

**PRINCIPAL ITEMS OF EQUIPMENT**

| <u>Equipment</u>                                   | <u>Total</u> | <u>Equipment</u>                             | <u>Total</u> |
|--|--------------|--|--------------|
| 9-mm Pistol, PM.....                               | 1            | Radios:                                      |              |
| 5.45-mm Assault Rifle, AK-74.....                  | 19           | VHF, Manpack, Low-Power.....                 | 3            |
| 40-mm Under-Barrel Grenade Launcher,<br>BG-15..... | 1            | VHF, Portable, Low-Power .....               | 1            |
| Truck, Utility .....                               | 1            | VHF, Vehicle Mount,<br>Medium-Power .....    | 1            |
| Truck, Light .....                                 | 1            | HF, Vehicle Mount,<br>Medium-Power .....     | 1            |
| Van, Signal.....                                   | 1            | HF/VHF, Vehicle Mount,<br>Medium-Power ..... | 1            |
| Motorcycle .....                                   | 3            | Burst Transmission .....                     | 1            |
| Night-Vision Goggles .....                         | 2            | Warning Receiver .....                       | 1            |
| Night-Vision Goggles (Driver).....                 | 3            |  |              |
| Night-Vision Sight (Small Arms).....               | 2            |  |              |

*NOTE:* The motorcycle section provides courier service for the battalion commander.

**Supply and Service Platoon,  
Commando Bn**

---

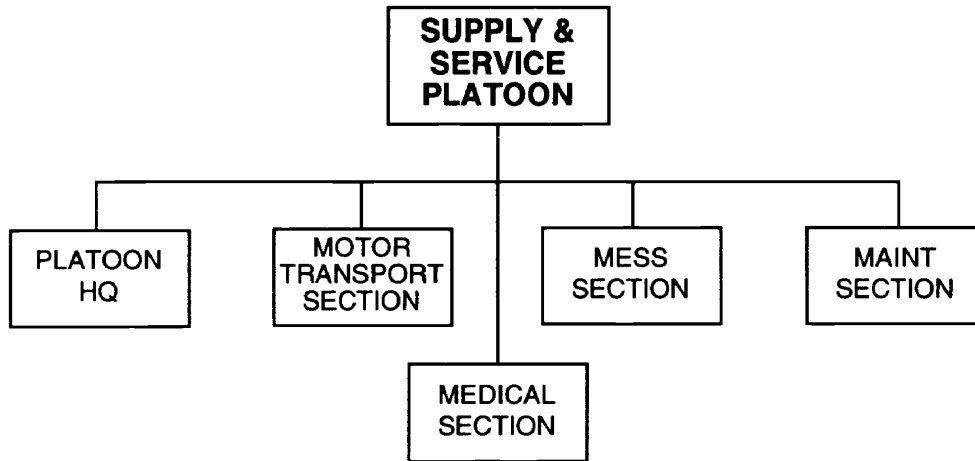

**PRINCIPAL ITEMS OF EQUIPMENT**

| <u>Equipment</u>                  | <u>Total</u> | <u>Equipment</u>                   | <u>Total</u> |
|-----------------------------------|--------------|------------------------------------|--------------|
| 9-mm Pistol, PM.....              | 1            | Trailer, Cargo, 1-Axle.....        | 5            |
| 5.45-mm Assault Rifle, AK-74..... | 20           | Trailer, Generator.....            | 1            |
| ATRL, RPG-18/22.....              | 1            | Trailer, Kitchen.....              | 3            |
| Truck, Utility.....               | 1            | Trailer, POL (1,200-Liter).....    | 2            |
| Truck, Light.....                 | 10           | Trailer, Water (900-Liter).....    | 3            |
| Truck, POL (4,000-Liter).....     | 2            | Night-Vision Goggles (Driver)..... | 3            |
| Van, Maintenance.....             | 1            | Radio, VHF, Manpack,               |              |
| Ambulance.....                    | 1            | Low-Power.....                     | 4            |

**Troop Transport Platoon,  
Commando Bn**

---

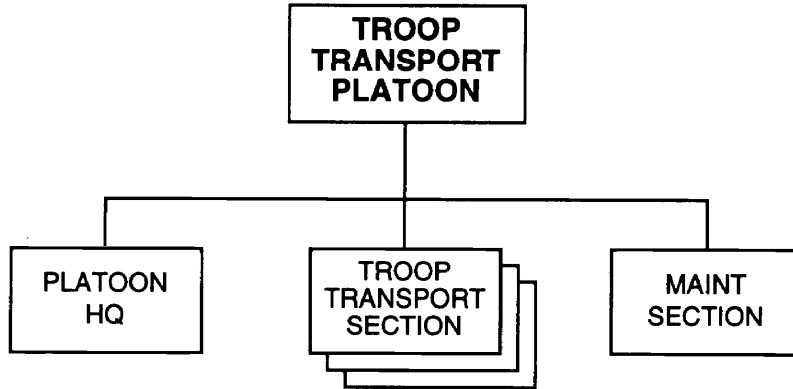

**PRINCIPAL ITEMS OF EQUIPMENT**

| <u>Equipment</u>                                   | <u>Total</u> | <u>Equipment</u>                     | <u>Total</u> |
|--|--------------|--------------------------------------|--------------|
| 9-mm Pistol, PM.....                               | 1            | Van, Maintenance .....               | 1            |
| 5.45-mm Assault Rifle, AK-74.....                  | 55           | Trailer, Cargo, 1-Axle.....          | 5            |
| 40-mm Under-Barrel Grenade Launcher,<br>BG-15..... | 3            | Trailer, POL (1,200-Liter) .....     | 1            |
| ATRL, RPG-18/22.....                               | 3            | Trailer, Water (900-Liter).....      | 2            |
| Truck, Light .....                                 | 24           | Night-Vision Goggles (Driver).....   | 3            |
| Truck, POL (4,000-Liter).....                      | 1            | Night-Vision Sight (Small Arms)..... | 5            |
|  |              | Radio, VHF, Portable, Low-Power..... | 2            |

*NOTE:* One or two trucks in each troop transport section may carry a 12.7-mm heavy machinegun or a 30-mm automatic grenade launcher. These weapons provide a minimum of fire support for the unit during movement by vehicle.

Navy

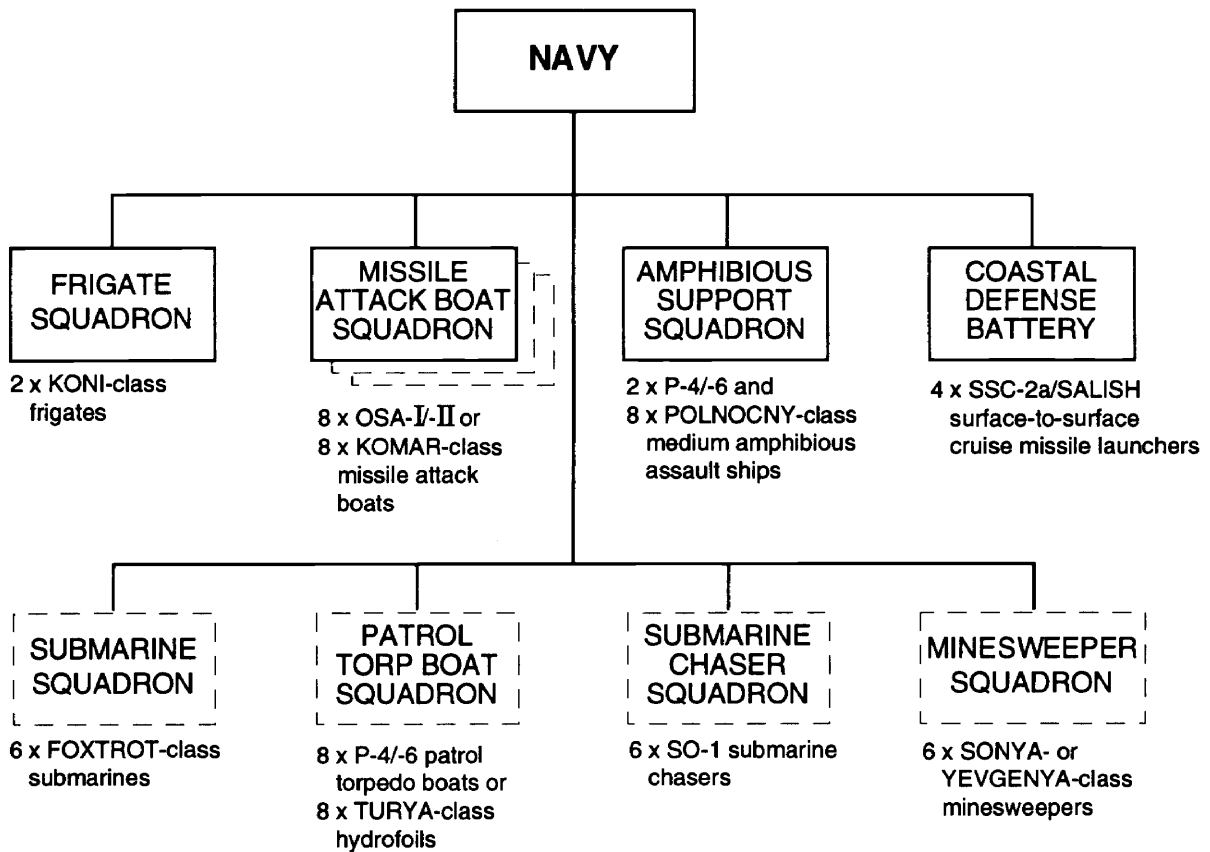

**NOTES:**

1. As with the Air Force, size and type of naval units depends on the size of the Ground Forces they support and the number and types of specialized missions they must conduct such as the number of amphibious support squadrons needed for special operations support.
2. Squadrons may be regionally affiliated, as with air defense units. For example, a region may have a missile attack boat squadron and patrol torpedo boat squadron stationed in one of the region's ports.
3. The upper line of the organization chart represents the baseline, even for a "brown water" force. A more capable navy would include organizations on the lower line.

**Directorate of Military Intelligence,  
General Staff**

---

Of the three primary directorates of the General Staff, the Directorate of Military Intelligence (DMI) plays a special role. It controls national-level intelligence assets and may allocate some of its forces to support Ground Forces organizations. The organization chart below represents only the portion of its assets which the DMI could allocate downward. It does not represent or define the intricate relationships among national-level structures and agencies.

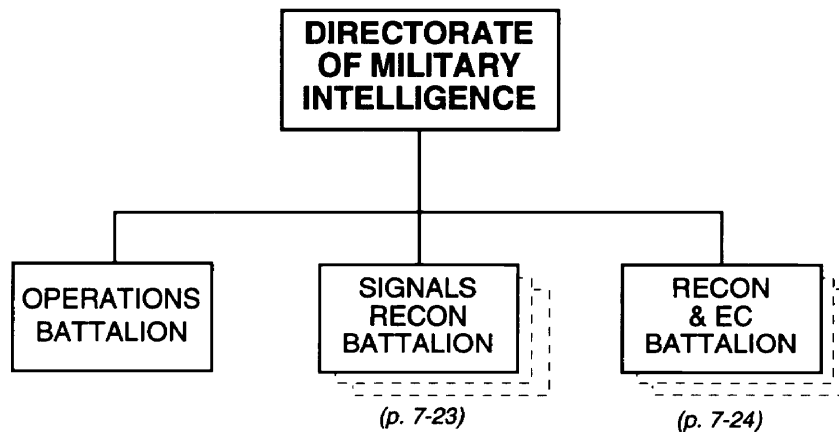

**NOTES:**

1. The directorate has only one operations battalion. This battalion always remains under DMI control. Its exact composition and equipment strength may vary. Functions of the battalion include special information (propaganda), counterintelligence (both overt and covert collection), and interrogation. Elements from each of these disciplines normally form tailored platoon- and company-sized teams. The DMI can allocate such teams to regions and districts based on their specific needs. Counterintelligence and interrogation assets are the most likely candidates for allocation.
2. Signals reconnaissance battalions normally remain under the control of the General Staff. However, the General Staff/Ground Forces Headquarters may allocate them to the regions or to an expeditionary army.
3. Reconnaissance and electronic combat (EC) battalions are similar to those organic to districts and divisions. However, the battalions belonging to the DMI are more likely to have a remotely-piloted vehicle squadron. The General Staff/Ground Forces Headquarters can allocate these battalions to military regions and their subordinate districts (particularly to those preparing for division- or army-level offensive actions).



## Signals Reconnaissance Battalion, DMI

---

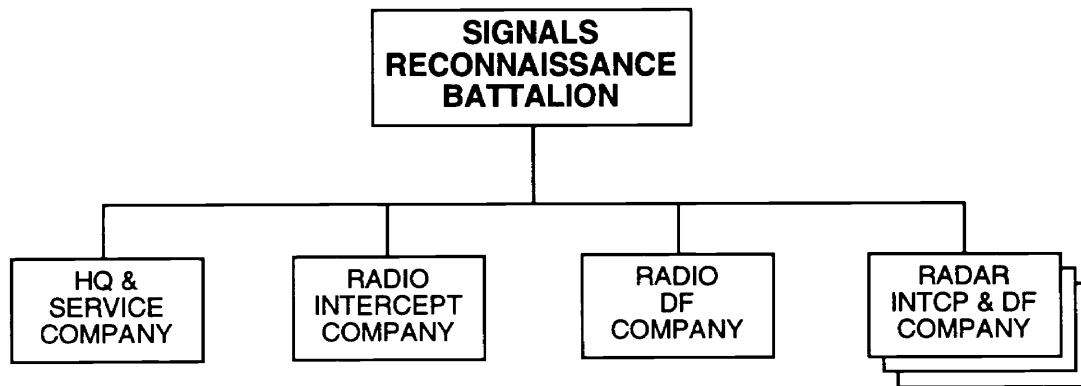

### NOTES:

1. Another possible name for this battalion is radio and radar intercept and direction-finding battalion.
2. Exact composition and equipment strengths vary. However, equipment types are basically of the tactical support variety, as shown in the reconnaissance and EC battalions (pp. 1-35 and 2-27).
3. The General Staff/Ground Forces Headquarters may allocate these battalions as a whole to support a region or army. It can also allocate individual companies to support specific district or region operations. The latter case is more probable when the organization requesting support has sufficient ground reconnaissance assets, but lacks the electronic combat capabilities of the reconnaissance and EC battalion.

**Reconnaissance and Electronic Combat  
Battalion, DMI**

---

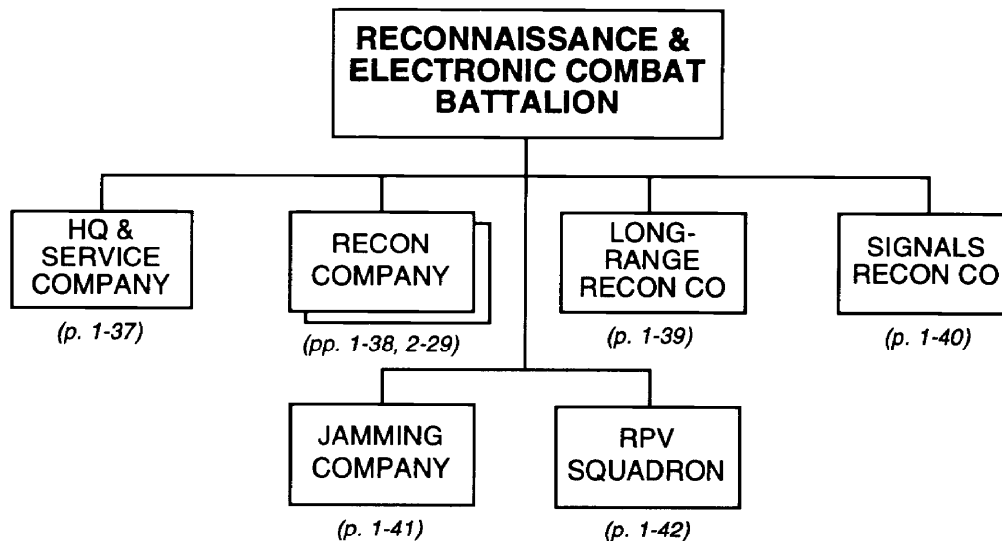

**NOTES:**

1. The General Staff normally allocates a reconnaissance and EC battalion, as a whole, to support a military region or expeditionary army. The region or army, in turn, may attach such a battalion to a subordinate military district or division that lacks an organic reconnaissance and EC battalion.
2. For a listing of the principal items of equipment for this battalion, see pp. 1-36 and 2-28.

## Internal Security Forces

---

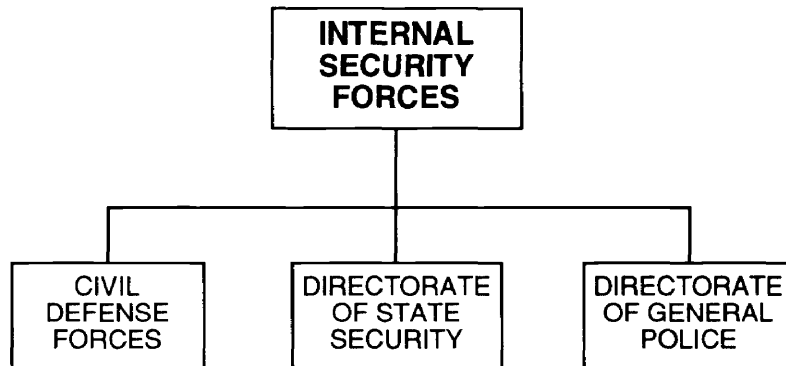

### NOTES.

1. During peacetime, the Ministry of the Interior (MININT) is responsible for internal security and all related functions. During wartime, however, the MININT's Internal Security Forces become subordinate to the Supreme High Command. The General Staff controls and supervises their activities.
2. Civil Defense Forces comprise a variety of nonmilitary units. The collective mission of these forces is to protect the population and economic centers against the effects of all types of natural disaster and warfare. The General Staff divides areas of responsibility into defense zones that correspond to military region and/or district boundaries. In peacetime, normal missions include emergency engineering, rescue, and similar disaster relief functions. During wartime, rear area security is their primary mission. Units have no standard structure; groupings vary according to each units' function. These functions range from repair and salvage, to fighting fires, to rendering first aid.
3. The Directorate of State Security is responsible for preventing counterrevolutionary activities, investigating these activities, and prosecuting the perpetrators. During times of crisis and wartime, the Directorate is also responsible for finding and neutralizing dissidents and spies. Elements of the Directorate deploy throughout the country, normally collocating with a military region/district headquarters.
4. The Directorate of General Police has responsibility for national and local police, fire protection, and the penal system.

# Chapter 8

## Air Force and Air Defense Command

Among the four branches of the OPFOR armed forces, the Air Force is the second largest, after the Ground Forces. It includes the Air Defense Command. The numbers and types of aviation and air defense units correspond to the size of the Ground Forces they support.

### CONTENTS

|  |      |
|--|------|
| <b>Air Force</b> .....   | 8-2  |
| Fighter-Bomber Aviation Regiment, Air Force .....                                | 8-3  |
| Ground-Attack Aviation Regiment, Air Force .....                                 | 8-3  |
| Combat Helicopter Regiment, Air Force .....                                      | 8-4  |
| Fighter-Interceptor Aviation Regiment, Air Force .....                           | 8-4  |
| Reconnaissance Aviation Regiment, Air Force .....                                | 8-5  |
| Airborne Jamming Aviation Regiment, Air Force .....                              | 8-5  |
| Separate Heliborne Jamming Squadron, Air Force .....                             | 8-6  |
| Transport Helicopter Regiment, Air Force .....                                   | 8-6  |
| Separate Helicopter Squadron, Air Force .....                                    | 8-7  |
| Transport Aviation Regiment, Air Force .....                                     | 8-8  |
| <b>Air Defense Command, Air Force</b> .....                                      | 8-9  |
| SAM Brigade (SA-2), ADC .....  | 8-10 |
| SAM Battalion (SA-2), SAM Bde (SA-2) .....                                       | 8-12 |
| SAM Brigade (SA-3), ADC .....  | 8-13 |
| SAM Battalion (SA-3), SAM Bde (SA-3) .....                                       | 8-15 |
| SAM Brigade (SA-4), ADC .....  | 8-16 |
| SAM Battalion (SA-4), SAM Bde (SA-4) .....                                       | 8-18 |
| Missile Firing Battery, SAM Bn (SA-4) .....                                      | 8-19 |
| SAM Brigade (SA-11), ADC .....   | 8-20 |
| SAM Battalion (SA-11), SAM Bde (SA-11) .....                                     | 8-22 |
| Missile Firing Battery, SAM Bn (SA-11) .....                                     | 8-23 |
| SAM Regiment (SA-8), ADC .....   | 8-24 |
| Regimental Headquarters, SAM Regt or Air Defense Regt .....                      | 8-26 |
| Target Acquisition/Early Warning Battery, SAM Regt or Air Defense Regt .....     | 8-27 |
| Missile Technical Battery, SAM Regt (SA-8) .....                                 | 8-28 |
| Missile Firing Battery, SAM Regt (SA-8) or SAM Bn (SA-8), Air Defense Regt ..... | 8-29 |
| Materiel Support Company, SAM Regt .....   | 8-30 |
| Maintenance Company, SAM Regt or Air Defense Regt .....                          | 8-31 |
| SAM Regiment (SA-6), ADC .....   | 8-32 |
| Missile Technical Battery, SAM Regt (SA-6) .....                                 | 8-34 |
| Missile Firing Battery, SAM Regt (SA-6) .....                                    | 8-35 |

**Air Force**

---

The OPFOR Air Force, including the Air Defense Command, is second only to the Ground Forces in size. Its size and composition depend on the size of the Ground Forces it supports and the number and types of aircraft required for specialized missions. Such missions can include support to airborne forces or the Special Operations Command. The organization chart below does not depict a fixed structure. Rather, it depicts the various *types* of regiments and squadrons that could be present in the Air Force structure.

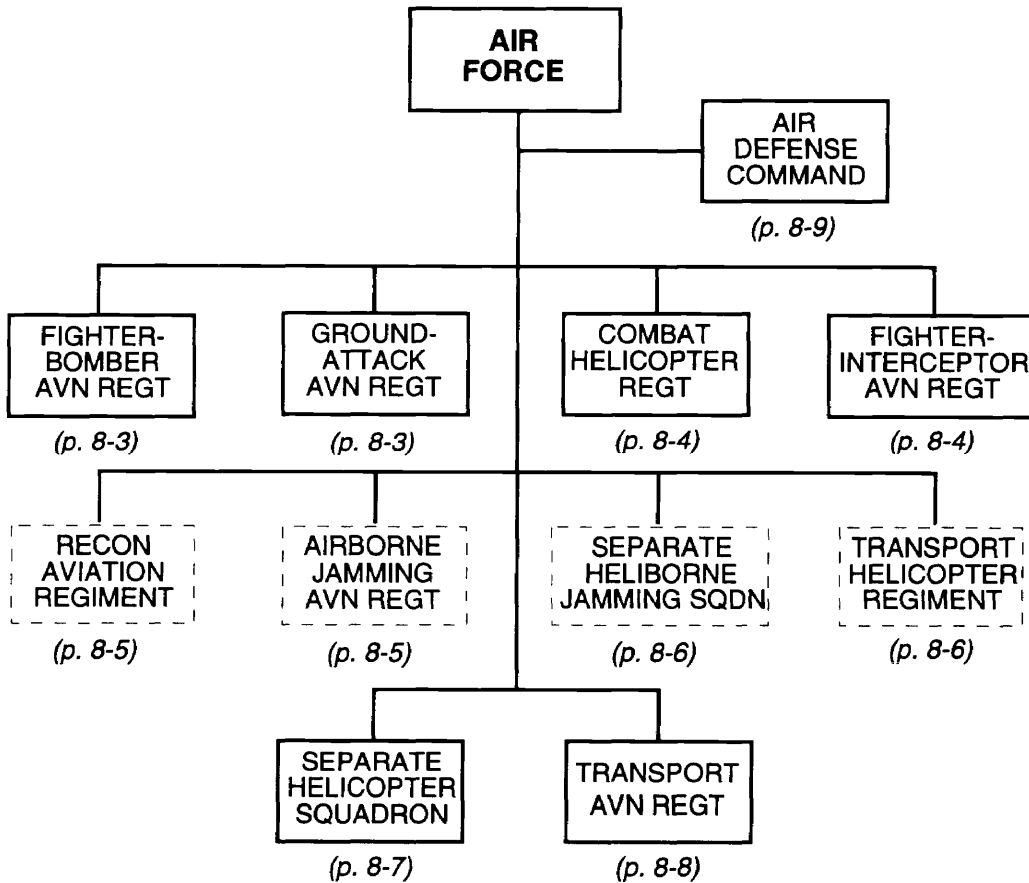

NOTE: Air Force units with *aviation* in their name generally consist of fixed-wing aircraft.

**Fighter-Bomber Aviation Regiment,  
Air Force** \_\_\_\_\_

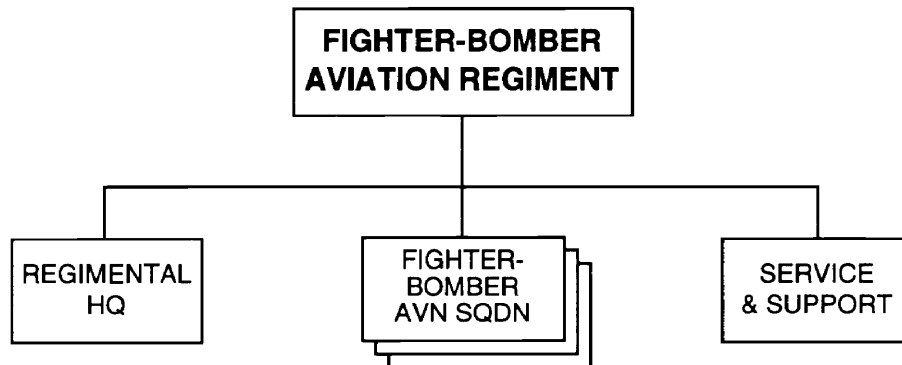

*NOTE:* This regiment normally contains pure squadrons of the MiG- 17/FRESCO, MiG-19/FARMER, 27/FLOGGER D/J, and/or Su-24/FENCER A/C fighter-bomber aircraft. If equipped with Su-24/FENCER aircraft, this regiment may be called a bomber aviation regiment. Each squadron normally has 12 aircraft. This total includes up to 2 training aircraft per squadron that can also serve as combat aircraft.

**Ground-Attack Aviation Regiment, Air Force** \_\_\_\_\_

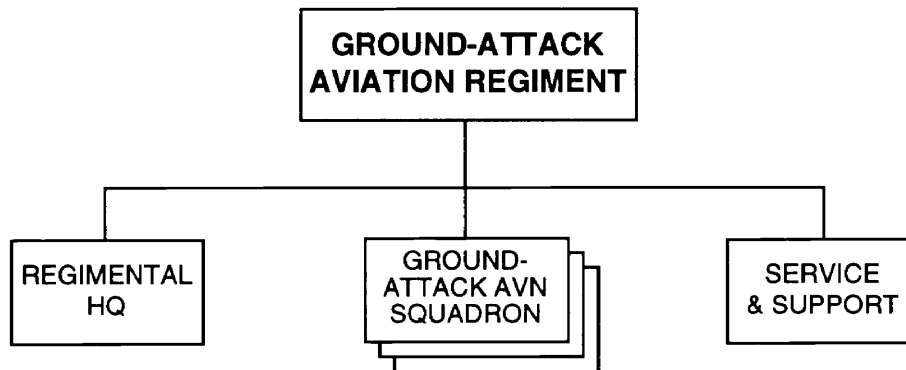

*NOTE:* This regiment normally contains pure squadrons of the MiG-17/FRESCO, MiG-19/FARMER, Su-7B/FITTER A, Su-17/FITTER C/D/H, and/or the Su-24 FENCER A/C ground-attack aircraft. Each squadron normally has 12 aircraft. This total includes up to 2 training aircraft per squadron that can also serve as combat aircraft. A more modernized Air Force could have at least one squadron of Su-25/FROGFOOT ground-attack aircraft, plus 2 Su-25UB trainers.

**Combat Helicopter Regiment,  
Air Force**

---

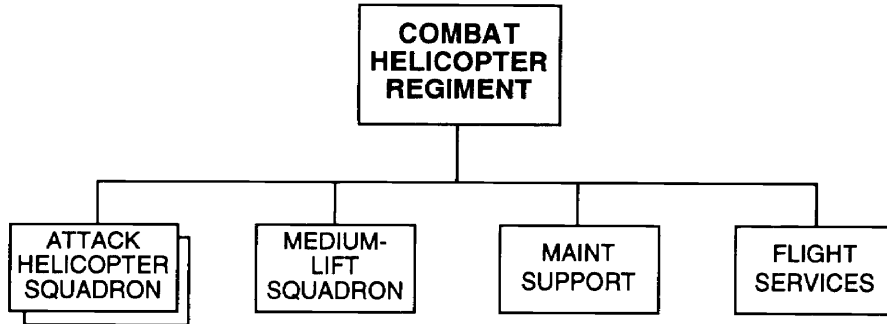

**PRINCIPAL ITEMS OF EQUIPMENT**

| <u>Equipment</u>                                    | <u>Total</u> | <u>Equipment</u>   | <u>Total</u> |
|---|--------------|--|--------------|
| Attack Helicopter,<br>Mi-24(Mi-25)/HIND/D/E/F ..... | 30-40        | Medium Helicopter, Mi-8T/HIP C/E or<br>Mi-8MT(Mi-17)/HIP H ..... | 15-20        |

**NOTES:**

1. Some combat helicopter regiments also include six Mi-24R/HIND G 1 NBC-sampling helicopters and six Mi-24K/HIND G2 photoreconnaissance helicopters.
2. Standard squadron strength is either 15 or 20 aircraft.
3. Some combat helicopter regiments have two squadrons of Mi-2/HOPLITE instead of the Mi-24(Mi-25)/HIND. One or both of these squadrons could have HOPLITEs configured as lightly armed helicopters. If so, these variants can carry a variety of armaments.

**Fighter-Interceptor Aviation Regiment,  
Air Force**

---

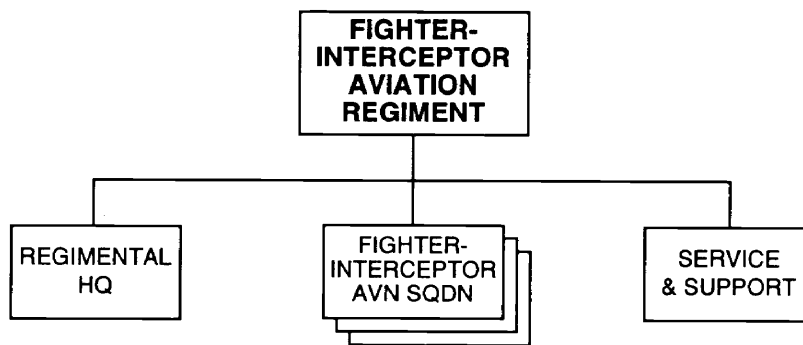

**NOTE:** This regiment normally contains pure squadrons of the Mig-17/FRESCO, MiG-19/FARMER, MiG-2/FISHBED J, MiG-23/FLOGGER B/E/G, and/or Su-27/FLANKER B fighter-interceptor aircraft. A more modernized Air Force could have one squadron of MiG-29/FULCRUM. Each squadron normally has 12 aircraft. This total includes up to 2 training aircraft per squadron that can also serve as combat aircraft.

**Reconnaissance Aviation Regiment,  
Air Force** \_\_\_\_\_

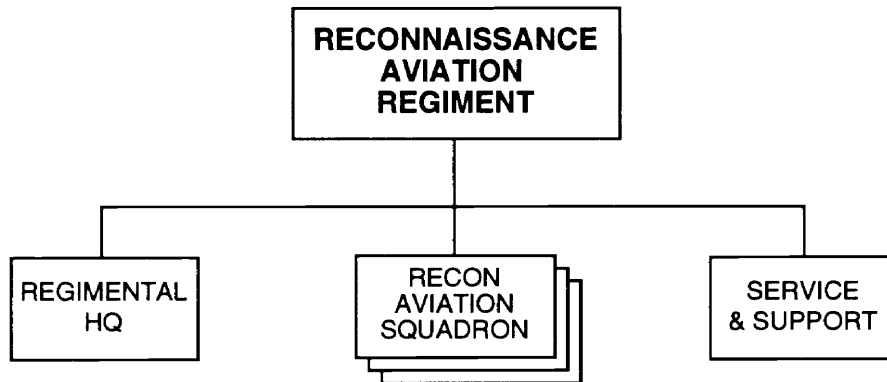

*NOTES:*

1. The reconnaissance aviation squadrons of this regiment may have reconnaissance variants of the following aircraft: Su-24/FENCER, Su-17/FITTER, or MiG-25/FOXBAT B/D. Each squadron normally has 16 aircraft. This total includes up to 4 training aircraft per squadron that can also perform reconnaissance.
2. This type of specialized regiment appears only in larger Air Force structures.

**Airborne Jamming Aviation Regiment,  
Air Force** \_\_\_\_\_

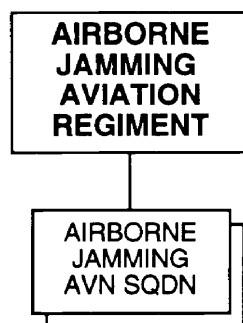

*NOTES:*

1. This regiment may have a squadron of Su-24/FENCER jamming variants and a squadron of Yak-28/BREWER E jamming variants. Each squadron normally has 12 aircraft.
2. This regiment appears only in larger Air Force structures.



**Separate Heliborne Jamming Squadron,  
AIR Force**

---

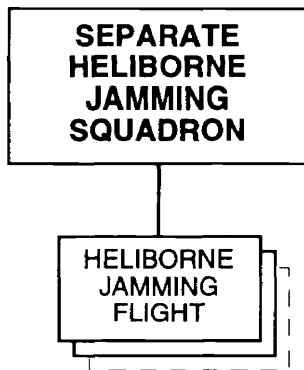

**NOTES:**

1. This squadron may have one or two Mi-8T/HIP C medium helicopters and 14 to 21 jamming variants of the types Mi-8PPA (HIP J) and Mi-8SMV (HIP K).
2. This type of specialized squadron appears only in larger Air Force structures and/or structures heavier in rotary-wing aircraft.

**Transport Helicopter Regiment,  
AIR Force**

---

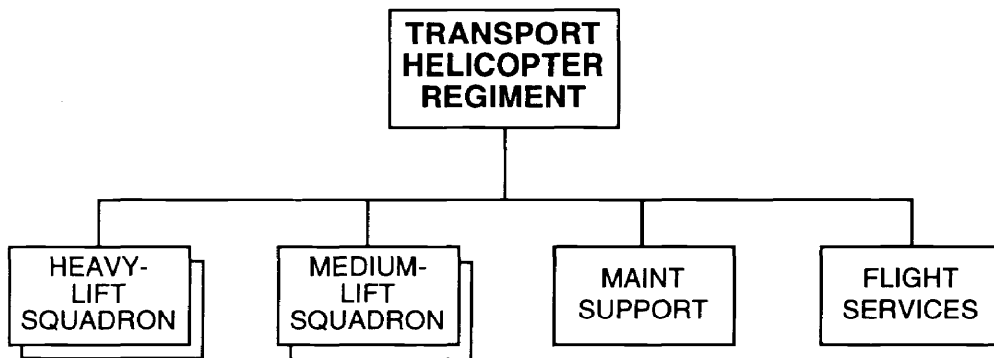

**PRINCIPAL ITEMS OF EQUIPMENT**

| <u>Equipment</u>   | <u>Total</u> | <u>Equipment</u>   | <u>Total</u> |
|--|--------------|--|--------------|
| Heavy-Lift Helicopter, Mi-6A/HOOK or<br>Mi-26/HALO A ..... | 24           | Medium Helicopter, Mi-8T/HIP C or<br>Mi-8MT(Mi-17)/HIP H ..... | 24           |

**NOTES:**

1. Some of the medium helicopters may be Mi-8S VIP variants or Mi-8VKP airborne command post variants.
2. Although uncommon, some regiments have substituted a light helicopter squadron for one of the medium-lift squadrons, using the Mi-2iHOPLITE.

**Separate Helicopter Squadron,  
Air Force**

---

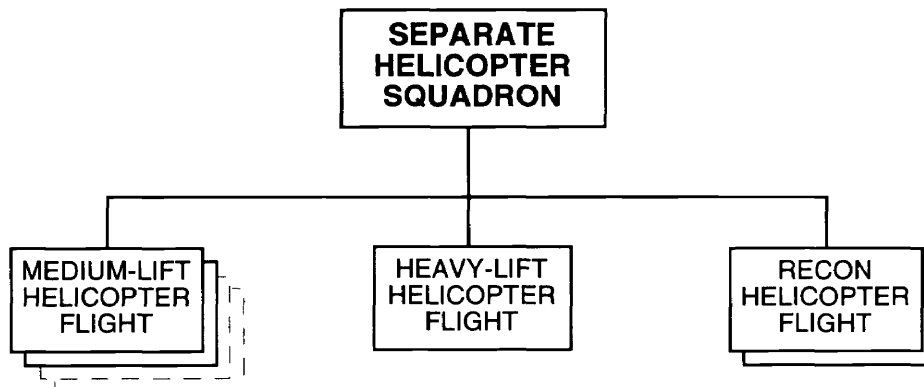

**PRINCIPAL ITEMS OF EQUIPMENT**

| <u>Equipment</u>   | <u>Total</u> | <u>Equipment</u>                                 | <u>Total</u> |
|--|--------------|--|--------------|
| Medium Helicopter, Mi-8T/HIP C/E or<br>Mi-8MT(Mi-17)/HIP H ..... | 6-12         | NBC-Sampling Helicopter,<br>Mi-24R/HIND G1 ..... | 2            |
| Heavy-Lift Helicopter, Mi-6A/HOOK<br>or Mi-26/HALO A .....       | 1-2          | Photorecon Helicopter,<br>Mi-24K/HIND G2.....    | 2            |

**NOTES:**

1. Some separate helicopter squadrons may also have two or three Mi-8SMV or Mi-8PPA jamming helicopters. Some squadrons may also have one or two Mi-8VKP airborne command post helicopters.
2. Some Air Force structures have a separate mixed aviation squadron with helicopter assets similar to those of a separate helicopter squadron (less the reconnaissance and jamming helicopters), plus 12 to 24 light-to-medium fixed-wing transport aircraft.
3. A smaller Air Force may have its rotary-wing aircraft organized solely in this manner, rather than the regimental structure predominant in larger forces.

Transport Aviation Regiment,  
Air Force

---

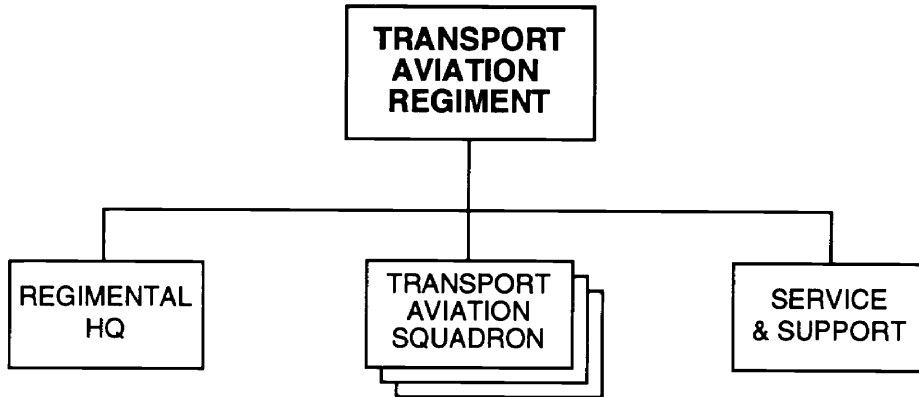

*NOTE:* This regiment normally contains pure squadrons of the An-2/COLT light transport, 11-18/COOT, and An-26/CURL light transport aircraft. Each squadron has either 16 or 20 aircraft. Some regiments have a squadron of An-12/CUB medium transports, which also have an electronic combat or reconnaissance configuration.

**Air Defense Command,  
Air Force**

---

The Air Defense Command (ADC) contains brigades and regiments of either surface-to-air missiles (SAMs) or anti-aircraft (AA) guns. Maintaining single-system units allows the ADC to manage limited assets, tailoring support to a particular region or air defense zone. The following organization chart represents the **types** of air defense units that may be available to the ADC. The number of each type can vary.

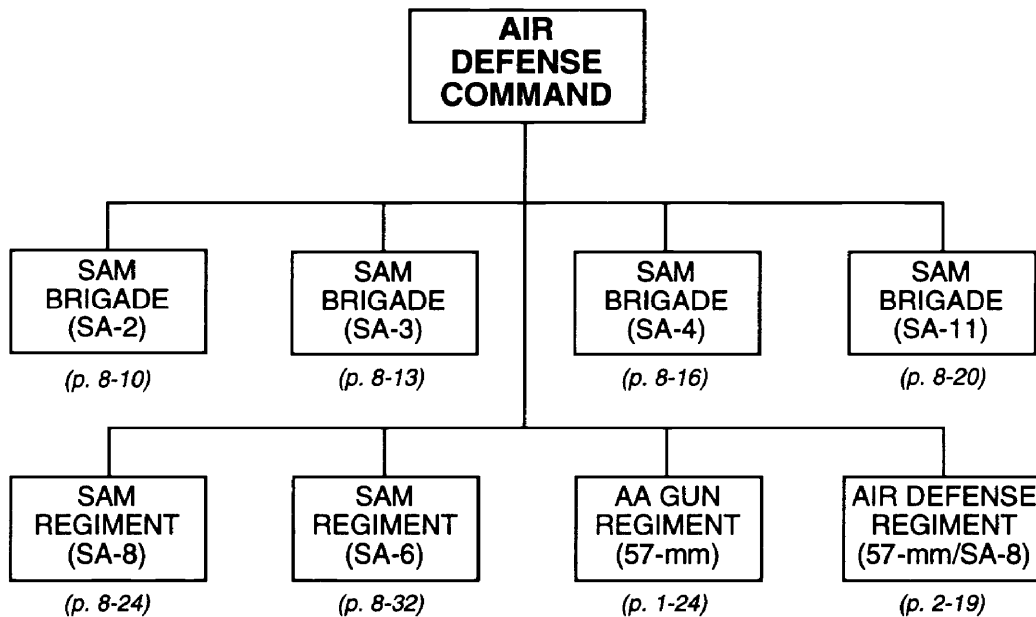

**NOTES:**

1. Numbers and types of air defense regiments and brigades depend on the number and importance of air defense zones/regions they have to defend. Assets may have a habitual regional affiliation, or the General Staff/National Headquarters may tailor support as mission dictates.
2. In addition, the ADC may have an air defense jamming battalion or perhaps an air defense jamming regiment with up to three such battalions. Each battalion can have up to 54 air defense jammers, along with supporting target acquisition systems.

**FOOTNOTE:** \* This air defense regiment with a mix of AA gun and SAM battalions is an exception to the norm of single-system units. This regiment is particularly suited for allocation to a high-priority region or district. This allocation could support the mobilization of an expeditionary army or a mechanized infantry division.

SAM Brigade (SA-2),  
ADC

---

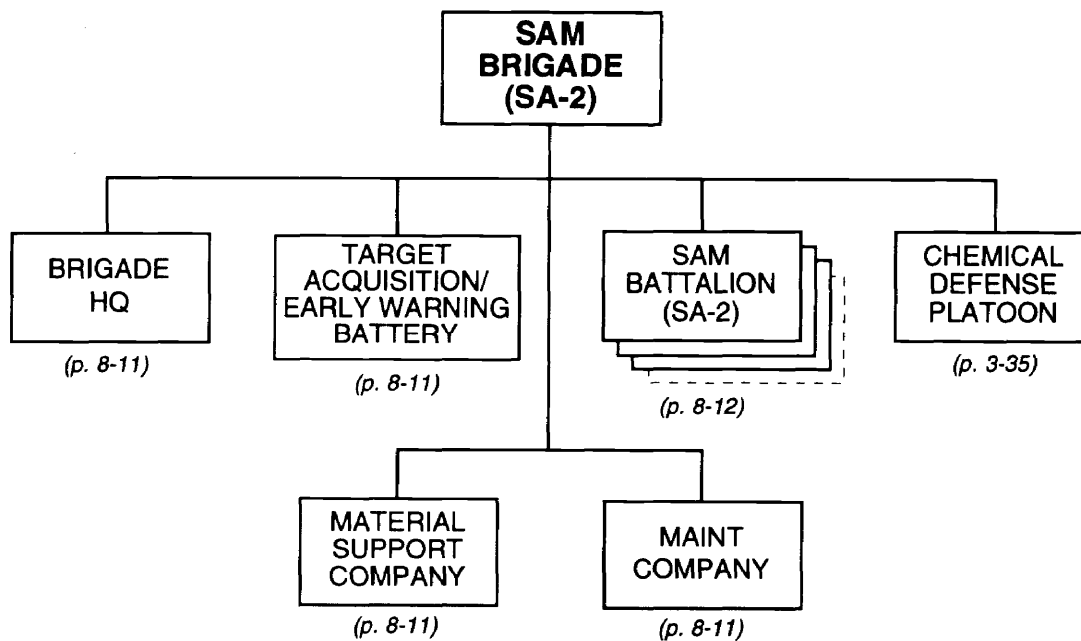

**NOTES:**

1. This SAM brigade may have three or four SAM battalions. The three-battalion organization may bear the designation of regiment, rather than brigade. Equipment totals below are for the three-battalion version.
2. SA-2 battalions could combine with other SAM/AA gun units to provide specialized support to a specific region or district.

**(continued)**

SAM Brigade (SA-2),  
ADC (continued)

| <i>Principal Items of Equipment</i>          | <i>Brigade HQ</i> | <i>Target Acquisition/Early Warning Btry</i> | <i>SAM Bn (SA-2) (3x)</i> | <i>Chemical Defense Plt</i> | <i>Materiel Support Co</i> | <i>Maintenance Co</i> | <i>TOTAL</i> |
|--|-------------------|--|---------------------------|-----------------------------|----------------------------|-----------------------|--------------|
| <b>ARMORED VEHICLES</b>                      |                   |  |                           |                             |                            |                       |              |
| Chem Recon Vehicle, BRDM-2RKh/RKhM           |                   |  |                           | 3                           |                            |                       | 3            |
| <b>WEAPONS</b>                               |                   |  |                           |                             |                            |                       |              |
| SAM, SA-2/GUIDELINE Launcher                 |                   |  | 18                        |                             |                            |                       | 18           |
| SAM, Shoulder-Fired                          | 3                 |  | 9                         |                             |                            |                       | 12           |
| <b>TRUCKS</b>                                |                   |  |                           |                             |                            |                       |              |
| Truck, Utility                               | 1                 | 2  | 6                         |                             | 3                          | 1                     | 13           |
| Truck, Light                                 | 3                 | 1  | 6                         |                             | 2                          | 1                     | 13           |
| Truck, Medium                                |                   |  | 24                        |                             | 25                         | 3                     | 52           |
| Truck, Decon, ARS-12U/14                     |                   |  |                           | 3                           |                            |                       | 3            |
| Truck, Decon, DDA-53/66                      |                   |  |                           | 1                           |                            |                       | 1            |
| Truck, Crane                                 |                   |  | 3                         |                             |                            | 1                     | 4            |
| Truck, POL (5,000-L)                         |                   |  | 3                         |                             | 3                          |                       | 6            |
| Truck, Water (2,000-L)                       |                   |  |                           | 2                           | 2                          |                       | 4            |
| Van Computer                                 |                   | 1  |                           |                             |                            |                       | 1            |
| Van, Maintenance                             |                   | 1  | 9                         |                             | 2                          | 8                     | 20           |
| Van, Medium                                  | 2                 |  |                           |                             |                            |                       | 2            |
| Van, Radar                                   |                   | 2  | 6                         |                             |                            |                       | 8            |
| Van, Signal                                  | 4                 |  | 3                         |                             |                            |                       | 7            |
| Ambulance                                    | 2                 |  |                           |                             |                            |                       | 2            |
| <b>TRAILERS</b>                              |                   |  |                           |                             |                            |                       |              |
| Trailer, Cargo, 1-Axle                       |                   | 1  | 3                         |                             |                            |                       | 4            |
| Trailer, Cargo, 2-Axle                       |                   | 1  | 6                         |                             | 5                          | 3                     | 15           |
| Trailer, Generator                           | 1                 |  | 6                         |                             | 2                          | 2                     | 11           |
| Trailer, Kitchen                             | 1                 | 1  | 3                         |                             | 3                          | 1                     | 9            |
| Trailer, POL (4,200-L)                       |                   |  | 3                         |                             | 3                          |                       | 6            |
| Trailer, Van                                 | 4                 | 1  | 3                         |                             |                            |                       | 8            |
| Trailer, Water (900-/1,200-L)                |                   |  | 6                         | 2                           | 1                          | 1                     | 10           |
| <b>RADARS</b>                                |                   |  |                           |                             |                            |                       |              |
| Radar, Tgt Acq, SPOON REST                   |                   | 1  | 3                         |                             |                            |                       | 4            |
| Radar, Aer. Surv./Tgt Acq, FLAT FACE         |                   | 1  |                           |                             |                            |                       | 1            |
| Radar, Fire Control, FAN SONG                |                   |  | 3                         |                             |                            |                       | 3            |
| Radar, Height Finding, THIN SKIN or SIDE NET |                   | 1  |                           |                             |                            |                       | 1            |
| <b>RADIOS</b>                                |                   |  |                           |                             |                            |                       |              |
| VHF, Manpack, Low-Power                      | 1                 | 2  | 12                        |                             | 1                          | 1                     | 17           |
| VHF, Portable, Low-Power                     |                   |  |                           |                             |                            |                       | 0            |
| VHF, Portable, Very-Low-Power                | 1                 |  | 3                         |                             |                            |                       | 4            |
| VHF, Vehicle Mount, Medium-Power             |                   | 3  |                           | 3                           |                            |                       | 6            |
| HF, Manpack, Low-Power                       |                   | 2  |                           | 1                           |                            |                       | 3            |
| HF/VHF, Vehicle Mount, Med-Power             | 3                 |  |                           |                             |                            |                       | 3            |
| HF/VHF, Vehicle Mount, High-Power            | 1                 |  |                           |                             |                            |                       | 1            |
| Radio Relay, VHF/UHF                         | 1                 | 1  | 3                         |                             |                            |                       | 5            |
| Warning Receiver                             | 2                 |  | 3                         |                             |                            |                       | 5            |
| <b>MISCELLANEOUS</b>                         |                   |  |                           |                             |                            |                       |              |
| SA-2 Missile Transporter (Tractor-Trailer)   |                   |  | 18                        |                             |                            |                       | 18           |

SAM Battalion (SA-2),  
SAM Bde (SA-2)

---

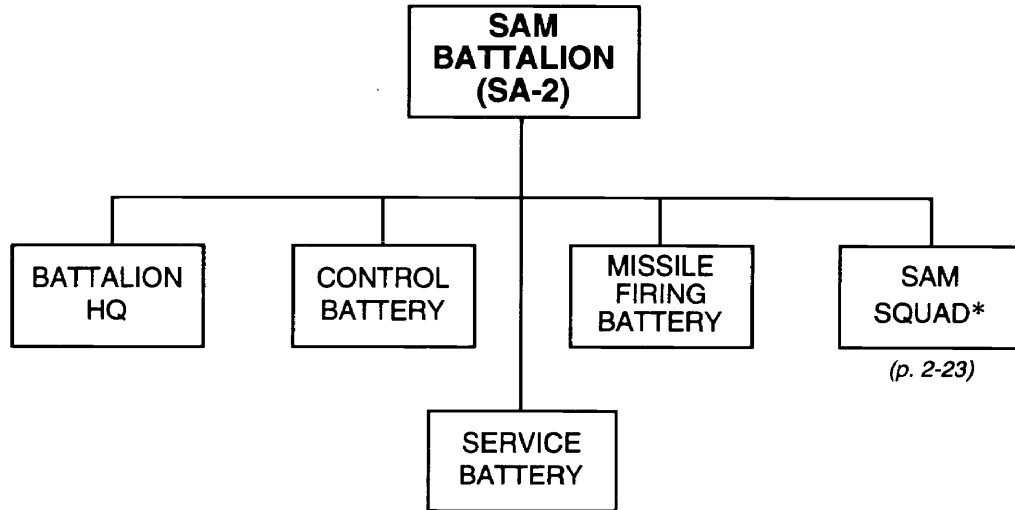

**PRINCIPAL ITEMS OF EQUIPMENT**

| <u>Equipment</u>                   | <u>Total</u> | <u>Equipment</u>                     | <u>Total</u> |
|------------------------------------|--------------|--------------------------------------|--------------|
| SAM, SA-2/GUIDELINE Launcher ..... | 6            | Trailer, Generator.....              | 1            |
| SA-2 Missile Transporter           |              | Trailer, Kitchen.....                | 1            |
| (Tractor-Trailer).....             | 6            | Trailer, POL (4,200-Liter) .....     | 1            |
| SAM, Shoulder-Fired*.....          | 3            | Trailer, Van.....                    | 1            |
| Truck, Utility .....               | 2            | Trailer, Water (900-Liter) .....     | 2            |
| Truck, Light* .....                | 2            | Radars:                              |              |
| Truck, Medium .....                | 8            | Target Acquisition, SPOON REST ..... | 1            |
| Truck, Crane .....                 | 1            | Fire Control, FAN SONG.....          | 1            |
| Truck, POL (5,000-Liter).....      | 2            | Radios:                              |              |
| Van, Maintenance .....             | 3            | VHF, Manpack, Low-Power.....         | 4            |
| Van, Radar .....                   | 2            | VHF, Portable, Very-Low-Power* ..... | 1            |
| Van, Signal.....                   | 1            | Radio Relay, VHF/UHF.....            | 1            |
| Trailer, Cargo, 1-Axle.....        | 1            | Warning Receiver .....               | 1            |
| Trailer, Cargo, 2-Axle.....        | 2            |                                      |              |

**FOOTNOTE:** \* Instead of this SAM squad, some battalions may have an AA gun section with two 23-mm AA guns, ZU-23. Other battalions may have a battery of six 14.5-mm AA heavy machineguns (p. 2-5). Because of this, the numbers of trucks and radios may also vary.

**SAM Brigade (SA-3),  
ADC**

---

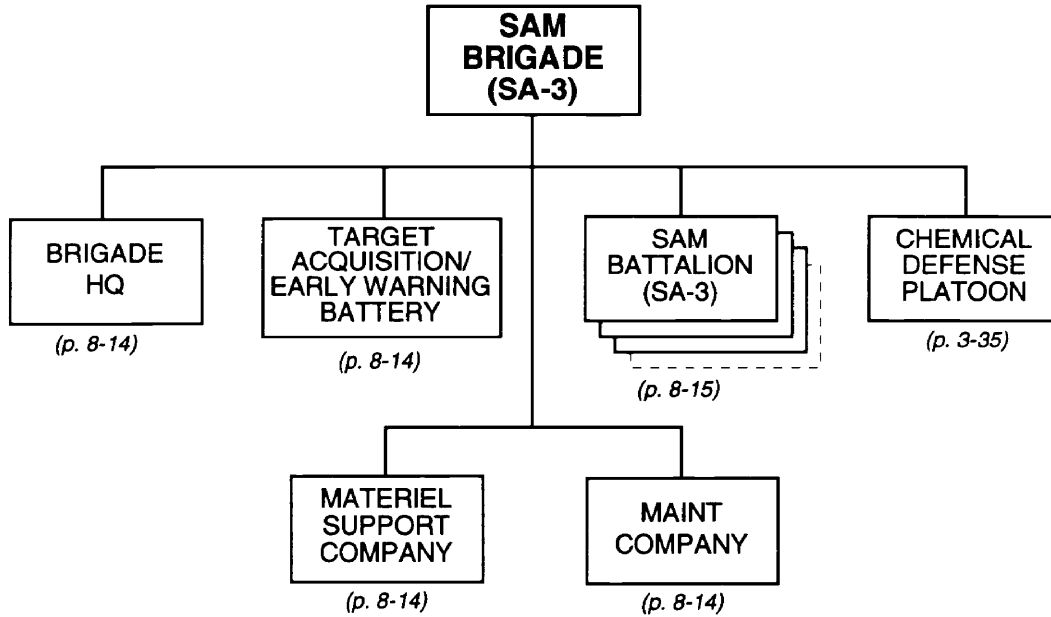

**NOTES:**

1. This SAM brigade may have three or four SAM battalions. Either the three- or four-battalion organization may bear the designation of regiment, rather than brigade. Depending on the area requiring air defense coverage, an SA-3 brigade could have as many as six battalions. Equipment totals below are for the four-battalion version.
2. SA-3 battalions could combine with other SAM/AA gun units to provide specialized support to a specific region or district.

**(continued)**



SAM Brigade (SA-3),  
ADC

| <i>Principal Items of Equipment</i>     | <i>Brigade HQ</i> | <i>Target Acquisition/Early Warning Btry</i> | <i>SAM Bn (SA-3) (4x)</i> | <i>Chemical Defense Plt</i> | <i>Materiel Support Co</i> | <i>Maintenance Co</i> | <i>TOTAL</i> |
|---|-------------------|--|---------------------------|-----------------------------|----------------------------|-----------------------|--------------|
| <b>ARMORED VEHICLES</b>                 |                   |  |                           |                             |                            |                       |              |
| Chem Recon Vehicle, BRDM-2RKh/RKhM      |                   |  |                           | 3                           |                            |                       | 3            |
| <b>WEAPONS</b>                          |                   |  |                           |                             |                            |                       |              |
| SAM, SA-3/GOA Launcher                  |                   |  | 16                        |                             |                            |                       | 16           |
| SAM, Shoulder-Fired                     | 3                 |  | 12                        |                             |                            |                       | 15           |
| <b>TRUCKS</b>                           |                   |  |                           |                             |                            |                       |              |
| Truck, Utility                          | 1                 | 2  | 8                         |                             | 3                          | 1                     | 15           |
| Truck, Light                            | 3                 | 1  | 4                         |                             | 2                          | 1                     | 11           |
| Truck, Medium                           |                   |  | 16                        |                             | 25                         | 3                     | 44           |
| Truck, Decon, ARS-12U/14                |                   |  |                           | 3                           |                            |                       | 3            |
| Truck, Decon, DDA-53/66                 |                   |  |                           | 1                           |                            |                       | 1            |
| Truck, Crane                            |                   |  | 4                         |                             |                            | 1                     | 5            |
| Truck, POL (5,000-L)                    |                   |  | 4                         |                             | 3                          |                       | 7            |
| Truck, Water (2,000-L)                  |                   |  |                           | 2                           | 2                          |                       | 4            |
| Van Computer                            |                   | 1  |                           |                             |                            |                       | 1            |
| Van, Maintenance                        |                   | 1  | 8                         |                             | 2                          | 8                     | 19           |
| Van, Medium                             | 2                 |  |                           |                             |                            |                       | 2            |
| Van, Radar                              |                   | 2  | 4                         |                             |                            |                       | 6            |
| Van, Signal                             | 4                 |  | 4                         |                             |                            |                       | 8            |
| Ambulance                               | 2                 |  |                           |                             |                            |                       | 2            |
| <b>TRAILERS</b>                         |                   |  |                           |                             |                            |                       |              |
| Trailer, Cargo, 1-Axle                  |                   | 1  | 4                         |                             |                            |                       | 5            |
| Trailer, Cargo, 2-Axle                  |                   | 1  | 8                         |                             | 5                          | 3                     | 17           |
| Trailer, Generator                      | 1                 |  | 8                         |                             | 2                          | 2                     | 13           |
| Trailer, Kitchen                        | 1                 | 1  | 4                         |                             | 3                          | 1                     | 10           |
| Trailer, POL (4,200-L)                  |                   |  | 4                         |                             | 3                          |                       | 7            |
| Trailer, Van                            | 4                 | 1  | 4                         |                             |                            |                       | 9            |
| Trailer, Water (900-/1,200-L)           |                   |  | 8                         | 2                           | 1                          | 1                     | 12           |
| <b>RADARS</b>                           |                   |  |                           |                             |                            |                       |              |
| Radar, Tgt Acq, SPOON REST              |                   | 1  |                           |                             |                            |                       | 1            |
| Radar, Tgt Acq, FLAT FACE or SQUAT EYE  |                   | 1  | 4                         |                             |                            |                       | 5            |
| Radar, Fire Control, LOW BLOW           |                   |  | 4                         |                             |                            |                       | 4            |
| Radar, Height Finding, THIN SKIN        |                   | 1  |                           |                             |                            |                       | 1            |
| <b>RADIOS</b>                           |                   |  |                           |                             |                            |                       |              |
| VHF, Manpack, Low-Power                 | 1                 | 2  | 16                        |                             | 1                          | 1                     | 21           |
| VHF, Portable, Very-Low-Power           | 1                 |  | 4                         |                             |                            |                       | 5            |
| VHF, Vehicle Mount, Medium-Power        |                   | 3  |                           | 3                           |                            |                       | 6            |
| HF, Manpack, Low-Power                  |                   | 2  |                           | 1                           |                            |                       | 3            |
| HF/VHF, Vehicle Mount, Med-Power        | 4                 |  |                           |                             |                            |                       | 4            |
| HF/VHF, Vehicle Mount, High-Power       | 2                 |  |                           |                             |                            |                       | 2            |
| Radio Relay, VHF/UHF                    | 1                 | 1  | 4                         |                             |                            |                       | 6            |
| Warning Receiver                        | 2                 |  | 4                         |                             |                            |                       | 6            |
| <b>MISCELLANEOUS</b>                    |                   |  |                           |                             |                            |                       |              |
| SA-3 Missile Transporter (Medium Truck) |                   |  | 16                        |                             |                            |                       | 16           |

**SAM Battalion (SA-3),  
SAM Bde (SA-3)**

---

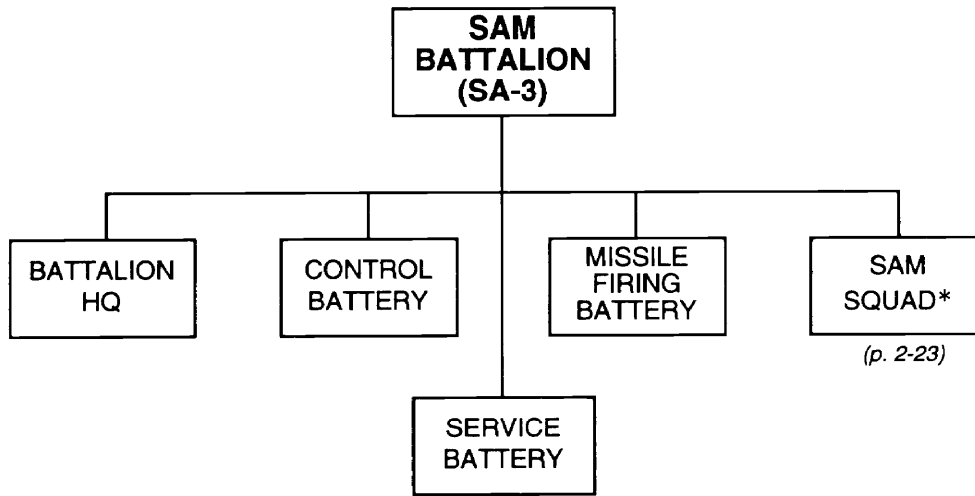

**PRINCIPAL ITEMS OF EQUIPMENT**

| <u>Equipment</u>                                | <u>Total</u> | <u>Equipment</u>                     | <u>Total</u> |
|---|--------------|--------------------------------------|--------------|
| SAM, SA-3/GOA Launcher.....                     | 4            | Trailer, Cargo, 2-Axle.....          | 2            |
| SA-3 Missile Transloader<br>(Medium Truck)..... | 4            | Trailer, Generator.....              | 2            |
| SA-3 Missile Transporter<br>(Medium Truck)..... | 4            | Trailer, Kitchen.....                | 1            |
| SAM, Shoulder-Fired*.....                       | 3            | Trailer, POL (4,200-Liter) .....     | 1            |
| Truck, Utility .....                            | 2            | Trailer, Van .....                   | 1            |
| Truck, Light* .....                             | 1            | Trailer, Water (1,200-Liter) .....   | 2            |
| Truck, Medium .....                             | 4            | Radars:                              |              |
| Truck, Crane .....                              | 1            | Target Acquisition, FLAT FACE        |              |
| Truck, POL (5,000-Liter).....                   | 1            | or SQUAT EYE.....                    | 1            |
| Van, Maintenance .....                          | 2            | Fire Control, LOW BLOW .....         | 1            |
| Van, Radar .....                                | 1            | Radios:                              |              |
| Van, Signal.....                                | 1            | VHF, Manpack, Low-Power.....         | 4            |
| Trailer, Cargo, 1-Axle.....                     | 1            | VHF, Portable, Very-Low-Power* ..... | 1            |
|   |              | Radio Relay, VHF/UHF.....            | 1            |
|   |              | Warning Receiver .....               | 1            |

**FOOTNOTE:** \* Instead of this SAM squad, some battalions may have an AA gun section with two 23-mm AA guns ZU-23. Other battalions may have a battery of six 14.5-mm AA heavy machineguns (p. 2-5). Because of this, the numbers of trucks and radios may also vary.

SAM Brigade (SA-4),  
ADC

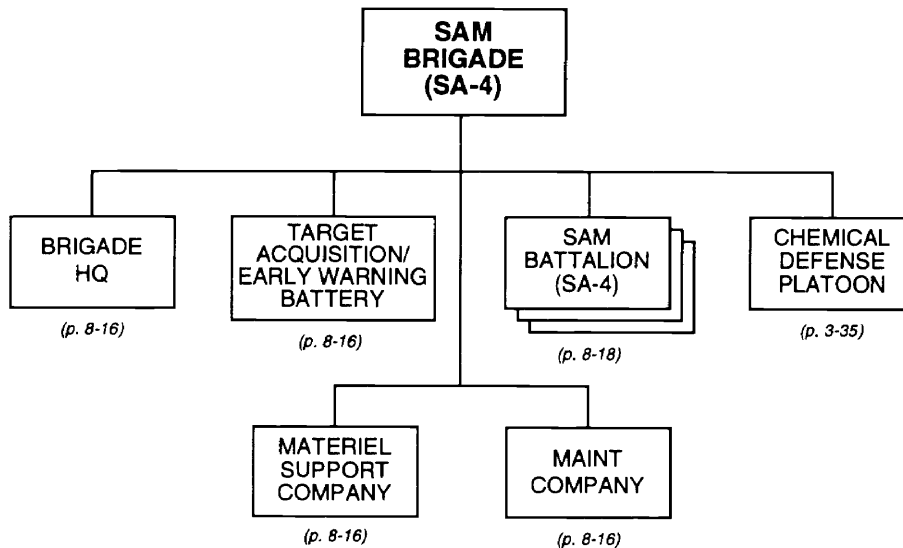

| <i>Principal Items of Equipment</i>      | <i>Brigade HQ</i> | <i>Target Acquisition/Early Warning Btry</i> | <i>SAM Bn (SA-4) (3x)</i> | <i>Chemical Defense Plt</i> | <i>Materiel Support Co</i> | <i>Maintenance Co</i> | <i>TOTAL</i> |
|--|-------------------|--|---------------------------|-----------------------------|----------------------------|-----------------------|--------------|
| <b>ARMORED VEHICLES</b>                  |                   |  |                           |                             |                            |                       |              |
| ACV, BTR-60 (PU-12)                      | 1                 |  | 12                        |                             |                            |                       | 13           |
| Fire Control Radar Vehicle (TEL Chassis) |                   |  | 9                         |                             |                            |                       | 9            |
| Tgt Acq Radar Vehicle                    |                   |  | 3                         |                             |                            |                       | 3            |
| Chem Recon Vehicle, BRDM-2RKh/RKhM       |                   |  |                           | 3                           |                            |                       | 3            |
| <b>WEAPONS</b>                           |                   |  |                           |                             |                            |                       |              |
| SAM, SA-4/GANEF TEL                      |                   |  | 27                        |                             |                            |                       | 27           |
| SAM, Shoulder-Fired*                     | 3                 |  |                           |                             |                            |                       | 3            |
| 23-mm AA Gun, ZU-23                      |                   |  | 24                        |                             |                            |                       | 24           |
| <b>TRUCKS</b>                            |                   |  |                           |                             |                            |                       |              |
| Truck, Utility                           | 1                 | 2  | 9                         |                             | 3                          | 1                     | 16           |
| Truck, Light                             | 3                 | 1  | 24                        |                             | 2                          | 1                     | 31           |
| Truck, Medium                            |                   |  | 12                        |                             | 25                         | 3                     | 40           |
| Truck, Decon, ARS-12U/14                 |                   |  |                           | 3                           |                            |                       | 3            |
| Truck, Decon, DDA-53/66                  |                   |  |                           | 1                           |                            |                       | 1            |
| Truck, Crane                             |                   |  | 3                         |                             |                            | 1                     | 4            |
| Truck, POL (5,000-L)                     |                   |  | 9                         |                             | 3                          |                       | 12           |
| Truck, Water (2,000-L)                   |                   |  |                           | 2                           | 2                          |                       | 4            |
| Van, Command                             |                   |  | 9                         |                             |                            |                       | 9            |
| Van, Computer                            |                   | 1  |                           |                             |                            |                       | 1            |
| Van, Maintenance                         |                   | 1  | 6                         |                             | 2                          | 8                     | 17           |
| Van, Medium                              | 2                 |  |                           |                             |                            |                       | 2            |
| Van, Radar                               |                   | 1  |                           |                             |                            |                       | 1            |
| Van, Signal                              | 3                 |  | 3                         |                             |                            |                       | 6            |
| Ambulance                                | 2                 |  |                           |                             |                            |                       | 2            |

**FOOTNOTE:**

\* The brigade headquarters may have an AA gun section with two 23-mm AA guns ZU-23, instead of the SAM squad with three shoulder-fired SAMs.

(continued)

**SAM Brigade (SA-4),  
ADC (continued)**

| <i>Principal Items of Equipment</i>        | <i>Brigade HQ</i> | <i>Target Acquisition/Early Warning Btry</i> | <i>SAM Bn (SA-4) (3x)</i> | <i>Chemical Defense Plt</i> | <i>Material Support Co</i> | <i>Maintenance Co</i> | <i>TOTAL</i> |
|--|-------------------|--|---------------------------|-----------------------------|----------------------------|-----------------------|--------------|
| <b>TRAILERS</b>                            |                   |  |                           |                             |                            |                       |              |
| Trailer, Cargo, 1-Axle                     |                   | 1  | 3                         |                             |                            |                       | 4            |
| Trailer, Cargo, 2-Axle                     |                   | 1  | 6                         |                             | 5                          | 3                     | 15           |
| Trailer, Generator                         | 2                 | 3  | 6                         |                             | 2                          | 2                     | 15           |
| Trailer, Kitchen                           | 1                 | 1  | 3                         |                             | 3                          | 1                     | 9            |
| Trailer, POL (4,200-L)                     |                   |  | 9                         |                             | 3                          |                       | 12           |
| Trailer, Van                               | 4                 | 1  | 12                        |                             |                            |                       | 17           |
| Trailer, Water (900-/1,200-L)              |                   |  | 3                         | 2                           | 1                          | 1                     | 7            |
| <b>RADARS</b>                              |                   |  |                           |                             |                            |                       |              |
| Radar, Tgt Acq, LONG TRACK                 |                   | 2  | 3                         |                             |                            |                       | 5            |
| Radar, Fire Control, PAT HAND              |                   |  | 9                         |                             |                            |                       | 9            |
| Radar, Height Finding, THIN SKIN           |                   | 1  |                           |                             |                            |                       | 1            |
| <b>RADIOS</b>                              |                   |  |                           |                             |                            |                       |              |
| VHF, Manpack, Low-Power                    | 1                 | 2  | 27                        |                             | 1                          | 1                     | 32           |
| VHF, Portable, Low-Power                   |                   |  | 9                         |                             |                            |                       | 9            |
| VHF, Portable, Very-Low-Power              | 1                 |  |                           |                             |                            |                       | 1            |
| VHF, Vehicle Mount, Medium-Power           | 1                 | 3  |                           | 3                           |                            |                       | 7            |
| HF, Manpack, Low-Power                     |                   | 2  |                           | 1                           |                            |                       | 3            |
| HF/VHF, Vehicle Mount, Med-Power           | 3                 |  |                           |                             |                            |                       | 3            |
| HF/VHF, Vehicle Mount, High-Power          | 1                 |  |                           |                             |                            |                       | 1            |
| Radio Relay, VHF/UHF                       | 1                 | 1  | 3                         |                             |                            |                       | 5            |
| Warning Receiver                           | 2                 |  | 12                        |                             |                            |                       | 14           |
| <b>MISCELLANEOUS</b>                       |                   |  |                           |                             |                            |                       |              |
| SA-4 Missile Transloader (Medium Truck)    |                   |  | 27                        |                             |                            |                       | 27           |
| SA-4 Missile Transporter (Tractor-Trailer) |                   |  | 9                         |                             |                            |                       | 9            |

SAM Battalion (SA-4),  
SAM Bde (SA-4)

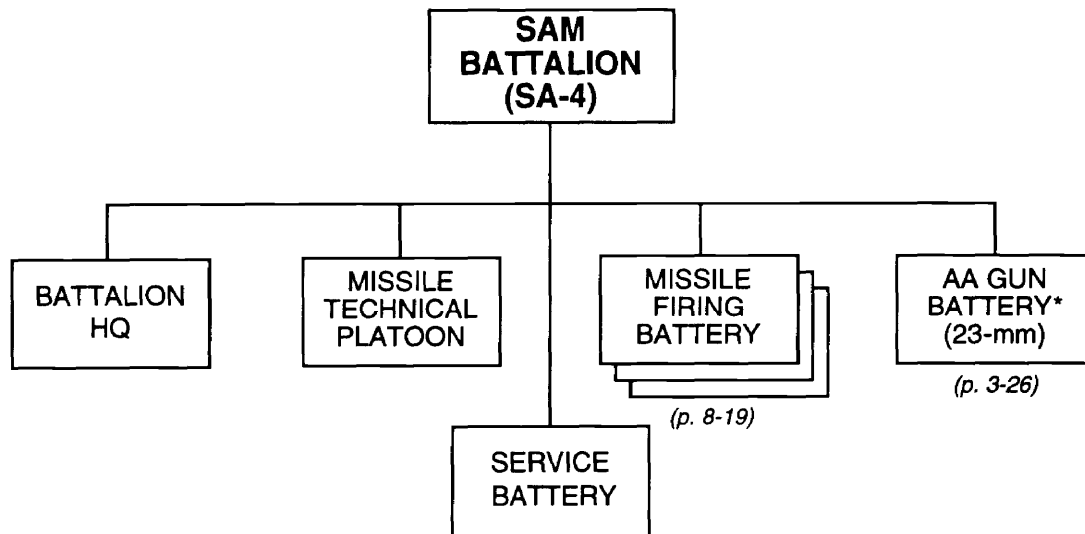

**PRINCIPAL ITEMS OF EQUIPMENT**

| <u>Equipment</u>                       | <u>Total</u> | <u>Equipment</u>                    | <u>Total</u> |
|--|--------------|-------------------------------------|--------------|
| ACV, BTR-60 (PU-12).....               | 4            | Van, Signal.....                    | 1            |
| SAM, SA-4/GANEF TEL.....               | 9            | Trailer, Cargo, 1-Axle.....         | 1            |
| Fire Control Radar Vehicle             |              | Trailer, Cargo, 2-Axle.....         | 2            |
| (TEL Chassis) .....                    | 3            | Trailer, Generator.....             | 2            |
| Target Acquisition Radar Vehicle ..... | 1            | Trailer, Kitchen.....               | 1            |
| SA-4 Missile Transporter               |              | Trailer, POL (4,200-Liter) .....    | 3            |
| (Tractor-Trailer).....                 | 3            | Trailer, Van.....                   | 4            |
| SA-4 Missile Transloader               |              | Trailer, Water(1,200-Liter) .....   | 1            |
| (Medium Truck).....                    | 9            | Radars:                             |              |
| 23-mm AA Gun, ZU-23.....               | 8            | Target Acquisition, LONG TRACK..... | 1            |
| Truck, Utility .....                   | 3            | Fire Control, PAT HAND.....         | 3            |
| Truck, Light .....                     | 8            | Radios:                             |              |
| Truck, Medium .....                    | 4            | VHF, Manpack, Low-Power.....        | 9            |
| Truck, Crane .....                     | 1            | VHF, Portable, Low-Power .....      | 3            |
| Truck, POL (5,000-Liter).....          | 3            | Radio Relay, VHF/UHF.....           | 1            |
| Van, Command.....                      | 3            | Warning Receiver .....              | 4            |
| Van, Maintenance .....                 | 2            |                                     |              |

**FOOTNOTE:** \* If individual missile firing batteries have an AA gun section of two 23-mm AA guns ZU-23, the battalion may also have one AA gun section, instead of an entire AA gun battery.

Missile Firing Battery,  
SAM Bn (SA-4)

---

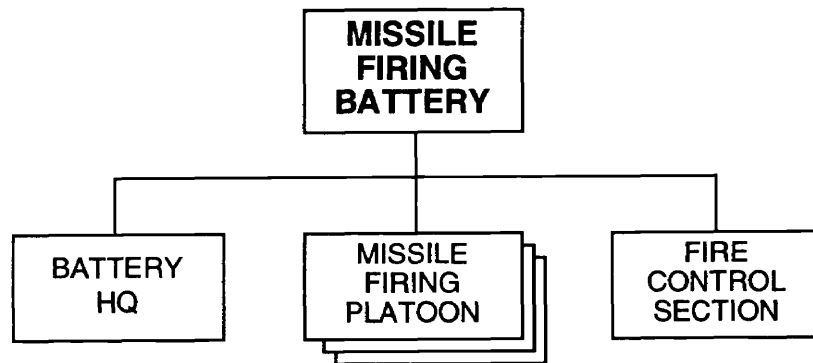

**PRINCIPAL ITEMS OF EQUIPMENT**

| <u>Equipment</u>           | <u>Total</u> | <u>Equipment</u>             | <u>Total</u> |
|----------------------------|--------------|------------------------------|--------------|
| ACV, BTR-60 (PU-12).....   | 1            | Trailer, Van.....            | 1            |
| SAM, SA-4/GANEF TEL.....   | 3            | Radar, Fire Control,         |              |
| SA-4 Missile Transloader   |              | PAT HAND.....                | 1            |
| (Medium Truck).....        | 3            | Radios:                      |              |
| Fire Control Radar Vehicle |              | VHF, Manpack, Low-Power..... | 1            |
| (TEL Chassis).....         | 1            | Warning Receiver.....        | 1            |
| Van, Command.....          | 1            |                              |              |

*NOTE:* Some batteries may have an AA gun section with two 23-mm AA guns ZU-23. In that case, there would be no AA gun battery at battalion level.

SAM Brigade (SA-11),  
ADC

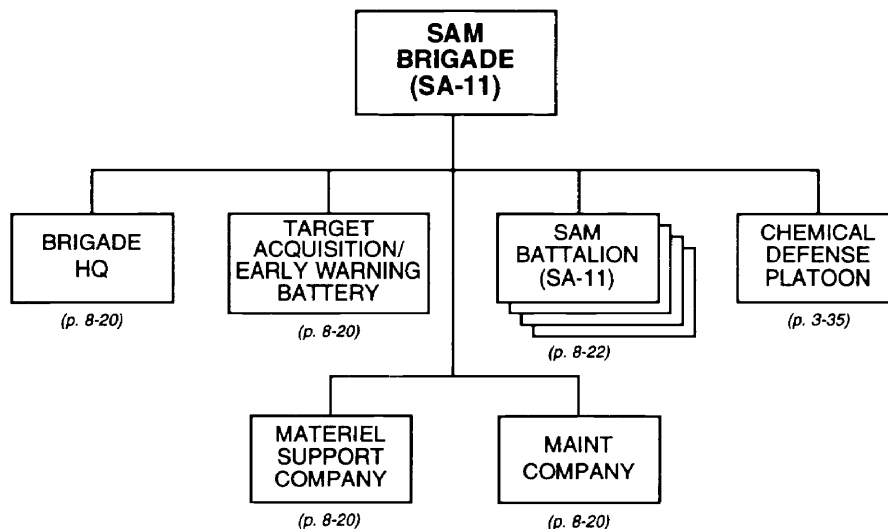

NOTE: SA-11 battalions could combine with other SAM/AA gun units to provide specialized support to a specific region or district.

| <i>Principal Items of Equipment</i> | <i>Brigade HQ</i> | <i>Target Acquisition/Early Warning Btry</i> | <i>SAM Bn (SA-11) (4x)</i> | <i>Chemical Defense Plt</i> | <i>Materiel Support Co</i> | <i>Maintenance Co</i> | <i>TOTAL</i> |
|-------------------------------------|-------------------|--|----------------------------|-----------------------------|----------------------------|-----------------------|--------------|
| <b>ARMORED VEHICLES</b>             |                   |  |                            |                             |                            |                       |              |
| IFV, BMP-1/2                        |                   |  | 12                         |                             |                            |                       | 12           |
| Chem Recon Vehicle, BRDM-2RKh/RKhM  |                   |  |                            | 3                           |                            |                       | 3            |
| <b>WEAPONS</b>                      |                   |  |                            |                             |                            |                       |              |
| SAM, SA-11/GADFLY TELAR*            |                   |  | 24                         |                             |                            |                       | 24           |
| SAM, Shoulder-Fired                 | 3                 |  | 36                         |                             |                            |                       | 39           |
| <b>TRUCKS</b>                       |                   |  |                            |                             |                            |                       |              |
| Truck, Utility                      | 1                 | 2  | 8                          |                             | 3                          | 1                     | 15           |
| Truck, Light                        | 3                 | 1  |                            |                             | 2                          | 1                     | 7            |
| Truck, Medium                       |                   |  | 16                         |                             | 25                         | 3                     | 44           |
| Truck, Decon, ARS-12U/14            |                   |  |                            | 3                           |                            |                       | 3            |
| Truck, Decon, DDA-53/66             |                   |  |                            | 1                           |                            |                       | 1            |
| Truck, Crane                        |                   |  | 4                          |                             |                            | 1                     | 5            |
| Truck, POL (5,000-L)                |                   |  | 8                          |                             | 3                          |                       | 11           |
| Truck, Water (2,000-L)              |                   |  |                            | 2                           | 2                          |                       | 4            |
| Van, Computer                       |                   | 1  |                            |                             |                            |                       | 1            |
| Van, Maintenance                    |                   | 1  |                            |                             | 2                          | 8                     | 11           |
| Van, Medium                         | 2                 |  |                            |                             |                            |                       | 2            |
| Van, Missile Testing                |                   |  | 12                         |                             |                            |                       | 12           |
| Van, Radar                          |                   | 1  |                            |                             |                            |                       | 1            |
| Van, Signal                         | 3                 |  | 4                          |                             |                            |                       | 7            |
| Ambulance                           | 2                 |  |                            |                             |                            |                       | 2            |

FOOTNOTE:

\* This system includes the FIRE DOME fire control radar.

(continued)

SAM Brigade (SA-11 ),  
ADC (continued)

| <i>Principal Items of Equipment</i>         | <i>Brigade HQ</i> | <i>Target Acquisition/Early Warning Btry</i> | <i>SAM Bn (SA-11) (4x)</i> | <i>Chemical Defense Plt</i> | <i>Materiel Support Co</i> | <i>Maintenance Co</i> | <i>TOTAL</i> |
|---|-------------------|--|----------------------------|-----------------------------|----------------------------|-----------------------|--------------|
| <b>TRAILERS</b>                             |                   |  |                            |                             |                            |                       |              |
| Trailer, Cargo, 1-Axle                      |                   | 1  | 4                          |                             |                            |                       | 5            |
| Trailer, Cargo, 2-Axle                      |                   | 1  | 8                          |                             | 5                          | 3                     | 17           |
| Trailer, Generator                          | 2                 | 3  | 8                          |                             | 2                          | 2                     | 17           |
| Trailer, Kitchen                            | 1                 | 1  | 4                          |                             | 3                          | 1                     | 10           |
| Trailer, POL (4,200-L)                      |                   |  |                            |                             | 3                          |                       | 3            |
| Trailer, POL (1,200-L)                      |                   |  | 4                          |                             |                            |                       | 4            |
| Trailer, Van                                | 4                 | 1  | 4                          |                             |                            |                       | 9            |
| Trailer, Water (900-/1,200-L)               |                   |  | 4                          | 2                           | 1                          | 1                     | 8            |
| <b>RADARS</b>                               |                   |  |                            |                             |                            |                       |              |
| Radar, Tgt Acq, SNOW DRIFT or TUBE ARM      |                   |  | 4                          |                             |                            |                       | 4            |
| Radar, Tgt Acq, LONG TRACK                  |                   | 2  |                            |                             |                            |                       | 2            |
| Radar, Height Finding, THIN SKIN            |                   | 1  |                            |                             |                            |                       | 1            |
| <b>RADIOS</b>                               |                   |  |                            |                             |                            |                       |              |
| VHF, Manpack, Low-Power                     | 1                 | 2  | 12                         |                             | 1                          | 1                     | 17           |
| VHF, Portable, Low-Power                    |                   |  | 12                         |                             |                            |                       | 12           |
| VHF, Portable, Very-Low-Power               | 1                 |  | 16                         |                             |                            |                       | 17           |
| VHF, Vehicle Mount, Medium-Power            | 1                 | 3  | 48                         | 3                           |                            |                       | 55           |
| HF, Manpack, Low-Power                      |                   | 2  |                            | 1                           |                            |                       | 3            |
| HF, Vehicle Mount, Medium-Power             | 1                 |  |                            |                             |                            |                       | 1            |
| HF/VHF, Vehicle Mount, Med-Power            | 3                 |  |                            |                             |                            |                       | 3            |
| HF/VHF, Vehicle Mount, High-Power           | 1                 |  |                            |                             |                            |                       | 1            |
| Radio Relay, VHF/UHF                        | 1                 | 1  | 8                          |                             |                            |                       | 10           |
| Warning Receiver                            | 2                 |  | 12                         |                             |                            |                       | 14           |
| <b>MISCELLANEOUS</b>                        |                   |  |                            |                             |                            |                       |              |
| Command Vehicle (TELAR Chassis)             |                   |  | 4                          |                             |                            |                       | 4            |
| Tgt Acq Radar Vehicle (TELAR Chassis)       |                   |  | 4                          |                             |                            |                       | 4            |
| SA-11 Missile Transloader (TELAR Chassis)** |                   |  | 12                         |                             |                            |                       | 12           |
| SA-11 Missile Transporter (Heavy Truck)     |                   |  | 12                         |                             |                            |                       | 12           |

**FOOTNOTE:**

\*\* This system is a combination loader and launcher.



SAM Battalion (SA-11),  
SAM Bde (SA-11)

---

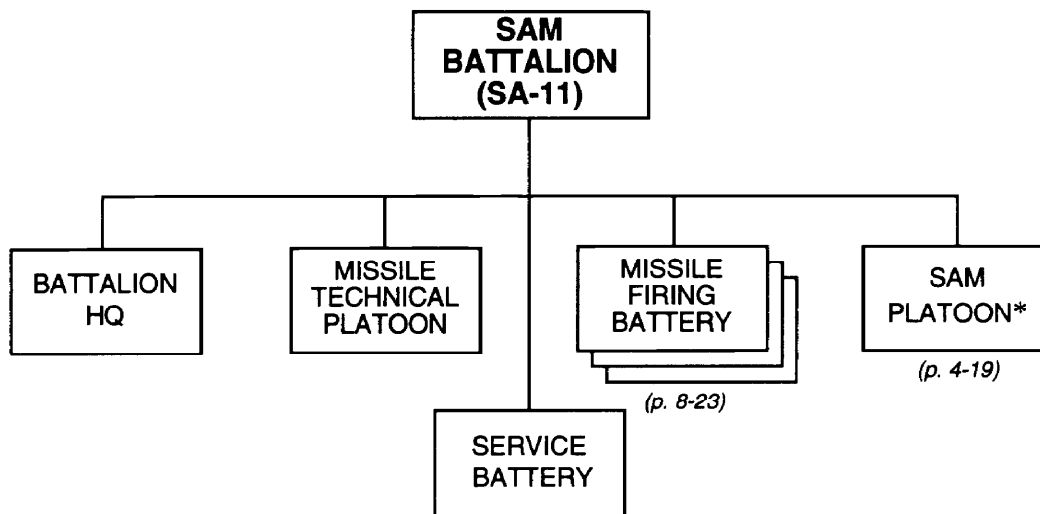

**PRINCIPAL ITEMS OF EQUIPMENT**

| <u>Equipment</u>   | <u>Total</u> | <u>Equipment</u>  | <u>Total</u> |
|--|--------------|---|--------------|
| Command Vehicle (TELAR Chassis).....                     | 1            | Trailer, Cargo, 1-Axle.....                               | 1            |
| SA-11/GADFLY TELAR**.....                                | 6            | Trailer, Cargo, 2-Axle.....                               | 2            |
| Target Acquisition Radar Vehicle<br>(TELAR Chassis)..... | 1            | Trailer, Generator.....                                   | 2            |
| SA-11 Missile Transloader<br>(TELAR Chassis)***.....     | 3            | Trailer, Kitchen.....                                     | 1            |
| SA-11 Missile Transporter<br>(Heavy Truck).....          | 3            | Trailer, POL (1,200-Liter).....                           | 1            |
| SAM, Shoulder-Fired.....                                 | 9            | Trailer, Van.....   | 1            |
| IFV, BMP-1/2.....  | 3            | Trailer, Water(1,200-Liter).....                          | 1            |
| Truck, Utility.....                                      | 2            | Radar, Target Acquisition,<br>SNOW DRIFT or TUBE ARM..... | 1            |
| Truck, Medium.....                                       | 4            | Radios:   |              |
| Truck, Crane.....  | 1            | VHF, Manpack, Low-Power.....                              | 3            |
| Truck, POL (5,000-Liter).....                            | 2            | VHF, Portable, Low-Power.....                             | 3            |
| Van, Maintenance.....                                    | 2            | VHF, Portable, Very-Low-Power.....                        | 4            |
| Van, Missile Testing.....                                | 3            | VHF, Vehicle Mount,<br>Medium Power.....                  | 12           |
| Van, Signal.....   | 1            | Radio Relay, VHF/UHF.....                                 | 2            |
|  |              | Warning Receiver.....                                     | 3            |

**FOOTNOTES:**

\* The battalion commander may retain the entire SAM platoon under his own control, or he may allocate its squads to individual SA-11 missile firing batteries.

\*\* This system includes the FIRE DOME fire control radar.

\*\*\* This system is a combination loader and launcher. (See the third footnote on p. 8-23.)

Missile Firing Battery,  
SAM Bn (SA-11)

---

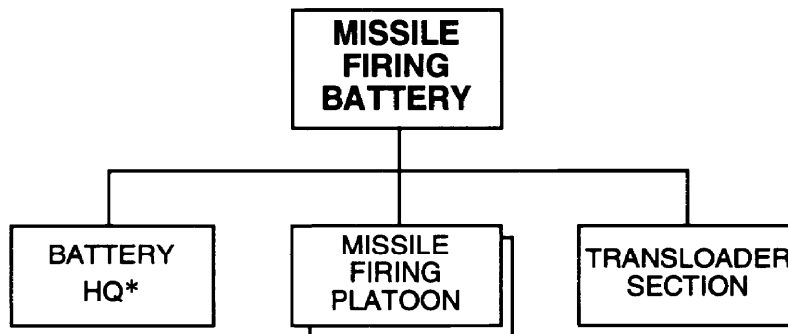

**PRINCIPAL ITEMS OF EQUIPMENT**

| <u>Equipment</u>                                      | <u>Total</u> | <u>Equipment</u>                          | <u>Total</u> |
|---|--------------|---|--------------|
| SAM, SA-11/GADFLY TELAR** .....                       | 2            | Radios:                                   |              |
| SA-11 Missile Transloader<br>(TELAR Chassis)*** ..... | 1            | VHF, Vehicle Mount,<br>Medium-Power ..... | 3            |
|   |              | Warning Receiver .....                    | 1            |

**FOOTNOTES:**

- \* The battery commander controls the battery from one of the TELARs.
- \*\* This system includes the FIRE DOME fire control radar.
- \*\*\* This system is a combination loader and launcher. This vehicle has the same four-rail launcher as the TELAR, but has no onboard fire control radar. It carries four missiles on launch rails, ready to fire, and four missiles for reloading its own launcher or a TELAR.

SAM Regiment (SA-8),  
ADC

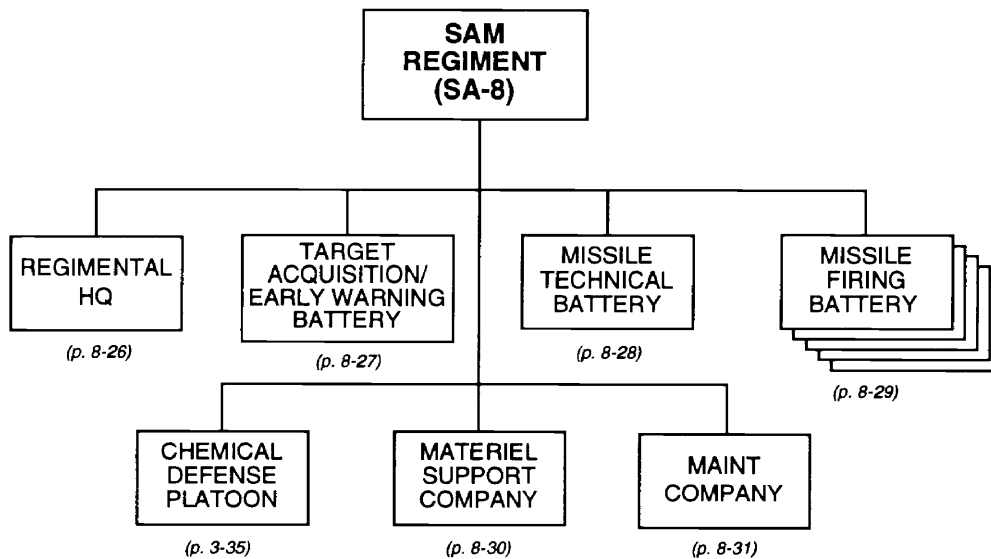

| <i>Principal Items of Equipment</i>    | <i>Regimental HQ</i> | <i>Target Acquisition/Early Warning Btry</i> | <i>Missile Tech Btry</i> | <i>Missile Firing Btry (5x)</i> | <i>Chem Defense Plt</i> | <i>Materiel Support Co</i> | <i>Maintenance Co</i> | <i>TOTAL</i> |
|--|----------------------|--|--------------------------|---------------------------------|-------------------------|----------------------------|-----------------------|--------------|
| <b>ARMORED VEHICLES</b>                |                      |  |                          |                                 |                         |                            |                       |              |
| Chemical Recon Vehicle, BRDM-2RKh/RKhM |                      |  |                          |                                 | 3                       |                            |                       | 3            |
| ACV, BTR-60 (PU-12)                    | 1                    |  |                          | 5                               |                         |                            |                       | 6            |
| Tgt Acq Radar Vehicle                  |                      | 2  |                          |                                 |                         |                            |                       | 2            |
| <b>WEAPONS</b>                         |                      |  |                          |                                 |                         |                            |                       |              |
| SAM, SA-8/GECKO*                       |                      |  |                          | 20                              |                         |                            |                       | 20           |
| SAM, Shoulder-Fired                    | 3                    |  | 3                        | 15                              |                         |                            |                       | 21           |
| <b>TRUCKS</b>                          |                      |  |                          |                                 |                         |                            |                       |              |
| Truck, Utility                         | 1                    | 3  | 1                        |                                 |                         | 1                          | 1                     | 7            |
| Truck, Light                           | 3                    | 1  | 6                        | 5                               |                         | 1                          | 3                     | 19           |
| Truck, Medium                          |                      |  | 4                        |                                 |                         | 22                         | 3                     | 29           |
| Truck, Decon, ARS-12U/14               |                      |  |                          |                                 | 3                       |                            |                       | 3            |
| Truck, Decon, DDA-53/66                |                      |  |                          |                                 | 1                       |                            |                       | 1            |
| Truck, Crane                           |                      |  | 2                        |                                 |                         |                            |                       | 2            |
| Truck, POL (5,000-L)                   |                      |  |                          |                                 |                         | 6                          |                       | 6            |
| Truck, Water (2,000-L)                 |                      |  |                          |                                 | 2                       |                            |                       | 2            |
| Van, Computer                          |                      | 1  |                          |                                 |                         |                            |                       | 1            |
| Van, Maintenance                       |                      | 1  |                          |                                 |                         | 3                          | 8                     | 12           |
| Van, Medium                            | 2                    |  |                          | 5                               |                         | 4                          |                       | 11           |
| Van, Missile Testing                   |                      |  | 5                        |                                 |                         |                            |                       | 5            |
| Van, Radar                             |                      | 1  |                          |                                 |                         |                            |                       | 1            |
| Van, Signal                            | 4                    |  |                          |                                 |                         |                            |                       | 4            |
| Ambulance                              | 2                    |  |                          |                                 |                         |                            |                       | 2            |

**FOOTNOTE:**

\* This system includes the LAND ROLL fire control/target acquisition radar.

(continued)

SAM Regiment (SA-8),  
ADC (continued)

| <i>Principal Items of Equipment</i>  | <i>Regimental HQ</i> | <i>Target Acquisition/Early Warning Btry</i> | <i>Missile Tech Btry</i> | <i>Missile Firing Btry (5x)</i> | <i>Chem Defense Plt</i> | <i>Material Support Co</i> | <i>Maintenance Co</i> | <i>TOTAL</i> |
|--------------------------------------|----------------------|--|--------------------------|---------------------------------|-------------------------|----------------------------|-----------------------|--------------|
| <b>TRAILERS</b>                      |                      |  |                          |                                 |                         |                            |                       |              |
| Trailer, Cargo, 2-Axe                |                      | 1  | 1                        | 5                               |                         | 5                          | 3                     | 15           |
| Trailer, Generator                   | 2                    | 1  | 1                        |                                 |                         | 3                          | 7                     | 13           |
| Trailer, Kitchen                     | 1                    | 1  | 2                        | 5                               |                         | 1                          | 1                     | 11           |
| Trailer, POL (4,200-L)               |                      |  |                          |                                 |                         | 6                          |                       | 6            |
| Trailer, POL (1,200-L)               |                      |  |                          |                                 |                         | 2                          |                       | 2            |
| Trailer, Van                         | 4                    | 1  | 1                        | 5                               |                         | 2                          |                       | 13           |
| Trailer, Water (1,200-L)             |                      |  |                          |                                 | 2                       | 3                          | 1                     | 6            |
| <b>RADARS</b>                        |                      |  |                          |                                 |                         |                            |                       |              |
| Radar, Aer. Surv/Tgt Acq, LONG TRACK |                      | 2  |                          |                                 |                         |                            |                       | 2            |
| Radar, Height Finding, THIN SKIN     |                      | 1  |                          |                                 |                         |                            |                       | 1            |
| <b>RADIOS</b>                        |                      |  |                          |                                 |                         |                            |                       |              |
| VHF, Manpack, Low-Power              | 1                    | 2  | 1                        | 5                               |                         | 1                          | 1                     | 11           |
| VHF, Portable, Low-Power             |                      |  | 3                        |                                 |                         |                            |                       | 3            |
| VHF, Portable, Very-Low-Power        | 1                    |  | 1                        | 5                               |                         |                            |                       | 7            |
| VHF, Vehicle Mount, Medium-Power     | 1                    | 3  |                          | 30                              | 3                       |                            |                       | 37           |
| HF, Manpack, Low-Power               |                      | 2  |                          |                                 | 1                       |                            |                       | 3            |
| HF/VHF, Vehicle Mount, Med-Power     | 4                    |  |                          |                                 |                         |                            |                       | 4            |
| HF/VHF, Vehicle Mount, High-Power    | 2                    |  |                          |                                 |                         |                            |                       | 2            |
| Radio Relay, VHF/UHF                 | 1                    |  |                          |                                 |                         |                            |                       | 1            |
| Warning Receiver                     | 2                    |  |                          | 5                               |                         |                            |                       | 7            |
| <b>MISCELLANEOUS</b>                 |                      |  |                          |                                 |                         |                            |                       |              |
| SA-8 Transloader (TELAR Chassis)     |                      |  |                          | 10                              |                         |                            |                       | 10           |

**Regimental Headquarters, SAM Regt  
or Air Defense Regt**

---

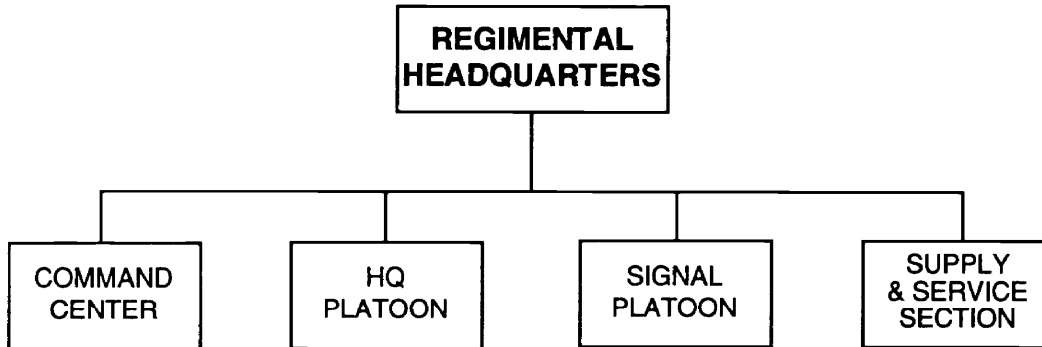

**PRINCIPAL ITEMS OF EQUIPMENT**

| <u>Equipment</u>         | <u>Total</u> |
|--------------------------|--------------|
| SAM, Shoulder-Fired..... | 3            |
| ACV, BTR-60 (PU-12)..... | 1            |
| Truck, Utility .....     | 1            |
| Truck, Light .....       | 3            |
| Van, Medium .....        | 2            |
| Van, Signal.....         | 4            |
| Ambulance .....          | 2            |
| Trailer, Generator.....  | 2            |
| Trailer, Kitchen .....   | 1            |
| Trailer, Van.....        | 4            |

| <u>Equipment</u>                             | <u>Total</u> |
|--|--------------|
| <b>Radios:</b>                               |              |
| VHF, Manpack, Low-Power.....                 | 1            |
| VHF, Portable, Very-Low-Power .....          | 1            |
| VHF, Vehicle Mount,<br>Medium-Power .....    | 1            |
| HF/VHF, Vehicle Mount,<br>Medium-Power ..... | 4            |
| HF/VHF, Vehicle Mount,<br>High-Power .....   | 2            |
| Radio Relay, VHF/UHF.....                    | 1            |
| Warning Receiver .....                       | 2            |

**Target Acquisition/Early Warning Battery,  
SAM Regt or Air Defense Regt**

---

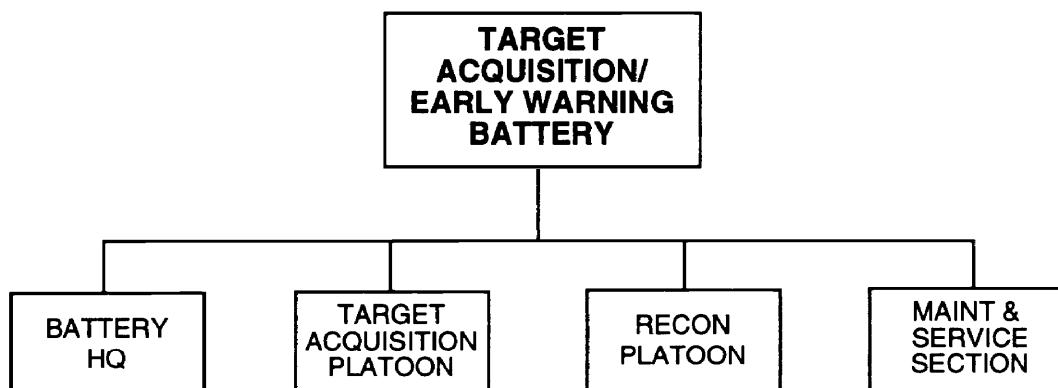

**PRINCIPAL ITEMS OF EQUIPMENT**

| <u>Equipment</u>                       | <u>Total</u> |
|--|--------------|
| Target Acquisition Radar Vehicle ..... | 2            |
| Truck, Utility .....                   | 3            |
| Truck, Light .....                     | 1            |
| Van, Computer.....                     | 1            |
| Van, Maintenance .....                 | 1            |
| Van, Radar .....                       | 1            |
| Trailer, Cargo, 2-Axle.....            | 1            |
| Trailer, Kitchen.....                  | 1            |
| Trailer, Van.....                      | 1            |

| <u>Equipment</u>                | <u>Total</u> |
|---------------------------------|--------------|
| <b>Radars:</b>                  |              |
| Aerial Surveillance/Target      |              |
| Acquisition, LONG TRACK .....   | 2            |
| Height Finding, THIN SKIN ..... | 1            |
| <b>Radios:</b>                  |              |
| VHF, Manpack, Low-Power.....    | 2            |
| VHF, Vehicle Mount,             |              |
| Medium-Power .....              | 3            |
| HF, Manpack, Low-Power.....     | 2            |

Missile Technical Battery,  
SAM Regt (SA-8)

---

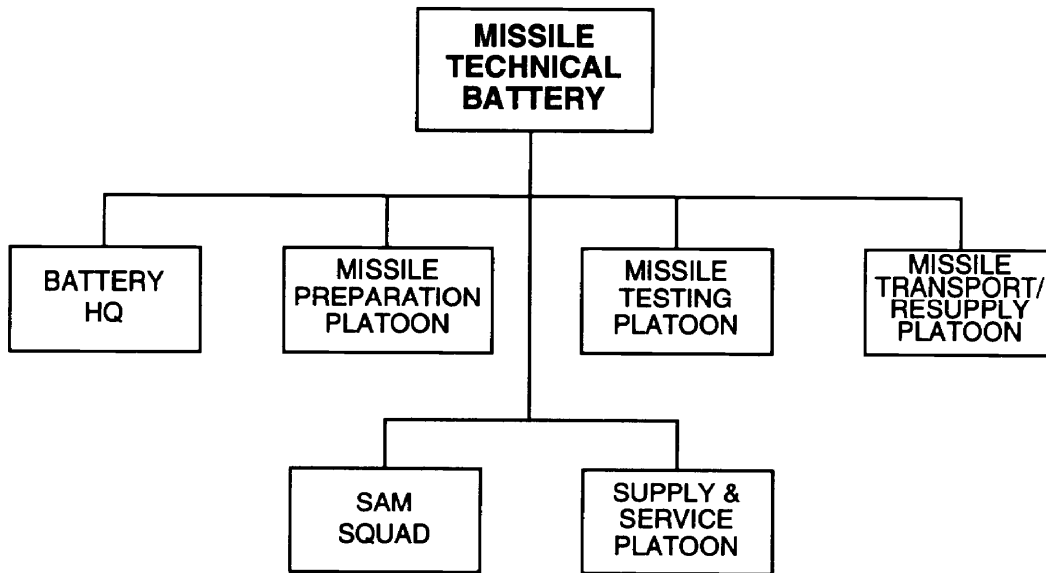

(p. 2-23)

**PRINCIPAL ITEMS OF EQUIPMENT**

| <u>Equipment</u>            | <u>Total</u> |
|-----------------------------|--------------|
| SAM, Shoulder-Fired.....    | 3            |
| Truck, Utility .....        | 1            |
| Truck, Light .....          | 6            |
| Truck, Medium .....         | 4            |
| Truck, Crane .....          | 2            |
| Van, Missile Testing .....  | 5            |
| Trailer, Cargo, 2-Axle..... | 1            |

| <u>Equipment</u>                    | <u>Total</u> |
|-------------------------------------|--------------|
| Trailer, Generator.....             | 1            |
| Trailer, Kitchen.....               | 2            |
| Trailer, Van.....                   | 1            |
| Radios:                             |              |
| VHF, Manpack, Low-Power.....        | 1            |
| VHF, Portable, Low-Power .....      | 3            |
| VHF, Portable, Very-Low-Power ..... | 1            |

**Missile Firing Battery, SAM Regt (SA-8)  
or SAM Bn (SA-8), Air Defense Regt**

---

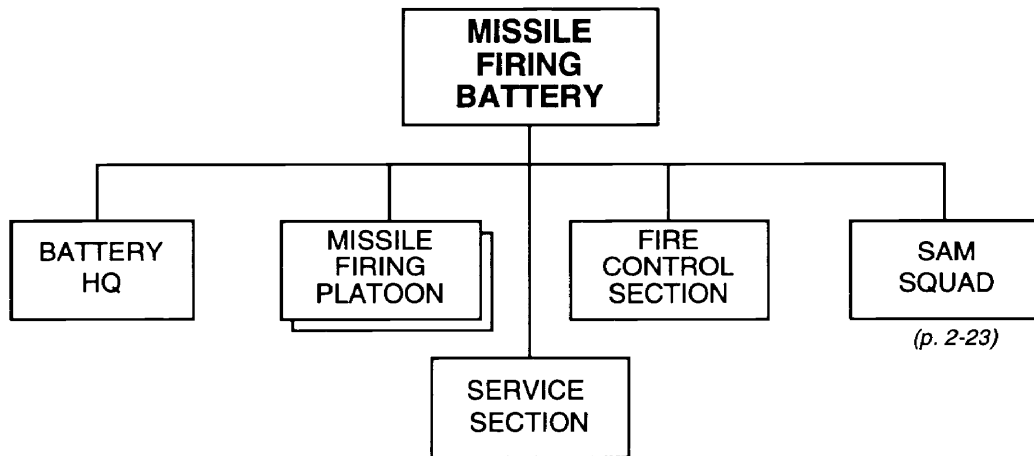

**PRINCIPAL ITEMS OF EQUIPMENT**

| <u>Equipment</u>            | <u>Total</u> | <u>Equipment</u>                   | <u>Total</u> |
|-----------------------------|--------------|------------------------------------|--------------|
| ACV, BTR-60 (PU-12).....    | 1            | Trailer, Kitchen.....              | 1            |
| SAM, SA-8/GECKO TELAR*..... | 4            | Trailer, Van.....                  | 1            |
| SA-8 Missile Transloader    |              | Radios:                            |              |
| (TELAR Chassis).....        | 2            | VHF, Manpack, Low-Power.....       | 1            |
| SAM, Shoulder-Fired.....    | 3            | VHF, Portable, Very-Low-Power..... | 1            |
| Truck, Light.....           | 1            | VHF, Vehicle Mount,                |              |
| Van, Medium.....            | 1            | Medium-Power.....                  | 6            |
| Trailer, Cargo, 2-Axle..... | 1            | Warning Receiver.....              | 1            |

*NOTE:* \* The TELAR includes the LAND ROLL fire control/target acquisition radar.



**Materiel Support Company,  
SAM Regt**

---

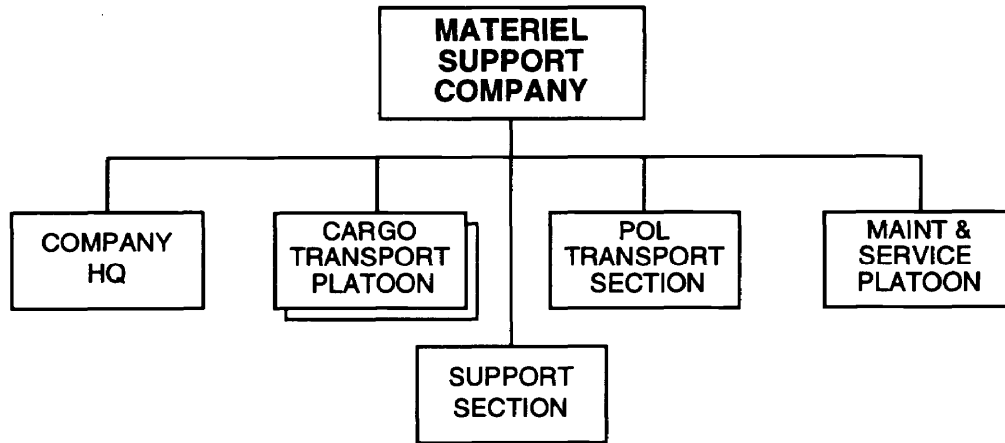

**PRINCIPAL ITEMS OF EQUIPMENT**

| <u>Equipment</u>              | <u>Total</u> | <u>Equipment</u>                     | <u>Total</u> |
|-------------------------------|--------------|--------------------------------------|--------------|
| Truck, Utility .....          | 1            | Trailer, Generator.....              | 3            |
| Truck, Light .....            | 1            | Trailer, Kitchen.....                | 1            |
| Truck, Medium .....           | 22           | Trailer, POL (1,200-Liter) .....     | 2            |
| Truck, POL (5,000-Liter)..... | 6            | Trailer, POL (4,200-Liter) .....     | 6            |
| Van, Maintenance .....        | 3            | Trailer, Van.....                    | 2            |
| Van, Medium .....             | 4            | Trailer, Water (1,200-Liter) .....   | 3            |
| Trailer, Cargo, 2-Axle.....   | 5            | Radio, VHF, Manpack, Low-Power ..... | 1            |

Maintenance Company, SAM Regt  
or Air Defense Regt \_\_\_\_\_

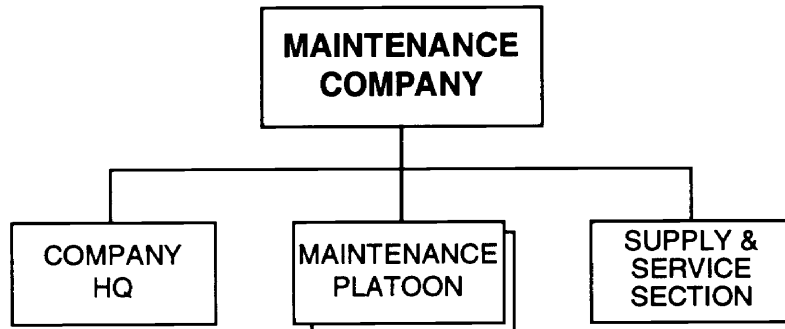

**PRINCIPAL ITEMS OF EQUIPMENT**

| <u>Equipment</u>             | <u>Total</u> | <u>Equipment</u>                     | <u>Total</u> |
|------------------------------|--------------|--------------------------------------|--------------|
| Truck, Utility .....         | 1            | Trailer, Generator .....             | 7            |
| Truck, Light .....           | 3            | Trailer, Kitchen .....               | 1            |
| Truck, Medium .....          | 3            | Trailer, Water (1,200-Liter) .....   | 1            |
| Van, Maintenance .....       | 8            | Radio, VHF, Manpack, Low-Power ..... | 1            |
| Trailer, Cargo, 2-Axle ..... | 3            |                                      |              |

SAM Regiment (SA-6),  
ADC

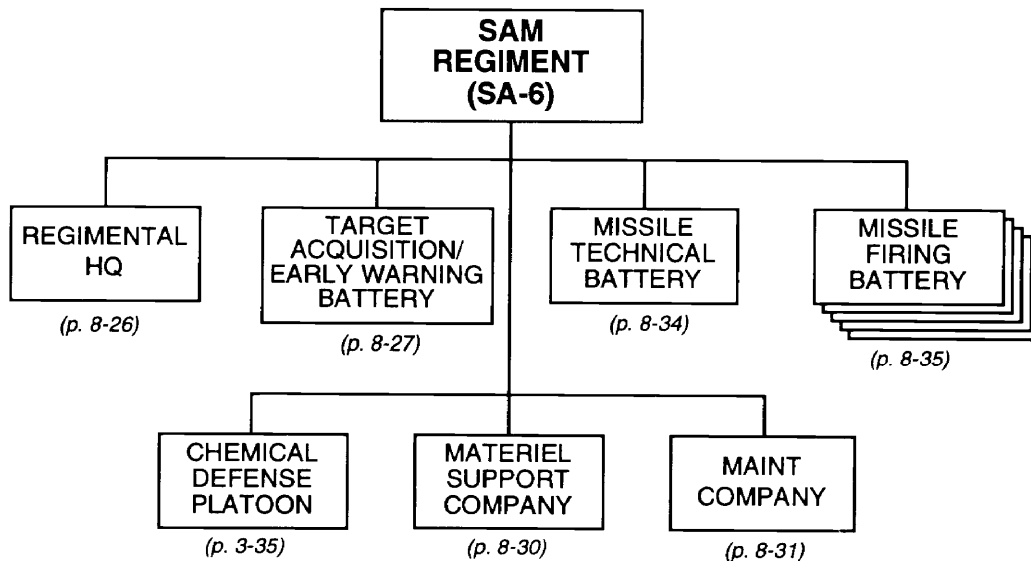

| <i>Principal Items of Equipment</i>    | <i>Regimental HQ</i> | <i>Target Acquisition/Early Warning Btry</i> | <i>Missile Tech Btry</i> | <i>Missile Firing Btry (5x)</i> | <i>Chem Defense Plt</i> | <i>Materiel Support Co</i> | <i>Maintenance Co</i> | <i>TOTAL</i> |
|--|----------------------|--|--------------------------|---------------------------------|-------------------------|----------------------------|-----------------------|--------------|
| <b>ARMORED VEHICLES</b>                |                      |  |                          |                                 |                         |                            |                       |              |
| ACV, BRDM-2U                           |                      |  |                          | 5                               |                         |                            |                       | 5            |
| Chemical Recon Vehicle, BRDM-2RKh/RKhM |                      |  |                          |                                 | 3                       |                            |                       | 3            |
| ACV, BTR-60 (PU-12)                    | 1                    |  |                          |                                 |                         |                            |                       | 1            |
| Tgt Acq Radar Vehicle                  |                      | 2  |                          |                                 |                         |                            |                       | 2            |
| <b>WEAPONS</b>                         |                      |  |                          |                                 |                         |                            |                       |              |
| SAM, SA-6/GAINFUL                      |                      |  |                          | 20                              |                         |                            |                       | 20           |
| SAM, Shoulder-Fired                    | 3                    |  | 3                        | 15                              |                         |                            |                       | 21           |
| <b>TRUCKS</b>                          |                      |  |                          |                                 |                         |                            |                       |              |
| Truck, Utility                         | 1                    | 3  | 1                        |                                 |                         | 1                          | 1                     | 7            |
| Truck, Light                           | 3                    | 1  | 6                        | 5                               |                         | 1                          | 3                     | 19           |
| Truck, Medium                          |                      |  | 5                        |                                 |                         | 22                         | 3                     | 30           |
| Truck, Decon, ARS-12U/14               |                      |  |                          |                                 | 3                       |                            |                       | 3            |
| Truck, Decon, DDA-53/66                |                      |  |                          |                                 | 1                       |                            |                       | 1            |
| Truck, Crane                           |                      |  | 2                        |                                 |                         |                            |                       | 2            |
| Truck, POL (5,000-L)                   |                      |  |                          |                                 |                         | 6                          |                       | 6            |
| Truck, Water (2,000-L)                 |                      |  |                          |                                 | 2                       |                            |                       | 2            |
| Van, Computer                          |                      | 1  |                          |                                 |                         |                            |                       | 1            |
| Van, Maintenance                       |                      | 1  |                          |                                 |                         | 3                          | 8                     | 12           |
| Van, Medium                            | 2                    |  |                          | 5                               |                         | 4                          |                       | 11           |
| Van, Missile Testing                   |                      |  | 5                        |                                 |                         |                            |                       | 5            |
| Van, Radar                             |                      | 1  |                          |                                 |                         |                            |                       | 1            |
| Van, Signal                            | 4                    |  |                          |                                 |                         |                            |                       | 4            |
| Ambulance                              | 2                    |  |                          |                                 |                         |                            |                       | 2            |

(continued)

**SAM Regiment (SA-6),  
ADC (continued)**

| <i>Principal Items of<br/>Equipment</i>     | <i>Regimental HQ</i> | <i>Target Acquisition/Early<br/>Warning Btry</i> | <i>Missile Tech Btry</i> | <i>Missile Firing Btry (5x)</i> | <i>Chem Defense Plt</i> | <i>Materiel Support Co</i> | <i>Maintenance Co</i> | <i>TOTAL</i> |
|---|----------------------|--|--------------------------|---------------------------------|-------------------------|----------------------------|-----------------------|--------------|
| <b>TRAILERS</b>                             |                      |  |                          |                                 |                         |                            |                       |              |
| Trailer, Cargo, 2-Axle                      |                      | 1  | 1                        | 5                               |                         | 5                          | 3                     | 15           |
| Trailer, Generator                          | 2                    |  | 1                        |                                 |                         | 3                          | 7                     | 13           |
| Trailer, Kitchen                            | 1                    | 1  | 2                        | 5                               |                         | 1                          | 1                     | 11           |
| Trailer, POL (4,200-L)                      |                      |  |                          |                                 |                         | 6                          |                       | 6            |
| Trailer, POL (1,200-L)                      |                      |  |                          |                                 |                         | 2                          |                       | 2            |
| Trailer, Van                                | 4                    | 1  | 1                        | 5                               |                         | 2                          |                       | 13           |
| Trailer, Water (1,200-L)                    |                      |  |                          |                                 | 2                       | 3                          | 1                     | 6            |
| <b>RADARS</b>                               |                      |  |                          |                                 |                         |                            |                       |              |
| Radar, Aer. Surv/Tgt Acq, LONG TRACK        |                      | 2  |                          |                                 |                         |                            |                       | 2            |
| Radar, Fire Control, STRAIGHT FLUSH         |                      |  |                          | 5                               |                         |                            |                       | 5            |
| Radar, Height Finding, THIN SKIN            |                      | 1  |                          |                                 |                         |                            |                       | 1            |
| <b>RADIOS</b>                               |                      |  |                          |                                 |                         |                            |                       |              |
| VHF, Manpack, Low-Power                     | 1                    | 2  | 1                        | 5                               |                         | 1                          | 1                     | 11           |
| VHF, Portable, Low-Power                    |                      |  | 3                        |                                 |                         |                            |                       | 3            |
| VHF, Portable, Very-Low-Power               | 1                    |  | 1                        | 5                               |                         |                            |                       | 7            |
| VHF, Vehicle Mount, Medium-Power            | 1                    | 3  |                          | 30                              | 3                       |                            |                       | 37           |
| HF, Manpack, Low-Power                      |                      | 2  |                          |                                 | 1                       |                            |                       | 3            |
| HF/VHF, Vehicle Mount, Med-Power            | 4                    |  |                          |                                 |                         |                            |                       | 4            |
| HF/VHF, Vehicle Mount, High-Power           | 2                    |  |                          |                                 |                         |                            |                       | 2            |
| Radio Relay, VHF/UHF                        | 1                    |  |                          |                                 |                         |                            |                       | 1            |
| Warning Receiver                            | 2                    |  |                          | 5                               |                         |                            |                       | 7            |
| <b>MISCELLANEOUS</b>                        |                      |  |                          |                                 |                         |                            |                       |              |
| Fire Control Radar Vehicle (TELAR Chassis)  |                      |  | 5                        | 5                               |                         |                            |                       | 10           |
| SA-6 Canister Transporter (Tractor-Trailer) |                      |  | 15                       |                                 |                         |                            |                       | 15           |
| SA-6 Missile Transloader (Medium Truck)     |                      |  | 5                        | 10                              |                         |                            |                       | 15           |

Missile Technical Battery,  
SAM Regt (SA-6)

---

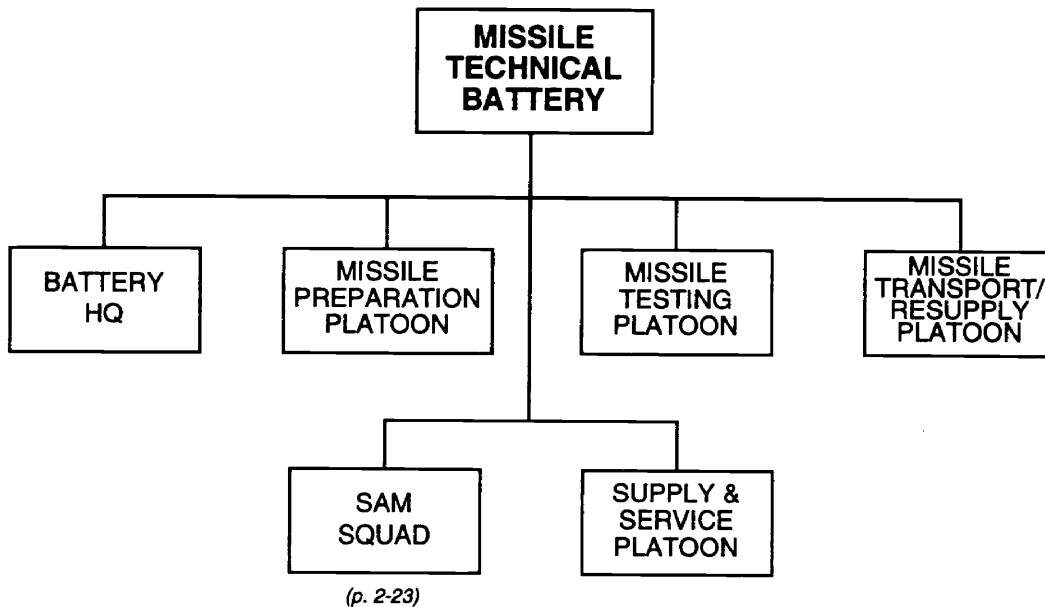

**PRINCIPAL ITEMS OF EQUIPMENT**

| <u>Equipment</u>                                    | <u>Total</u> |
|---|--------------|
| SAM, Shoulder-Fired.....                            | 3            |
| Truck, Utility .....                                | 1            |
| Truck, Light .....                                  | 6            |
| Truck, Medium .....                                 | 5            |
| Truck, Crane .....                                  | 2            |
| Van, Missile Testing.....                           | 5            |
| SA-6 Canister Transporter<br>(Tractor-Trailer)..... | 15           |
| SA-6 Missile Transloader<br>(Medium Truck).....     | 5            |

| <u>Equipment</u>                    | <u>Total</u> |
|-------------------------------------|--------------|
| Trailer, Cargo, 2-Axle.....         | 1            |
| Trailer, Generator.....             | 1            |
| Trailer, Kitchen.....               | 2            |
| Trailer, Van.....                   | 1            |
| Radios:                             |              |
| VHF, Manpack, Low-Power.....        | 1            |
| VHF, Portable, Low-Power .....      | 3            |
| VHF, Portable, Very-Low-Power ..... | 1            |

Missile Firing Battery,  
SAM Regt (SA-6)

---

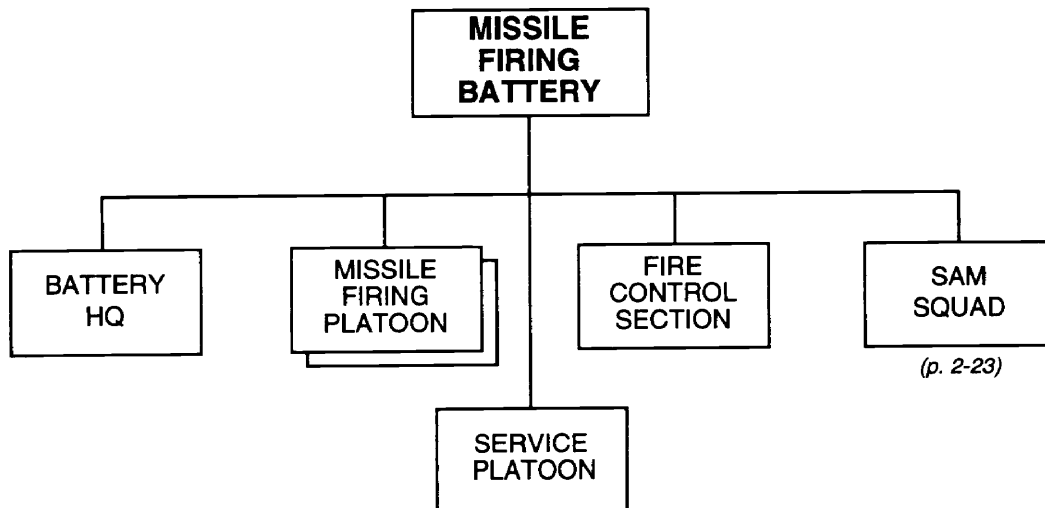

**PRINCIPAL ITEMS OF EQUIPMENT**

| <u>Equipment</u>  | <u>Total</u> | <u>Equipment</u>                          | <u>Total</u> |
|---|--------------|---|--------------|
| ACV, BRDM-2U .....                                      | 1            | Trailer, Cargo, 2-Axle .....              | 1            |
| SAM, SA-6a/GAINFUL TEL or<br>SA-6b/GAINFUL TELAR* ..... | 4            | Trailer, Kitchen .....                    | 1            |
| Fire Control Radar Vehicle<br>(TELAR Chassis) .....     | 1            | Trailer, Van .....                        | 1            |
| SA-6 Missile Transloader<br>(Medium Truck) .....        | 2            | Radar, Fire Control, STRAIGHT FLUSH ...   | 1            |
| SAM, Shoulder-Fired .....                               | 3            | Radios:                                   |              |
| Truck, Light .....                                      | 1            | VHF, Manpack, Low-Power .....             | 1            |
| Van, Medium .....                                       | 1            | VHF, Portable, Very-Low-Power .....       | 1            |
|   |              | VHF, Vehicle Mount,<br>Medium-Power ..... | 6            |
|   |              | Warning Receiver .....                    | 1            |

**FOOTNOTE:** \* The SA-6b system includes the FIRE DOME fire control radar.

## Appendix A

### Maneuver and Fire Support Equipment Substitution Matrices

The matrices in this appendix illustrate some of the different equipment options available to scenario and order of battle developers. Although this organization guide provides a baseline of widely-used systems produced in the former Soviet Union (FSU), the intent of the capabilities-based OPFOR is to allow users to tailor their orders of battle by substituting other worldwide systems. Deviations from the baseline systems should relate to specific training objectives. For example, users may seek to mirror the actual mix of equipment found in a particular region or to introduce a particular weapons capability or vulnerability.

The matrices list most of the major **baseline** systems in the organization guide and provide a number of potential substitutes for each. While the lists of **potential substitutes** are not all-inclusive, they contain most common systems that have roughly **comparable** capabilities. They also contain some **alternative** systems that may perform the same missions (with greater or lesser capability) or have different capabilities for special uses. Entries may include system name, caliber of main armament, vehicle mount (for self-propelled systems), and digraph for country of origin. Entries within the alternative category also include one of the following symbols identifying each system's capabilities in relation to the baseline:

- (+) More capable.
- (-) Less capable.
- (\*) Different capabilities for special uses.

Users substituting systems from the matrices or considering other foreign weapons systems for use in an OPFOR order of battle should evaluate candidate substitutes against the following criteria

- **Is the system available to potential adversaries?** To satisfy this criterion, the system should be in service with the armed forces of countries traditionally hostile to the United States or widely exported on the world market.
- **Does the system exist in large enough quantities to justify training against it?** At a minimum, total system production should at least equal the numbers contained in a proposed order of battle. Moreover, US military units using currently available equipment generally should not train against foreign developmental systems that have not reached initial operational capability (IOC).
- **Does the mix and variety of systems in an order of battle conform to some logical pattern?** Some users constructing a large order of battle may want to pattern the mix of system types and generations on some actual country. Others may wish to standardize systems throughout the order of battle for simplicity or ease in modeling. In any case, the systems portrayed generally should be in unit sets of regimental or battalion size. Because of the logistics and training challenges involved in supporting a weapon system, users should avoid excessive variety.

Users should keep in mind that substitutions for major weapons systems may also affect the types and numbers of supporting systems.

Medium Tank Substitution Matrix

| Baseline Systems  | Potential Substitutes  |   |
|---|--|---|
|   | Comparable   | Alternative   |
| T-55 (100-mm RS)<br>T-62 (115-mm RS)  | T-55AM2B (100-mm RS)<br>T-62M (115-mm RS)<br>Centurion (105-mm UK)<br>AMX-30 (105-mm FR)<br>Type 59 (100-mm CH)<br>Type 69 IIM (105-mm CH)<br>M-60A1/3 (105-mm US) | PT-76 Light Tank (76-mm RS)(*)<br>T-34 (85-mm RS)(-)<br>Type 63 Light Tank (85-mm CH)(*)<br>ASU-85 Assault Gun (85-mm RS)(-)<br>M41 Light Tank (90-mm US)(*)<br>SU-100 Assault Gun (100-mm RS)(-)<br>T-72 (125-mm RS) (+)<br>T-80 (125-mm RS) (+) |
| KEY: (+) More capable. (-) Less capable. (*) Different capabilities for special uses. |  |   |



Light Armored Vehicle Substitution Matrix \_\_\_\_\_

| Baseline Systems   | Potential Substitutes   |   |
|--|---|---|
|  | Comparable  | Alternative   |
| Infantry Fighting Vehicle<br>BMP-2 (30-mm RS)<br><br>BMP-1 (73-mm RS)                                  | Warrior (30-mm UK)<br><br>Marder 1A3 (20-mm GM)<br><br>BVP M80A (20-mm SR)<br><br>AMX-10P (20-mm FR)          | BMP-3 (30/100-mm RS)(+)<br><br>BMD-1 (73-mm RS)(*)  |
| Armored Scout Car<br>BRDM-2 (14.5-mm RS)   | BRDM-1 (7.62-mm RS)<br><br>V-150 Commando<br>(7.62-mm US)<br><br>EE-3 (12.7-mm BR)                            | Alvis Fox (20-mm UK)(+)<br><br>Shorlund S52 (7.62-mm UK)(*)<br><br>Wiesel-25 (25-mm GM)(+)  |
| Armored Command Vehicle<br>BRM-1K (73-mm RS)   | Scorpion (76/90-mm UK)<br><br>AMX-10 PAC-90 (90-mm FR)<br><br>EE-9/Cascavel (90-mm BR)                        | Mobile Recon Post PRP-3/4<br>(7.62-mm RS)(*)<br><br>AMX-10 RAC (105-mm FR)(+)   |
| Armored Personnel Carrier<br>BTR-80 (14.5-mm RS)<br><br>BTR-70 (14.5-mm RS)<br><br>BTR-60 (14.5-mm RS) | VAB (12.7-mm FR)<br><br>V-300 Commando<br>(14.5-mm US)<br><br>OT-64C (14.5-mm CZ)<br><br>PSZH-1V (14.5-mm HU) | BTR-50 (12.7-mm RS)(-)<br><br>Fuchs (20-mm GM)(+)<br><br>WZ 551 (25-mm CH)(+)<br><br>MT-LB (7.62-mm RS/BU)(*)<br><br>M113 (7.62-mm US)(*)<br><br>BTR-152K (12.7-mm RS)(*)<br><br>FMC AIFV (12.7/25-mm TU/BE)(+) |
| KEY: (+) More capable. (-) Less capable. (*) Different capabilities for special uses.                  |   |   |

Mortar Substitution Matrix

| Baseline Systems  | Potential Substitutes |   |
|---|-----------------------|---|
|   | Comparable            | Alternative   |
| Light Mortar<br>Type M-83A (60-mm CH)   | Al Jaleel (60-mm IZ)  | M2 (60-mm US)(-)<br>M-90 (60-mm SR)(+)<br>MO-120-60 (60-mm FR)(+)<br>AML-60-20 (60-mm FR)(*)  |
| M1937 (82-mm RS)  | M29A1 (81-mm US)      | M125A1/A2 (81-mm/M113 US)(*)<br>MO-81-61L (81-mm FR)(+)   |
| 2B9 (82-mm Automatic RS)  | None                  | 2B9M (82-mm/MT-LB HU)(*)  |
| M1943 (120-mm RS)<br>2S12 (120-mm/GAZ-66 RS)  | Al Jaleel (120-mm IZ) | M-74 (120-mm SR)(+)<br>MO-120-RT-61 (120-mm FR)(+)<br>B1.10.74 (120-mm/MT-LB BU)(*)<br>2B16 (120-mm Combo Gun RS)(*)<br>2S23 (120-mm SP Combo Gun/<br>BTR-80 RS)(*) |
| KEY: (+) More capable. (-) Less capable. (*) Different capabilities for special uses. |                       |   |

**Towed Artillery Substitution Matrix**

| Baseline Systems  | Potential Substitutes   |  |
|---|---|--|
|   | Comparable  | Alternative  |
| D-30 (122-mm RS)  | BS-3 (100-mm RS)<br>LG-1 (105-mm FR)<br>D-74 (122-mm RS)        | M48 Tito Gun (76-mm SR)(-)<br>D-48 (85-mm RS)(-)<br>M101 (105-mm US)(-)<br>M1938/M-30 (122-mm RS)(-) |
| D-20 (152-mm RS)  | M198 (155-mm US)  | ML-20 (152-mm RS)(-)<br>D-1 (152-mm RS)(-)<br>2A65 (152-mm)(+)<br>M114 (155-mm US)(-)                |
| 2A36 (152-mm RS)  | Type 83 (152-mm CH)<br>M46/84 (155-mm SR)<br>GHN-45 (155-mm AU) | M-46 (130-mm RS)(-)<br>A-19 (122-mm RS)(-)<br>2A65 (152-mm)(+)                                       |
| S-23 (180-mm RS)  | None  | M1931/B-4M (203-mm RS)(*)  |
| KEY: (+) More capable. (-) Less capable. (*) Different capabilities for special uses. |   |  |

Self-Propelled Artillery Substitution Matrix \_\_\_\_\_

| Baseline Systems  | Potential Substitutes  |  |
|---|--|--|
|   | Comparable   | Alternative  |
| 2S1 (122-mm RS)   | Abbot (105-mm UK)<br>Type 85 (122-mm CH)                         | M1977 (122-mm KN)(-)<br>Type 54-1 (122-mm CH)(-)<br>2S23 (120-mm SP Combo Gun/<br>BTR-80 RS)(*)<br>2S9 (120-mm SP Combo Gun/<br>BTR-D RS)(*) |
| 2S3 (152-mm RS)   | Dana (152-mm CZ)<br>Palmaria (155-mm IT)<br>M109A1/3 (155-mm US) | M1974 (152-mm KN)(-)<br>AS-90 (155-mm UK)(+)<br>AU-F1 (155-mm FR)(+)<br>G6 (155-mm SF)(+)<br>2S19 (152-mm RS)(+)                             |
| 2S5 (152-mm RS)   | None   | Catapult (130-mm IN)(-)  |
| KEY: (+) More capable. (-) Less capable. (*) Different capabilities for special uses. |  |  |

**Rocket Launcher Substitution Matrix**

| Baseline Systems  | Potential Substitutes  |   |
|---|--|---|
|   | Comparable   | Alternative   |
| Single-Tube Rocket Launcher<br>BM-21P (122-mm RS)                                     | SAKR PRL-111 (122-mm EG)   | SAKR PRL-81 (107-mm EG)(-)<br>SAKR-4 (4-Tube 122-mm MRL<br>EG)(+)         |
| Multiple Rocket Launcher<br>BM-21 (122-mm RS)   | SAKR RL-21 (122-mm EG)<br>M-77/Oganj (128-mm SR)<br>Firos (122-mm IT)<br>Astros II (127-mm BR) | Type 85 (130-mm CH)(-)<br>RM-70 (122-mm CZ)(+)<br>M51 (130-mm CZ)(-)      |
| Multiple Rocket Launcher<br>RPU-14 (140-mm RS)  | Type 63 (107-mm CH)  | LAU-97 (70-mm BE)(*)<br>Type 81 (107-mm CH)(*)<br>M-63 (128-mm SR)(*)     |
| Multiple Rocket Launcher<br>9P140/BM-22 (220-mm RS)                                   | Astros II (180-mm BR)<br>M1985 (240-mm KN)   | M-87/Orkan (262-mm SR)(+)<br>M1991 (240-mm KN)(+)<br>BM-24 (240-mm RS)(-) |
| KEY: (+) More capable. (-) Less capable. (*) Different capabilities for special uses. |  |   |

**Artillery Rocket and Surface-to Surface Missile Substitution Matrix** \_\_\_\_\_

| Baseline Systems  | Potential Substitutes      |  |
|---|----------------------------|--|
|   | Comparable                 | Alternative                            |
| FROG-7 (RS)   | Layth (IZ)                 | SS-21/SCARAB (RS)(+)<br>Nazeat (IR)(+) |
| SS-21/SCARAB (RS)   | Prithvi (IN)<br>B-610 (CH) | Nazeat (IR)(-)                         |
| SS-1c/SCUD B  | M-11 (CH)                  | M-9 (CH)(+)<br>SCUD C (KN)(+)          |
| KEY: (+) More capable. (-) Less capable. (*) Different capabilities for special uses. |                            |  |

## Antitank Weapon Substitution Matrix

| Baseline Systems  | Potential Substitutes   |  |
|---|---|--|
|   | Comparable  | Alternative  |
| Disposable ATRL<br>RPG-18 (64-mm RS)<br><br>RPG-22 (72-mm RS)                         | M72 LAW (66-mm US)<br><br>AT-4 (84-mm SW)<br><br>C90-C (90-mm SP)                           | RPG-27 (105-mm RS)(+)<br><br>Hornet RBR (120-mm SR)(+)<br><br>RPO-A Flamethrower (110-mm RS)(*)  |
| ATGL<br>RPG-7V (40-mm RS)<br><br>RPG-16D (58-mm RS)                                   | Type 69 (40-mm CH)<br><br>Panzerfaust-3 (60-mm GM)<br><br>Carl Gustaf M-2/M-3<br>(84-mm SW) | RPG-2 (40-mm RS)(-)<br><br>RPG-29 (105-mm RS) (+)<br><br>Folgore (80-mm IT)(*)<br><br>Hornet-S (120-mm SR)(*)<br><br>RPO Flamethrower (110-mm RS)(*)   |
| Recoilless Gun:<br>SPG-9 (73-mm RS)   | M-60A (82-mm SR)<br><br>M79 (82-mm SR)<br><br>CAN-90L (90-mm BE)                            | B-10 (82-mm RS)(-)<br><br>B-11 (107-mm RS)(-)<br><br>M40A1 (106-mm US)(+)  |
| Antitank Gun<br>T-12/MT-12 (100-mm RS)  | M87/Topaz (100-mm SR)   | ZIS-3 (76-mm RS)(-)<br><br>SD-44 (85-mm RS)(-)<br><br>BS-3 (100-mm RS)(-)<br><br>2A45M (125-mm RS)(+)<br><br>ASU-57 (57-mm Assault Gun RS)(*)<br><br>ASU-85 (85-mm Assault Gun RS)(*)<br><br>SU-100 (100-mm Assault Gun RS)(*) |
| KEY: (+) More capable. (-) Less capable. (*) Different capabilities for special uses. |   |  |

(continued)

Antitank Weapon Substitution Matrix (continued)

| Baseline Systems  | Potential Substitutes   |  |
|---|---|--|
|   | Comparable  | Alternative  |
| ATGM Manpack<br>AT-7/SAXHORN (RS)   | Dragon (US)   | AT-4/SPIGOT (RS)(+)<br>AT-13/Metis-2 (RS)(+)<br>AT-3/Malyutka-2 (RS)(*)<br>Milan (FR)(+)<br>Eryx (FR)(*) |
| ATGM Manpack<br>AT-4/SPIGOT (RS)  | Red Arrow 8 (CH)<br>HOT (FR)<br>TOW (US)                        | AT-14/Kornet(RS)(+)<br>RBS-56/Bill (SW)(*)<br>AT-5/SPANDREL (Ground/Vehicle-Launched RS)(*)              |
| ATGM Vehicle<br>9P133 (BRDM-2 with<br>AT-3/SAGGER)(RS)                                | VAB/Milan (FR)  | M60PB AT (SR)(-)   |
| ATGM Vehicle<br>9P148 (BRDM-2 with<br>AT-5/SPANDREL) (RS)                             | VCR/TH with HOT (FR)<br>M901/TOW (US)<br>Striker/Swingfire (UK) | 9P137 (BRDM-2 with<br>AT-2c/SWATTER C (RS)(-)<br>Rooikat 35/ZT-3 (SF)(+)                                 |
| KEY: (+) More capable. (-) Less capable. (*) Different capabilities for special uses. |   |  |



Antiaircraft Gun Substitution Matrix

| Baseline Systems  | Potential Substitutes  |  |
|---|--|--|
|   | Comparable   | Alternative  |
| ZPU-2/-4 (14.5-mm RS)   | Type 56 (14.5-mm CH)<br>Type 58 (14.5-mm CH)<br>Type 75 (14.5-mm CH)<br>Type 80 (14.5-mm CH) | M-53 (12.7-mm CZ)(-)   |
| ZU-23 (23-mm RS)  | Type 80 (23-mm CH)   | Type 85 (25-mm CH)(+)<br>M1990 (30-mm KN)(+)   |
| ZSU-23-4 (23-mm SP AA Gun RS)   | M1992 (30-mm KN)   | Marksman (35-mm UK)(+)   |
| M1939 (37-mm RS)  | Type 55 (37-mm CH)   | Bofors L/70 (40-mm SW)(+)  |
| S-60 (57-mm RS)   | Type 59 (57-mm CH)   | KS-12 (85-mm RS)(+)<br>KS-19 (100-mm RS)(+)<br>ZSU-57-2 (57-mm SP AA Gun RS)(*<br>Type 80 (57-mm SP AA Gun CH)(*<br> |
| KEY: (+) More capable. (-) Less capable. (*) Different capabilities for special uses. |  |  |

Surface-to-Air Missile Substitution Matrix

| Baseline Systems  | Potential Substitutes  |  |
|---|--|--|
|   | Comparable   | Alternative  |
| First-Generation Shoulder-Fired SAM<br><br>SA-7/GRAIL (RS)  | HN-5 (CH)<br>Redeye (US)<br>SAKR-Eye (EG)<br>Blowpipe (UK)       | (See Second- and Third-Generation Shoulder-Fired SAM, below) (+) |
| Second- and Third-Generation Shoulder-Fired SAM<br><br>SA-14/GREMLIN (RS)<br>SA-16/GIMLET (RS)<br>SA-18/GROUSE (RS) | Stinger RMP (US)<br>Mistral (FR)<br>RBS-70 (SW)<br>Vanguard (CH) | (See First-Generation Shoulder-Fired SAM, above)(-)              |
| SA-6/GAINFUL (RS)   | RF-161A (CH)   | SA-8/GECKO (RS)(+)   |
| SA-8/GECKO (RS)   | Roland II (FR)   | SA-6/GAINFUL (RS)(-)   |
| SA-9/GASKIN (RS)  | None   | SA-13/GOPHER (RS)(+)<br>Chaparral (US)(+)                        |
| SA-2/GUIDELINE (RS)<br>SA-3/GOA (RS)  | HQ-1 (CH)<br>HQ-2 (CH)   | SA-5/GAMMON (RS)(+)<br>SA-10c/GRUMBLE (RS)(+)                    |
| SA-4/GANEF (RS)   | None   | SA-11/GADFLY (RS)(+)   |
| SA-11/GADFLY (RS)   | None   | Crotale NG (FR)(-)   |
| KEY: (+) More capable. (-) Less capable. (*) Different capabilities for special uses.                               |  |  |

Attack Helicopter Substitution Matrix \_\_\_\_\_

| Baseline Systems  | Potential Substitutes |   |
|---|-----------------------|---|
|   | Comparable            | Alternative   |
| Mi-24 (Mi-25)/HIND D/E/F (RS)   | None                  | Hughes 500 Defender (US)(-)<br>SA 342 Gazelle (FR)(-) |
| KEY: (+) More capable. (-) Less capable. (*) Different capabilities for special uses. |                       |   |

## Appendix B Engineer Equipment Substitution Matrices

The matrices contained in this appendix illustrate some of the different equipment options available to scenario and order of battle developers. Although this organization guide provides a baseline of widely-used systems produced in the former Soviet Union (FSU), the intent of the capabilities-based OPFOR is to allow users to tailor their orders of battle by substituting other worldwide systems. Deviations from the baseline systems should relate to specific training objectives. For example, users may desire to mirror the actual mix of equipment found in a particular region or to introduce a particular capability or vulnerability.

The matrices list most of the major **baseline** engineer systems contained in the organization guide and provide a number of potential substitutes for each. While the lists of **potential substitutes** are not all-inclusive, they contain most common systems that have roughly **comparable** capabilities. They also contain some **alternative** systems that may perform the same missions (with greater or lesser capability) or have different capabilities for special uses. Entries include the system name and the digraph for country of origin. Entries within the alternative category also include one of the following symbols identifying each system's capabilities in relation to the baseline:

- (+) More capable.
- (-) Less capable.
- (\*) Different capabilities for special uses.

Users substituting systems from the matrices or considering other foreign weapons systems for use in an OPFOR order of battle should evaluate candidate substitutes against the same basic criteria as in Appendix A.

**Amphibious Transporter and Ferry Substitution Matrix** \_\_\_\_\_

| Baseline Systems   | Potential Substitutes    |  |
|--|--------------------------|--|
|  | Comparable               | Alternative  |
| GSP Ferry (RS)   | None                     | PMM-2 (RS)(+)<br>M-2/-3 (GM)(+)<br>PFM (FR)(+)<br>BAC Automone 40/60 (FR)(+)<br>2TFR (IS)(+)<br>Type-70 (JA)(+)<br>Mobile Assault Bridge (US)(-) |
| PTS Amphibious Transporter (RS)  | PTS-M (RS)<br>PTS-2 (RS) | BAV 485 (RS)(-)<br>K-61 (RS)(-)<br>LARC (US)(-)  |
| <b>KEY: (+) More capable. (-) Less capable. (*) Different capabilities for special uses.</b> |                          |  |

*NOTE:* The greatest discriminator in capability here is whether the system could be autonomous or requires assembly with other sections.

## Bridging Substitution Matrix

| Baseline Systems  | Potential Substitutes   |  |
|---|---|--|
|   | Comparable  | Alternative  |
| TMM Truck-Launched Bridge (RS)  | Truck-Mounted Scissors Treadway Bridge (SR)<br>AM-50 (CZ)<br>GQL-110/Type-84 (CH)   | Bundeswehr (FSB)(+)<br>KMM (RS)(-)<br>Type-81 (JA)(+)<br>SMT-1 (PL)(-)<br>Type 69 (CH)(-)        |
| MTU-20 Tank-Launched Bridge (RS)  | M48/AVLB (US)<br>MT-55 (CZ)<br>BLG-60 (GM)<br>Biber Bridgelayers (GM)<br>Yugoslav Tank-Launched Bridge (SR)<br>Type 84 (CH)<br>Type-67 (JA) | MTU-72 (RS)(+)<br>BLP-72 (GM)(+)<br>AMX-30/13 (FR)(+)<br>Pz-68 (SZ)(+)<br>Chieftain AVLB (UK)(+) |
| KEY: (+) More capable. (-) Less capable. (*) Different capabilities for special uses. |   |  |

*NOTE:* The main discriminator in capability here is the chassis. More modern, faster-moving, more heavily armored chassis improve mobility and survivability factors. However, the bridge specifications are all similar.

(continued)

**Bridging Substitution Matrix (continued)** \_\_\_\_\_

| Baseline Systems  | Potential Substitutes   |   |
|---|---|---|
|   | Comparable  | Alternative                                     |
| PMP Heavy Folding Pontoon Bridge (RS)   | Type 79 (CH)<br>Type 74 (CH)<br>M-71 (SR)<br>Ribbon Bridge (US)<br>PFM (FR)<br>Folding Float Bridge (GM)<br>DAF YGZ 2300 (NL)<br>PR-60 (RO)<br>PP-64 (PL) | None<br>(All have fairly similar capabilities.) |
| KEY: (+) More capable. (-) Less capable. (*) Different capabilities for special uses. |   |   |

*NOTE:* The main discriminator in capability here is the chassis. More modern, faster-moving, more heavily armored chassis improve mobility and survivability factors. However, the bridge specifications are all similar.

**Ditching and Trenching Machine Substitution Matrix**

| Baseline Systems  | Potential Substitutes |   |
|---|-----------------------|---|
|   | Comparable            | Alternative   |
| MDK/MDK-2M/MDK-3M<br>Ditcher (RS)   | M1987 (CH)            | None  |
| BMT/BMT-3/BMT-4<br>Trencher (RS)  | M1984 (CH)            | TMK (RS)(-)<br>PZM (RS)(-)<br>Model 260 (CH)(-)<br>Type 74 (CH)(-)<br>SEE (US)(-)<br>Case & John Deer<br>Backhoe/Loader (US)(-)<br>Matenin Trencher (FR)(-) |
| KEY: (+) More capable. (-) Less capable. (*) Different capabilities for special uses. |                       |   |

**NOTE:**

1. For trenchers, the greatest discriminator in capability is chassis mobility. Only the BTM series and the M 1984 are tracked. The rest are all wheeled, which degrades mobility.
2. Unlike the other systems, the Case and John Deer systems do not have a rotary trencher but can still use a bucket or backhoe to make a trench, achieving the same results.



Minelaying Equipment Substitution Matrix

| Baseline Systems  | Potential Substitutes  |  |
|---|--|--|
|   | Comparable   | Alternative  |
| PMR-3 Towed Minelaying Trailer (RS)   | PZM-4 (RS)<br>MLG-69 (GM)<br>Type 73/GBL-120 (CH)<br>FFV-5821 (SW)<br>Yugoslav Towed Minelayer (SR)<br>Barmine Minelayer (UK)<br>Type-83 (JA)<br>ST-AT/V (IT)<br>M-57 ATMDS (US) | PMR-2 (RS)(-)<br>M1985 (CH)(+)<br>PM-16 (FR)(+)  |
| GMZ Armored Tracked Minelaying Vehicle (RS)   | MV-90 (CZ)<br>M1989 (CH)<br>M1991 (SR)   | PM-11 (FR)(-)<br>VZ-92 (CZ)(*)   |
| UMZ Mine-Scattering Vehicle (RS)  | Volcano (US)<br>Istrice (!T)<br>SAKR Mine-Dispensing System (EG)   | Skorpion (GM)(+)<br>Minotaur (FR)(+)<br>GEMSS (US)(-)<br>VZ-92 (CZ)(*)<br>Spartan (UK)(+)<br>M1993 (CH)(+) |
| KEY: (+) More capable. (-) Less capable. (*) Different capabilities for special uses. |  |  |

NOTE: For towed minelayers, the main discriminator in capability is the ability to feed mines automatically, rather than manually. For self-propelled systems, the main discriminators are mobility and survivability.

**Mineclearing Equipment Substitution Matrix**

| Baseline Systems  | Potential Substitutes                             |   |
|---|---|---|
|   | Comparable  | Alternative   |
| DIM Vehicle-Mounted Mine Detection System (RS)  | ML-1621 (GM)<br>ML-1750 (GM)                      | MDV (SF)(*)<br>VMMD (SF)(*)<br>Road Runner Detection System (SF)(*)   |
| MTK/MTK-2 Explosive Mineclearing Vehicle (RS)   | MICLIC (US)<br>AVLM (US)<br>Type 762/GSL-111 (CH) | SAKR Mineclearing System (EG)(-)<br>LWD Line Charge Attachment for Vehicles (PL)(*)<br>Giant Viper (UK)(-)<br>Plofadder Line Charge Attachment for Vehicles (SF)(*)<br>Type 84 (CH)(*)<br>SVO (CZ)(*)<br>M1987 MRL (CH)(*)<br>Type 81 MRL (CH)(*) |
| KEY: (+) More capable. (-) Less capable. (*) Different capabilities for special uses. |   |   |

**NOTES:**

1. The LWD, Plofadder, and Type 84 are not actually mineclearing vehicles, but rather attachments to mount on any designated vehicles, such as tanks.
2. Unlike the MTK and MTK-2, the SVO, M1987, and Type 81 do not use line charges, but rather dispense multiple explosive rockets into the minefield.

(continued)

Mineclearing Equipment Substitution Matrix (continued)

| Baseline Systems  | Potential Substitutes   |  |
|---|---|--|
|   | Comparable  | Alternative                              |
| KMT-4/KMT-6<br>Tank-Mounted<br>Mine Plow (RS)   | TWMP Track-Width<br>Mine Plow (IS)<br><br>EMP (UK)<br><br>M1982 (CH)<br><br>SADF Mine Plow (SF)   | None<br>(All have similar capabilities.) |
| KMT-5/KMT-7<br>Track-Width<br>Mine Roller (RS)  | PT-54/PT-55 (RS)<br><br>TWMP & Roller (US)<br><br>SADF Mine Roller (SF)<br><br>RKM Mine Rollers (IS)<br><br>D-5M (RO)<br><br>Minvalt-1 (SW) | None<br>(All have similar capabilities.) |
| KEY: (+) More capable. (-) Less capable. (*) Different capabilities for special uses. |   |  |

**Armored Engineer and Route-Clearing  
Vehicle Substitution Matrix**

| Baseline Systems  | Potential Substitutes                              |   |
|---|--|---|
|   | Comparable   | Alternative   |
| IMR Armored Engineer Vehicle (RS)   | IMR-2 (RS)<br>Steyr Pionierpanzer (AU)<br>IWT (PL) | Grizzly (Developmental US)(+)<br>AMX-30 Combat Engineer Tractor (FR)(*)<br>Pionierpanzer-2 Dachs (GM)(*)<br>Leopard-1 Armored Engineer Vehicle (GM)(*)<br>CEV (US)(-)<br>Type-67 (JA)(-)<br>CET (UK)(-) |
| BAT/BAT-M Route-Clearing Vehicle (RS)   | None   | BAT-2 (RS)(+)<br>M-9 ACE (US)(-)<br>Type-75 (JA)(-)<br>PKT (RS)(-)<br>BKT (RS)(-)<br>D-7/D-9 Dozer (US)(-)  |
| KEY: (+) More capable. (-) Less capable. (*) Different capabilities for special uses. |  |   |

**NOTES:**

1. The BAT-2 can also carry a combat engineer squad.
2. The armored engineer vehicles for special uses (\*) include specialty equipment such as augers and mine dispensers.
3. Among the route-clearing vehicles, the M-9 ACE, Type-75, D-7, and D-9 have no crane and are slow-moving. The PKT and BKT are wheeled vehicles with little armor.

**Engineer Reconnaissance Vehicle Substitution Matrix** \_\_\_\_\_

| Baseline Systems  | Potential Substitutes |  |
|---|-----------------------|--|
|   | Comparable            | Alternative                            |
| IRM (RS)  | IPR (RS)              | TRI/MT-LB (PL)(-)<br>SEV/M-113 (CA)(-) |
| KEY: (+) More capable. (-) Less capable. (*) Different capabilities for special uses. |                       |  |

**Tank-Mounted Dozer Blade Substitution Matrix** \_\_\_\_\_

| Baseline Systems  | Potential Substitutes   |  |
|---|---|--|
|   | Comparable  | Alternative                              |
| BTU Dozer Blade (RS)  | Type 653 (CH)<br>RKM Dozer Blade (IS)<br>ABK-3 (IS)<br>UDK-1/UDK-2 (UK)<br>M-8/M-9 (US) | None<br>(All have similar capabilities.) |
| KEY: (+) More capable. (-) Less capable. (*) Different capabilities for special uses. |   |  |

## Appendix C

### Cargo Truck, Trailer, and Radio Substitution

This manual uses generic descriptors to indicate truck and trailer capacity and radiocapabilities. The following list, based on equipment produced in the former Soviet Union, provides a definition of terms and examples of equipment types in each generic category. However, users may substitute any comparable piece of equipment that falls within the range of capabilities for each system.

#### Trucks

---

| Type           | Drive | Load Capacity     | Examples   |
|----------------|-------|-------------------|--|
| Truck, Utility | 4 x 4 | 500 to 600 kg     | GAZ-69 (RS)<br>UAZ-469 (RS)<br>Land Rover Defender 130 (UK)<br>IMR A-0.75 (SR)           |
| Truck, Light   | 4 x 4 | 1 to 2.5 mt       | GAZ-66 (RS)<br>GAZ-3301 (RS)<br>TAM 110 T7 BV (SR)<br>Renault TRM 2000 (FR)              |
| Truck, Medium  | 6 x 6 | 2.5 to 7 mt       | URAL-375D (RS)<br>ZIL-131 (RS)<br>ZIL-157K (RS)  |
| Truck, Heavy   | 6 x 6 | 7.5 mt or greater | KrAZ-255B (RS)<br>KrAZ-260 (RS)<br>IVECO Magirus 160-23 ANWM (GM)<br>AWD Bedford TM (UK) |

Trailers

---

| Type                   | Load Capacity | Examples                | Towed By                       |
|------------------------|---------------|-------------------------|--------------------------------|
| Trailer, Cargo, 1-Axle | 0.5 mt        | GAZ-704 (RS)            | UAZ-3151 (RS)                  |
|                        |               | UAZ-8109 (RS)           | UAZ-469 (RS)                   |
|                        |               | GKN Defence 750-kg (UK) |                                |
|                        | 1.5 mt        | TAPZ-755 (RS)           | GAZ-66 (RS)                    |
|                        |               | M104 Series (US)        |                                |
| Trailer, Cargo, 2-Axle | 2.5 to 4.0 mt | GAZ-710 (RS)            | ZIL-131 (RS)                   |
|                        |               | IAPZ-754V (RS)          | URAL-375D (RS)                 |
|                        |               | 782V (RS)               | URAL-4320 (RS)                 |
|                        | up to 6.8 mt  | MAZ-5243 (RS)           | MAZ-500 (RS)<br>KrAZ-255B (RS) |

**Radios**

| Type                             | Example                  | Power Output   | Frequency        | Range          |
|----------------------------------|--------------------------|----------------|------------------|----------------|
| VHF, Manpack, Low-Power          | R-107 (RS)               | 1 W            | 20 to 52 MHz     | 6 to 25 km     |
| VHF, Portable, Low-Power         | R-148 (RS)               | 1.1 to 2.1 W   | 37 to 51.95 MHz  | 5 km           |
| VHF, Portable, Very-Low-Power    | R-126 (RS)               | 0.5 W          | 48.5 to 51 MHz   | 1 to 4 km      |
| VHF, Vehicle Mount, Medium-Power | R-123 (RS)               | 20 W           | 20 to 51.5 MHz   | 20 to 50-km*   |
| HF, Manpack, Low-Power           | R-104M (RS)              | 1 to 3.5 W     | 1.5 to 4.25 MHz  | 20 to 50 km**  |
| HF, Vehicle Mount, Medium-Power  | R-130 (RS)               | 10 to 40 W     | 1.5 to 10.99 MHz | 50 to 75 km*** |
| HF, Vehicle Mount, High-Power    | R-118 (RS)               | 150 to 250 W   | 1.0 to 7.5 MHz   | up to 600 km   |
| Radio Relay, VHF                 | R-401 (RS)<br>R-403 (RS) | 2.5 W          | 60 to 70 MHz     | 40 to 50 km    |
| Radio Relay, UHF                 | R-405 (RS)               | 2.5 W          | 320 to 420 MHz   | 40 to 50 km    |
| Warning Receiver                 | R-311 (RS)               | Not Applicable | 1 to 15 MHz      | Not Applicable |

**FOOTNOTES:**

- \* Range is 20 km while on the move; 50 km while stationary with telescoping antenna.
- \*\* Range is 20 to 30 km with whip antenna; 30 to 50 km with long wire antenna.
- \*\*\* Range is 50 km with whip 4-meter antenna; 75 km with 10-meter whip antenna or sloping wire antenna; up to 350 km with symmetrical dipole antenna.



## Glossary

|   |  |
|---|--|
| <b>AA</b> - antiaircraft                                      | <b>DAG</b> - division artillery group                |
| <b>abn</b> - airborne   | <b>decon</b> - decontamination                       |
| <b>acq</b> - acquisition                                      | <b>DF</b> - direction-finding                        |
| <b>ACRV</b> - artillery command and<br>reconnaissance vehicle | <b>div</b> - division or divisional                  |
| <b>ACV</b> - armored command vehicle                          | <b>DMI</b> - Directorate of Military<br>Intelligence |
| <b>AD</b> - air defense                                       | <b>EC</b> - electronic combat                        |
| <b>ADC</b> - Air Defense Command                              | <b>EG</b> - Egypt                                    |
| <b>admin</b> - administration                                 | <b>enr</b> - engineer                                |
| <b>aer surv</b> - aerial surveillance                         | <b>FDC</b> - fire direction center                   |
| <b>AGL</b> - automatic grenade launcher                       | <b>FR</b> - France                                   |
| <b>ammo</b> - ammunition                                      | <b>FROG</b> - free rocket over ground                |
| <b>APC</b> - armored personnel carrier                        | <b>FSU</b> - former Soviet Union                     |
| <b>arty</b> - artillery                                       | <b>GM</b> - Germany                                  |
| <b>ASC</b> - armored scout car                                | <b>GP</b> - general-purpose                          |
| <b>asst</b> - assistant                                       | <b>gun-how</b> - gun-howitzer                        |
| <b>AT</b> - antitank  | <b>HF</b> - high-frequency                           |
| <b>ATGL</b> - antitank grenade launcher                       | <b>HMG</b> - heavy machinegun                        |
| <b>ATGM</b> - antitank guided missile                         | <b>HQ</b> - headquarters                             |
| <b>ATRL</b> - antitank rocket launcher                        | <b>HU</b> - Hungary                                  |
| <b>AU</b> - Austria   | <b>hvy</b> - heavy                                   |
| <b>auto</b> - automatic                                       | <b>IFV</b> - infantry fighting vehicle               |
| <b>avn</b> - aviation   | <b>IN</b> - India                                    |
| <b>bde</b> - brigade  | <b>inf</b> - infantry                                |
| <b>BE</b> - Belgium   | <b>intcp</b> - intercept                             |
| <b>bn</b> - battalion   | <b>IOC</b> - initial operational capability          |
| <b>BR</b> - Brazil  | <b>IS</b> - Israel                                   |
| <b>BrAG</b> - brigade artillery group                         | <b>IT</b> - Italy                                    |
| <b>btry</b> - battery   | <b>IZ</b> - Iraq                                     |
| <b>BU</b> - Bulgaria  | <b>JA</b> - Japan                                    |
| <b>CA</b> - Canada  | <b>kg</b> - kilogram                                 |
| <b>CDF</b> - Capital Defense Forces                           | <b>KN</b> - North Korea                              |
| <b>cdr</b> - commander  | <b>km</b> - kilometer                                |
| <b>chem</b> - chemical  |  |
| <b>CH</b> - China   |  |
| <b>CM/CB</b> - countermortar/counterbattery                   |  |
| <b>co</b> - company   |  |
| <b>const</b> - construction                                   |  |
| <b>COP</b> - command observation post                         |  |
| <b>CZ</b> - Czechoslovakia                                    |  |

## FM 100-63

**l** - liter

**lchr** - launcher

**LMG** - light machinegun

**maint** - maintenance

**mat spt** - maintenance support

**MD** - military district

**MDAG** - military district artillery group

**mech inf** - mechanized infantry

**med** - medical or medium

**met** - meteorological

**MG** - machinegun

**MHZ** - megahertz

**MININT** - Ministry of the Interior

**mm** - millimeter

**MRAG** - military region artillery group

**MRL** - multiple rocket launcher

**msl** - missile

**mt** - metric ton

**mtzd inf** - motorized infantry

**NBC** - nuclear, biological, and chemical

**NCO** - noncommissioned officer

**NL** - Netherlands

**OPFOR** - Opposing Force

**ord** - ordnance

**photo-recon** - photographic  
reconnaissance

**PL** - Poland

**plt** - platoon

**POL** - petroleum, oil, and lubricants

**prep** - preparation

**recon** - reconnaissance

**recon & EC** - reconnaissance and  
electronic combat

**regt** - regiment

**RO** - Romania

**RPV** - remotely-piloted vehicle

**RS** - Russia

**R/T** - radio telephone

**SAM** - surface-to-air missile

**sect** - section

**sep** - separate

**SF** - South Africa

**SOC** - Special Operations Command

**SP** - self-propelled or Spain

**SPF** - special-purpose forces

**spt** - support

**sqd** - squad

**sqdn** - squadron

**SR** - Serbia

**SSM** - surface-to-surface missile

**svc** - service

**SW** - Sweden

**SZ** - Switzerland

**tech** - technical

**TEL** - transporter-erector-launcher

**TELAR** - transporter-erector-launcher  
and radar

**tgt acq** - target acquisition

**topo** - topographical

**torp** - torpedo

**TU** - Turkey

**UHF** - ultrahigh-frequency

**UK** - United Kingdom

**US** - United States

**veh** - vehicle

**VHF** - very-high-frequency

**W** - watt

**warn** - warning

**WO** - warrant officer

**wpn** - weapon

**ZI** - Zimbabwe

# References

## REQUIRED PUBLICATIONS

*These required publications are sources that users must read in order to understand this publication fully.*

### Field Manuals (FMs)

FM 100-60. *Armor- and Mechanized-Based Opposing Force: Organization Guide.*  
(To be published.)

FM 100-61. *Armor- and Mechanized-Based Opposing Force: Operational Art.*  
(To be published.)

FM 100-62. *Armor- and Mechanized-Based Opposing Force: Tactics.*  
(To be published.)

FM 100-64. *Infantry-Based Opposing Force: Operations and Tactics.*  
(To be published.)

FM 100-65. *Opposing Force Equipment Guide.*  
(To be published.)

FM 100-66. *Opposing Force in Operations Other Than War.*  
(To be published.)

# Index

Page numbers in **bold type** indicate the main entry for a particular unit; this page usually includes an organization chart and list of principal items of equipment for the indexed unit. Other page numbers indicate organizations in which the indexed unit is subordinate or appears in a note.

## —1—

122-mm Howitzer Battalion  
Arty Regt, 1-11, **1-15**  
Inf Bde (Sep), **1-15**, 3-43  
Mtzd Inf Bde (Sep), **1-15**  
122-mm Howitzer Battery  
122-mm Howitzer Bn, 1-15, **1-16**  
Composite Arty Bn, Abn Inf Bde, 5-21, **5-22**  
122-mm Multiple Rocket Launcher Battalion  
Arty Regt, 1-11, **1-19**  
MRL Bde, **1-19**, 6-11  
SP Arty Regt, **1-19**, 2-10  
122-mm Self-Propelled Howitzer Battalion  
Mech Inf Bde (Sep and Div), **2-14**, 4-3, 4-8  
SP Arty Regt, 2-10, **2-14**  
Tank Bde, **2-14**, 4-36, 4-44  
122-mm Self-Propelled Howitzer Battery,  
122-mm SP Howitzer Bn, 2-14, **2-15**  
152-mm Gun-Howitzer Battalion  
Arty Bde, 1-17, 6-5  
Arty Regt, 1-11, **1-17**  
152-mm Gun-Howitzer Battery,  
152-mm Gun-Howitzer Bn, 1-17, **1-18**  
152-mm Self-Propelled Gun Battalion, Arty Bde, 6-5, **6-10**  
152-mm Self-Propelled Howitzer Battalion, SP Arty Regt,  
2-10, **2-16**  
152-mm Self-Propelled Howitzer Battery,  
152-mm SP Howitzer Bn, 2-16, **2-17**

## —2—

220-mm Multiple Rocket Launcher Battalion,  
MRL Bde, 6-11, **6-14**

## —A—

Airborne Infantry Battalion, Abn Inf Bde, 5-7, **5-10**  
Airborne Infantry Brigade, 5-2, **5-7**  
Airborne Infantry Company, Abn Inf Bn, 5-10, **5-11**  
Airborne Infantry Platoon, Abn Inf Co, 5-11, **5-12**

Airborne Infantry Squad, Abn Inf Plt, 5-12, **5-13**  
Airborne Jamming Aviation Regiment, Air Force,  
8-2, **8-5**  
Air Defense. *See also* Antiaircraft Gun, SAM, and Self-Propelled Antiaircraft Gun.  
Air Defense Command Air Force, 5-3, 7-2, 8-2, **8-9**  
Air Defense Jamming Battalion or Regiment, ADC, **8-9**  
Air Defense Regiment  
ADC, **2-19**, 5-3, 8-9  
Army, **2-19**, 5-5  
CDF, **2-19**, 5-6  
MD, 1-3, **2-19**  
Mech Inf Div, 2-9, **2-19**  
Air Force, vii, 7-2, **8-2**  
Ammunition Transport Company, Mat Spt Bn,  
1-44, **1-45**, 2-41  
Amphibious Support Squadron, Navy, **7-21**  
Antiaircraft Gun Battalion (Mixed), Inf Div, 2-3, **2-4**  
Antiaircraft Gun Battalion (57-mm), Air Defense Regt,  
2-19, **2-24**  
Antiaircraft Gun Battery (37-mm), AA Gun Bn (Mixed), 2-4, **2-6**  
Antiaircraft Gun Battery (57-mm)  
AA Gun Bn (Mixed), **1-28**, 2-4  
AA Gun Bn (57-mm), **1-28**, 2-24  
AA Gun Regt (57-mm), 1-24, **1-28**  
Antiaircraft Gun Battery (23-mm)  
AA Gun Bn (Mixed), 2-4  
Abn Inf Bde, **3-26**, 5-7  
Arty Bde, **3-26**, 6-5  
Arty Regt, 1-11, **3-26**  
Inf Bde (Sep, Div, and Militia), **3-26**, 3-43, 3-46, 3-54  
MRL Bde, **3-26**, 6-11  
Mtzd Inf Bde (Sep and Div), 3-3, 3-6, **3-26**  
SAM Bn (SA-4), **3-26**, 8-18  
Antiaircraft Gun Platoon (37-mm),  
AA Gun Btry (37-mm), **2-6**  
Antiaircraft Gun Platoon (57-mm),  
AA Gun Btry (57-mm), **1-28**  
Antiaircraft Gun Platoon (23-mm),  
AA Gun Btry (23-mm), **3-26**  
Antiaircraft Gun Regiment (100-mm)  
ADC, 1-24, 5-3  
Army, 1-24, 5-5

Antiaircraft Gun Regiment (57-mm)  
   ADC, **1-24**, 5-3, 8-9  
   Army, **1-24**, 5-5  
   Inf Div, **1-24**, 2-3  
   MD, 1-3, **1-24**  
   Mech Inf Div, 2-9, **1-24**  
   Mtzd Inf Div, 1-5, **1-24**  
 Antiaircraft Gun Substitution Matrix, **A-11**  
 Antiaircraft Heavy Machinegun Battery (14.5-mm)  
   AA Gun Bn (Mixed), 2-4, **2-5**, 5-7  
   SAM Bn (SA-2), 2-5, 8-12  
   SAM Bn (SA-3), 2-5, 8-15  
   Abn Inf Bde, **2-5**  
 Antiaircraft Heavy Machinegun Platoon (14.5-mm),  
   AA HMG Btry, **2-5**  
 Antitank. *See also* ATGM.  
 Antitank Battalion. *See also* Antitank Battalion (Standard).  
   Army, **4-26**, 5-5  
   CDF, **4-26**, 5-6  
   MD, 1-3, **2-26**, **4-26**  
   Mech Inf Bde (Sep), **2-26**, 4-3, **4-26**  
   Mech Inf Div, 2-9, **2-26**, **4-26**  
   National, **4-26**, 5-3, 6-4  
 Antitank Battalion (Standard). *See also* Antitank Bn.  
   Army, **1-30**, 5-5  
   MD, 1-3, **1-30**  
   Mtzd Inf Div, 1-5, **1-30**  
   National, **1-30**, 5-3  
 Antitank Guided Missile. *See* ATGM.  
 Antitank Gun Battalion  
   Army, **1-31**, 5-5  
   Inf Div, **1-31**, 2-3  
   MD, 1-3, **1-31**  
   Mtzd Inf Div, 1-5, **1-31**  
   National, **1-31**, 5-3, 6-4  
 Antitank Gun Battery  
   Antitank Bn, Army, 4-26, **4-28**  
   Antitank Bn, CDF, 4-26, **4-28**  
   Antitank Bn, Mech Inf Bde (Sep), 4-26, **4-28**  
   Antitank Bn, Mech Inf Div, 4-26, **4-28**  
   Antitank Bn (Standard), 1-30, **1-32**  
   Antitank Gun Bn, 1-31, **1-32**  
 Antitank Platoon  
   Abn Inf Bde, 5-7, **5-23**  
   Abn Inf Bn, **5-15**  
   Mech Inf Bn (APC), 4-13, **4-22**  
   Wpns Co, Commando Bn, 7-14, **7-16**  
   Wpns Co, Inf Bn, 3-16, **3-19**  
   Wpns Co, Mtzd Inf Bn, 3-16, **3-19**  
 Antitank Weapon Substitution Matrix, **A-9**  
 Armor- and Mechanized-Based OPFOR, v, vi, **viii**, x  
   Large, **ix**  
   Small-to-Medium, **ix**  
 Army. *See* Expeditionary Army.

Artillery. *See also* Gun-Howitzer, Howitzer, Mortar,  
   Multiple Rocket Launcher, Rocket Launcher, Self-  
   Propelled Artillery, Self-Propelled Gun-Howitzer, and  
   Self-Propelled Howitzer.  
 Artillery Battery, Commando Bn, 7-6, **7-12**  
 Artillery Brigade  
   Army, 5-5, **6-5**, 6-6, 6-8  
   CDF, 5-6, **6-5**, 6-6, 6-8  
   National, 5-3, 6-4, **6-5**, 6-6, 6-8  
 Artillery Brigade (5 x 18-Tube Battalion)  
   Army, 5-5, **6-5**, **6-6**  
   National, 6-4, **6-5**, **6-6**  
 Artillery Brigade (4 x 24-Tube Battalion)  
   Army, 5-5, **6-5**, **6-8**  
   National, 6-4, **6-5**, **6-8**  
 Artillery Regiment  
   Army, **1-11**, 5-5  
   Inf Div, 1- **11**, 2-3  
   MD, 1-3, **1-11**  
   Mtzd Inf Div, 1-5, **1-11**  
   National, **1-11**, 5-3, 6-4  
 Artillery Substitution Matrix  
   Self-Propelled, **A-6**  
   Towed, **A-5**  
 Assault Crossing Battalion  
   National, 6-25, **6-45**  
   Water Crossing Regt, 6-41, **6-45**  
 Assault Crossing Company, Engr Bn, 2-30, **2-33**  
 ATGM Battalion  
   Army, **2-26**, 5-5  
   CDF, **2-26**, 5-6  
   National, **2-26**, 5-3, 6-4  
 ATGM Battery  
   Antitank Bn, 1-30, **1-33**, 4-26  
   ATGM Bn, **1-33**, 2-26  
   Inf Bde (Sep), **3-27**, 3-43  
   Inf Div, 2-3, **3-27**  
   Mech Inf Bde (Sep and Div), **3-27**, 4-3, 4-4, 4-5, 4-6, 4-  
     7, 4-8  
   Mech Inf Div, 2-9, **3-27**  
   Mtzd Inf Bde (Sep), 3-3, **3-27**, 4-3  
   Mtzd Inf Div, 1-5, **3-27**  
 ATGM Platoon  
   Abn Inf Bn, 5-10, **5-16**  
   Inf Bde (Div), **3-28**, 3-46  
   Mech Inf Bn (IFV), 4-13, **4-23**  
   Mtzd Inf Bde (Div), 3-6, **3-28**  
 ATGM Section  
   Abn Inf Co, **5-11**  
   Antitank Plt, Abn Inf Bde, **5-23**, **4-22**  
   Antitank Plt, Mech Inf Bn (APC), **4-22**  
   ATGM Plt, Abn Inf Bn, **5-16**  
   ATGM Plt, Mech Inf Bn (IFV), **4-23**  
   ATGM Plt, Mtzd Inf Bde (Div), **3-28**  
   ATGM Plt, Wpns Co, Commando Bn, **7-16**

Attack Helicopter. See Combat Helicopter Regiment.  
Attack Helicopter Substitution Matrix, **A-13**  
Automatic Grenade Launcher Platoon  
  Abn Inf Bn, 5-10, **5-17**  
  Mech Inf Bn, 4-13, **4-20**  
  Wpns Co, Commando Bn, **5-17**, 7-14  
  Wpns Co, Inf Bn, 3-16, **3-20**  
  Wpns Co, Mtzd Inf Bn, 3-16, **3-20**  
Automatic Grenade Launcher Squad  
  AGL Plt, Abn Inf Bn, **5-17**  
  AGL Plt, Mech Inf Bn, **4-21**  
  AGL Plt, Wpns Co, Commando Bn, **5-16**  
  AGL Plt, Wpns Co, Inf Bn, 3-20, **3-21**  
  AGL Plt, Wpns Co, Mtzd Inf Bn, 3-20, **3-21**

—B—

Battalion Headquarters  
  Abn Inf Bn, **5-11**, 5-10  
  Antitank Bn, Army, 1-31, **1-32**, 4-26, **4-27**  
  Antitank Bn, CDF, 4-26, **4-27**  
  Antitank Bn, Mech Inf Bde (Sep), 4-26, **4-27**  
  Antitank Bn, Mech Inf Div, 4-26, **4-27**  
  Antitank Bn (Standard), 1-30, **1-32**  
  Antitank Gun Bn, 1-31, **1-32**  
  ATGM Bn, **1-32**, 2-26  
  Chem Def Bn, 6-48, **6-49**  
  Commando Bn, 7-6, **7-8**  
  Engr Bn, **2-30**  
  Inf Bn, **3-10**, 3-49  
  Maint Bn, 1-48, **1-49**, 2-7, 2-42  
  Mat Spt Bn, 1-44, **1-45**, 2-41  
  Mech Inf Bn, 4-13, **4-15**  
  Med Bn, 2-44, **2-45**  
  Motor Transport Bn, **1-45**, 3-38  
  Mtzd Inf Bn, 3-9, **3-10**  
  Obstacle Clearing Bn, 6-38, **6-39**  
  Pontoon Bridge Bn, 6-43, **6-44**  
  Road & Bridge Bn, 6-30, **6-31**  
  Separate Tank Bn, 1-7, **4-40**  
  Signal Bn, 2-37, **2-38**  
  Tank Bn, Tank Bde, 4-39, **4-40**, 4-47  
Bomber Aviation Regiment, Air Force, **8-3**  
Brigade, xi, **3-1**, **4-1**  
Brigade Headquarters  
  Abn Inf Bde, **5-9**, 5-7  
  Engr Bde, 6-26, **6-29**  
  FROG Bde, 6-17, **6-18**  
  Inf Bde (Militia), 3-54, **3-55**  
  Inf Bde (Sep), 3-43, **3-44**, 3-46  
  Mech Inf Bde (Div), 4-8, **4-9**, **4-11**  
  Mech Inf Bde (Sep), 4-3, **4-4**, **4-6**  
  Mtzd Inf Bde (Sep and Div), 3-3, **3-4**, 3-6, **3-7**  
  SAM Bde (SA-11), **8-20**

SAM Bde(SA-2), 8-10, **8-11**  
SAM Bde (SA-3), 8-13, **8-14**  
SAM Bde (SA-4), **8-16**  
SSM Bde (SCUD), 6-23, **6-24**  
SSM Bde (SS-21), 6-21, **6-22**  
Tank Bde, 4-36, **4-37**, 4-44, **4-45**

—C—

Capabilities-Based OPFOR, v  
Capital Defense Forces, 1-4, 5-2, **5-6**  
Capital District, 1-4, 5-6  
Cargo Transport Company, Mat Spt Bn, 1-44, **1-46**, 2-41  
Central Supply Depot, Mat Spt Bn, 1-44, 2-41  
Chemical Defense Battalion, National, 5-3, 6-47, **6-48**  
Chemical Defense Company  
  Army, **2-40**, 5-5  
  CDF, **2-40**, 5-6  
  Inf Div, **1-43**, 2-3  
  MD, 1-3, **1-43**, **2-40**  
  Mech Inf Div, 2-9, **2-40**  
  Mtzd Inf Div, 1-5, **1-43**  
Chemical Defense Platoon  
  AA Gun Regt **3-35**  
  Abn Inf Bde, 5-7, **5-27**  
  Air Defense Regt, 2-19, **3-35**  
  Arty Bde, **3-35**, 6-5  
  Arty Regt, 1-11, **3-35**  
  Engr Bde, **3-35**, 6-26  
  Inf Bde (Sep and Div), 3-43, 3-46, **3-51**  
  Mech Inf Bde (Sep and Div), **3-35**, 4-3, 4-8  
  MRL Bde, **3-35**, 6-11  
  Mtzd Inf Bde (Sep and Div), 3-3, 3-6, **3-35**  
  SAM Bde (SA-11), **3-35**, 8-20  
  SAM Bde (SA-2), **3-35**, 8-10  
  SAM Bde (SA-3), **3-35**, 8-13  
  SAM Bde (SA-4), **3-35**, 8-16  
  SAM Regt (SA-6 or SA-8), **3-35**, 8-24, 8-32  
  SP Arty Regt, 2-10, **3-35**  
  Tank Bde, **3-35**, 4-36, 4-44  
Chemical Reconnaissance Company, Chem Def Bn,  
  6-48, **6-50**  
Chemical Troops, National, 6-3, **6-47**  
Civil Defense Forces, Internal Security Forces, **7-25**  
Coastal Defense Battery, Navy, **7-21**  
Collection and Evacuation Company, Med Bn, 2-44, **2-46**  
Combat Engineer Company  
  Engr Bn, 2-30, **2-32**  
  MR, **2-32**, 5-3  
Combat Helicopter Regiment, Air Force, 8-2, **8-4**  
Commando Battalion  
  CDF, 5-6, **7-6**  
  MD, 1-3, **7-6**  
  SOC, 7-3, **7-6**

Commando Company, Commando Bn, 7-6, **7-8**  
 Commando Platoon, Commando Co, 7-8, **7-9**  
 Commando Squad, Commando Plt, 7-9, **7-10**  
 Company Headquarters  
   Abn Inf Co, **5-11**  
   Commando Co, **7-8**  
   Inf Co, **3-11**  
   Long-Range Recon Co, Recon & EC Bn, **1-39**  
   Mech Inf Co, **4-16**  
   Mtzd Inf Co, **3-11**  
   Recon Co, Inf Bde (Sep), **3-30**  
   Recon Co, Inf Div, **3-30**  
   Recon Co, MD, **3-30**  
   Recon Co, Mech Inf Bde (APC) (Sep), **4-29**  
   Recon Co, Mech Inf Bde (IFV) (Sep), **4-31**  
   Recon Co, Mtzd Inf Bde (Sep), **3-30, 4-29**  
   Recon Co, Mtzd Inf Div, **3-30**  
   Recon Co, Recon & EC Bn, **1-38, 2-29**  
   Recon Co, Tank Bde, **4-31**  
   Tank Co, **4-41, 4-48**  
 Complex, Adaptive Forces, ix  
 Composite Artillery Battalion, Abn Inf Bde,  
   5-7, **5-21**  
 Construction Company  
   Engr Bn, 2-30, **2-34**  
   Water Crossing Regt, 6-41, **6-42**  
 Corps, **5-5**

—D—

Decontamination Company, Chem Def Bn,  
   6-48, **6-49**  
 Directorate of General Police, Internal Security Forces,  
   7-25  
 Directorate of Military Intelligence, General Staff,  
   1-35, 2-27, 5-3, 7-2, **7-22**  
 Directorate of Operations, General Staff, **7-2**  
 Directorate of Organization and Mobilization, General  
   Staff, **7-2**  
 Directorate of State Security, Internal Security Forces,  
   7-25  
 Disinfection and Decontamination Platoon, Med Bn,  
   2-44, **2-46**  
 Divisional Brigade, xi, **3-1, 4-1**. See Infantry Brigade  
   (Divisional), Mechanized Infantry Brigade (Divisional),  
   or Mechanized Infantry Brigade (Divisional).  
 Divisional Infantry Brigade. See Infantry Brigade  
   (Divisional), Mechanized Infantry Brigade (Divisional),  
   or Mechanized Infantry Brigade (Divisional).  
 Division Headquarters  
   Inf Div, **1-6, 2-3, 2-9**  
   Mech Inf Div, **1-6**  
   Mtzd Inf Div, 1-5, **1-6**

—E—

Electronic Combat. See Reconnaissance and Electronic  
   Combat.  
 Enemy, vii  
 Engineer Battalion  
   Army, **2-30, 5-5**  
   CDF, **2-30, 5-6**  
   Inf Div, 2-3, **2-30**  
   MD, 1-3, **2-30**  
   Mech Inf Div, 2-9, **2-30**  
   MR, **3-33, 5-3**  
   Mtzd Inf Div, 1-5, **2-30**  
   National (Engr Bde), **2-30, 5-3, 6-25, 6-26**  
 Engineer Brigade  
   CDF, **6-26, 5-6**  
   National, 5-4, 6-25, **6-26**  
 Engineer Company  
   Abn Inf Bde, 5-7, **5-25**  
   Inf Bde (Sep and Div), **3-33, 3-43, 3-46**  
   Inf Div, 1-3, **3-33**  
   MD, 1-3, **3-33, 4-33**  
   Mech Inf Bde (Sep and Div), 4-3, 4-8, **4-33**  
   Mech Inf Div, 2-9, **4-33**  
   MRL Bde, 6-11, **6-12**  
   Mtzd Inf Bde (Sep and Div), 3-3, 3-6, **3-33**  
   Mtzd Inf Div, 1-5, **3-33**  
   SSM Bde (SCUD), 6-23, **6-24**  
   SSM Bde (SS-21), 6-21, **6-22**  
   Tank Bde, 4-36, **4-42, 4-44**  
 Engineer Equipment Substitution Matrices, **B-1**  
 Engineer Platoon  
   Abn Inf Bn, 5-10, **5-18**  
   Commando Bn, 7-6, **7-17**  
   Separate Tank Bn, 1-7, **1-8**  
 Engineer Reconnaissance Platoon  
   Engr Bn, **2-30**  
   Water Crossing Regt, 6-41, **6-42**  
 Engineer Troops, National, 6-3, **6-25**  
 Equipment, xii  
   Baseline, xiii  
   Substitution, xiii  
 Expeditionary Army, viii, xi, 1-5, 2-9, 5-3, **5-5, 6-3**

—F—

Field Hospital, 5-3, 6-53  
 Fighter-Bomber Aviation Regiment, Air Force, 8-2, **8-3**  
 Fighter-Interceptor Aviation Regiment, Air Force,  
   8-2, **8-4**  
 Fire Control Battery, AA Gun Regt (57-mm),  
   1-24, **1-27**  
 Firing Battery  
   122-mm MRL Bn, 1-19, **1-20**  
   FROG Bn, 6-19, **6-20**

Firing Platoon  
122-mm Howitzer Btry, **1-16, 5-22**  
122-mm MRL Btry, **1-20**  
122-mm SP Howitzer Btry, **2-15**  
140-mm MRL Btry, **3-50**  
152-mm Gun-Howitzer Btry, **1-18**  
152-mm SP Howitzer Btry, 2-16, **2-17**  
Antitank Gun Btry, **1-32, 4-28**  
ATGM Btry, **1-33, 3-27**  
Frigate Squadron, Navy, **7-21**  
FROG Battalion  
FROG Bde, 6-17, **6-19**  
Separate, 5-3, **6-19**  
FROG Brigade, National, 5-3, 6-4, **6-17**  
FROG Firing Battery, FROG Bn, **6-20**  
FROG Regiment, National, 6-17

## —G—

General Staff, **7-2**  
Ground-Attack Aviation Regiment, Air Force, 8-2, **8-3**  
Ground Forces, **vii, 5-2, 7-2**  
Ground Forces Headquarters, **7-2**  
Gun Battalion (152-mm Self-Propelled), Arty Bde,  
6-5, **6-10**  
Gun-Howitzer Battalion (152-mm)  
Arty Bde, **1-17, 6-5**  
Arty Regt, 1-11, **1-17**  
Gun-Howitzer Battery (152-mm),  
152-mm Gun-Howitzer Bn, 1-17, **1-18**

## —H—

Headquarters and Control Battery  
Arty Bde, **1-14, 2-13, 6-5**  
Arty Regt, 1-11, **1-14, 6-11**  
MRL Bde, **1-14**  
SP Arty Regt, 2-10, **2-13**  
Headquarters and Control Platoon, MRL Bn,  
1-19, **1-20, 6-14**  
Headquarters and Service Company  
Recon & EC Bn, 1-35, **1-37, 2-27, 7-24**  
Water Crossing Regt, 6-41, **6-42**  
Headquarters and Service Platoon, Tank Bn, Tank Bde,  
4-39, **4-40, 4-47**  
Heavy Artillery Battalion, National, 5-3, 6-4, **6-15**  
Heavy Artillery Battery, Hvy Arty Bn, **6-15**  
Heavy Machinegun Platoon, Wpns Co, Commando Bn,  
7-14, **7-15**  
Hospital, 6-53  
Howitzer Battalion (122-mm)  
Arty Regt, 1-11, **1-15**  
Inf Bde (Sep), **1-15, 3-43**  
Mtzd Inf Bde (Sep), **1-15**

Howitzer Battalion (122-mm Self-Propelled)  
Mech Inf Bde (Sep and Div), **2-14, 4-3, 4-8**  
SP Arty Regt, 2-10, **2-14**  
Tank Bde, **2-14, 4-36, 4-44**  
Howitzer Battalion (152-mm Self-Propelled),  
SP Arty Regt, 2-10, **2-16**  
Howitzer Battery (122-mm)  
122-mm Howitzer Bn, 1-15, **1-16**  
Composite Arty Bn, Abn Inf Bde, 5-21, **5-22**  
Howitzer Battery (122-mm Self-Propelled),  
122-mm SP Howitzer Bn, 2-14, **2-15**

## —I—

Infantry, x, **3-1**  
Infantry-Based OPFOR, v, vi, **vii, x**  
Large, **vii**  
Small-to-Medium, **vii**  
Infantry Battalion  
Inf Bde (Sep, Div, and Militia), 3-43, 3-46, **3-49, 3-54,**  
5-6  
MD (Militia only), 1-3, **3-49**  
Infantry Battalion (Militia), 1-3, 1-4, **3-49, 5-6**  
Infantry Brigade (Divisional), 2-3, **3-46**  
Infantry Brigade (Militia), 1-3, 1-4, **3-54, 5-6**  
Infantry Brigade (Separate), 1-3, 1-4, **3-43**  
Infantry Company  
Inf Bn, **3-11, 3-49**  
Mtzd Inf Bn, 3-9, **3-11**  
Infantry Division, 1-3, **2-3. See also** Mechanized Infantry  
Division or Motorized Infantry Division  
Infantry Platoon, Inf Co,  
3-11, **3-12**  
Infantry Squad, Inf Plt,  
3-12, **3-13**  
Internal Security Forces, vi, x, 7-2, **7-25**

## —J—

Jamming Company, Recon & EC Bn,  
1-35, **1-41, 2-27, 7-24**

## —L—

Light Armored Vehicle Substitution Matrix, **A-3**  
Light Infantry, x  
Logistics Troops, National, 6-3, **6-53. See also**  
Maintenance, Materiel Support, or Supply and Service.  
Long-Range Reconnaissance Company,  
Recon & EC Bn, 1-35, **1-39, 2-27, 7-24**  
Long-Range Reconnaissance Platoon,  
Long-Range Recon Co, **1-39**



—M—

Machinegun Squad, Hvy MG Plt, **7-15**

Maintenance Battalion

Army, **1-48, 2-42, 5-5**

CDF, **1-48, 2-42, 5-6**

Inf Div, **2-3, 2-7**

Maint Bde, **1-48, 2-42, 6-54**

MD, **1-3, 1-48, 2-7, 2-42**

Mech Inf Div, **2-9, 2-42**

MR, **1-48, 2-42, 5-3**

Mtzd Inf Div, **1-5, 1-48**

National, **1-48, 2-42, 5-3, 6-53, 6-54**

Maintenance Brigade

MR, **5-3, 6-54**

National, **6-53, 6-54**

Maintenance Company

Abn Inf Bde, **5-7, 5-28**

Air Defense Regt, **2-19, 8-31**

Arty Bde, **1-23, 6-5**

Arty Regt, **1-11, 1-23**

MD, **1-3, 3-37, 4-35**

Mech Inf Bde (Sep and Div), **4-3, 4-8, 4-35**

MRL Bde, **1-23, 6-11**

Mtzd Inf Bde (Sep and Div), **3-3, 3-6, 3-37**

SAM Bde (SA-11), **8-20**

SAM Bde (SA-2), **8-10, 8-11**

SAM Bde (SA-3), **8-13, 8-14**

SAM Bde (SA-4), **8-16**

SAM Regt (SA-6 and SA-8), **8-24, 8-31, 8-32**

SP Arty Regt, **1-23, 2-10**

Tank Bde, **4-35, 4-36, 4-44**

Maintenance Platoon

Engr Bn, **2-30**

Inf Bde (Sep and Div), **3-43, 3-46, 3-53**

Mat Spt Bn, **1-44, 1-47, 2-41**

Obstacle Clearing Bn, **6-38, 6-39**

Pontoon Bridge Bn, **6-43, 6-44**

Road & Bridge Bn, **6-30, 6-31**

Maintenance Section, Separate Tank Bn,

**1-7, 1-9**

Maneuver Units, **x**

Materiel Support Battalion

Army, **1-44, 2-41, 5-5**

CDF, **2-41, 5-6**

Inf Div, **1-44, 2-3**

Mat Spt Bde, **6-54**

MD, **1-3, 1-44, 2-41**

Mech Inf Div, **2-9, 2-41**

Mtzd Inf Div, **1-5, 1-44**

National, **1-44, 2-41, 6-53**

Materiel Support Brigade

MR, **5-3, 6-54**

National, **6-53, 6-54**

Materiel Support Company

Abn Inf Bde, **5-7, 5-27**

Air Defense Regt, **2-19, 2-25**

Arty Bde, **1-23, 6-5**

Arty Regt, **1-11, 1-23**

Inf Bde (Sep and Div), **3-43, 3-46, 3-52**

Mech Inf Bde (Sep and Div), **3-36, 4-3, 4-8**

MRL Bde, **1-23, 6-11**

Mtzd Inf Bde (Sep and Div), **3-3, 3-6, 3-36**

SAM Bde (SA-11), **8-20**

SAM Bde (SA-2), **8-10, 8-11**

SAM Bde (SA-3), **8-13, 8-14**

SAM Bde (SA-4), **8-16**

SAM Regt (SA-6 and SA-8), **8-24, 8-30, 8-32**

SP Arty Regt, **1-23, 2-10**

Tank Bde, **4-36, 4-43, 4-44**

Materiel Support Platoon

122-mm MRL Bn, **1-19, 1-21**

Abn Inf Bn, **5-10, 5-19**

Antitank Bn, **1-30, 1-34, 4-26**

Antitank Gun Bn, **1-31, 1-34**

ATGM Bn, **1-34, 2-26**

MD. *See* Military District.

Mech. *See* Mechanized.

Mechanized Infantry, **xi**

Mechanized Infantry Battalion (APC)

Mech Inf Bde (Sep and Div), **4-3, 4-8, 4-13, 4-14**

Mtzd Inf Bde (Sep), **3-3**

Mechanized Infantry Battalion (IFV)

Mech Inf Bde (Sep and Div), **4-3, 4-8, 4-13, 4-14**

Mtzd Inf Bde (Sep), **3-3, 3-6**

Tank Bde, **4-13, 4-14, 4-36, 4-44**

Mechanized Infantry Brigade (Divisional), **xi, 2-9, 4-8,**

**4-9, 4-11**

Mechanized Infantry Brigade (Separate), **xi, 1-3, 1-4, 4-3,**

**4-4, 4-6, 5-5, 5-6**

Mechanized Infantry Company, Mech Inf Bn, **4-13, 4-16**

Mechanized Infantry Division, **xi, 1-3, 2-9, 5-5**

Mechanized Infantry Platoon, Mech Inf Co, **4-16, 4-17**

Mechanized Infantry Squad, Mech Inf Plt, **4-17, 4-18**

Medical Battalion

Army, **2-44, 5-5**

CDF, **2-44, 5-6**

Inf Div, **2-3, 2-44**

MD, **1-3, 2-44**

Mech Inf Div, **2-9, 2-44**

Mtzd Inf Div, **1-5, 2-44**

Medical Company

Inf Div, **1-52, 2-3**

MD, **1-3, 1-52**

Mech Inf Div, **1-52, 2-9**

Med Bn, **2-44, 2-45**

Mtzd Inf Div, **1-5, 1-52**

Medical Platoon  
   Abn Inf Bde, 5-7, **5-28**  
   Arty Bde, **3-42**, 6-5  
   Arty Regt, 1-11, **3-42**  
   Engr Bde, **3-42**, 6-26  
   Inf Bde (Sep and Div), **3-42**, 3-43, 3-46  
   Mech Inf Bde (Sep and Div), **3-42**, 4-3, 4-8  
   MRL Bde, **3-42**, 6-11  
   Mtzd Inf Bde (Sep and Div), 3-3, 3-6, **3-42**  
   SP Arty Regt, 2-10, **3-42**  
   Tank Bde, **3-42**, 4-36, 4-44  
 Medical Section  
   Abn Inf Bn, 5-10, **5-20**  
   Separate Tank Bn, 1-7, **1-10**  
 Medium Tank Substitution Matrix, **A-2**  
 Military District, viii, xi, **1-3**, 5-2, 5-3  
 Military Region, viii, 5-2, **5-3**, 6-3  
 Militia. *See* Infantry Battalion (Militia) and Infantry  
   Brigade (Militia).  
 Minesweeper Squadron, Navy, **7-21**  
 Missile Attack Boat Squadron, Navy, **7-21**  
 Missile Firing Battery  
   SAM Bn (SA-11), 8-22, **8-23**  
   SAM Bn (SA-4), 8-18, **8-19**  
   SAM Bn (SA-8), Air Defense Regt, **8-29**  
   SAM Regt (SA-6), 8-32, **8-35**  
   SAM Regt (SA-8), 8-24, **8-29**  
 Missile Technical Battery  
   SAM Regt (SA-6), **8-34**, 8-32  
   SAM Regt (SA-8), 8-24, **8-28**  
 Missile Technical Platoon, SAM Bn (SA-8), 2-21, **2-22**  
 Missile Troops and Artillery, National, 6-3, **6-4**  
 Mobile Field Bakery, Mat Spt Bn, 1-44, **1-47**, 2-41  
 Mortar Battalion  
   Inf Bde (Div), **3-23**  
   Mtzd Inf Bde (Div), 3-6, **3-23**, 3-46  
 Mortar Battery  
   Abn Inf Bn, 5-10, **5-14**  
   Composite Arty Bn, **5-14**, 5-21  
   Inf Bde, (Sep and Militia), **3-24**, 3-43, 3-54  
   Inf Bn 3-17, **3-24**, 3-49  
   Mech Inf Bde (Sep), **3-24**, 4-3  
   Mech Inf Bn, **3-24**, 4-13  
   Mortar Bn, 3-23, **3-24**  
   Mtzd Inf Bn, 3-10, 3-17, **3-24**  
   Mtzd Inf Bde (Sep), 3-3, **3-24**  
   Wpns Co, Inf Bn, 3-16  
   Wpns Co, Mtzd Inf Bn, 3-16  
 Mortar Platoon  
   Arty Btry, Commando Bn, **7-11**, 7-12  
   Commando Bn, 7-6, **7-11**  
   Commando Co, **3-15**, 7-8  
   Inf Co, 3-11, **3-15**  
   Mortar Btry, Abn Inf Bn, 5-14  
   Mortar Btry, Composite Arty Bn, 5-14  
   Mortar Btry, Inf Bde (Sep and Militia), 3-24, **3-25**  
   Mortar Btry, Mech Inf Bde (Sep), 3-24, **3-25**  
   Mortar Btry, Mech Inf Bn, 3-24, **3-25**  
   Mortar Btry, Mortar Bn, 3-24, **3-25**  
   Mortar Btry, Mtzd Inf Bde (Sep), 3-24, **3-25**  
   Wpns Co, Inf Bn, 3-16, **3-17**  
   Wpns Co, Mtzd Inf Bn, 3-16, **3-17**  
 Mortar Substitution Matrix, **A-4**  
 Motorcycle Platoon,  
   Recon Co, Inf Bde (Sep), 3-30, **3-31**, 4-29  
   Recon Co, Inf Div, 3-30, **3-31**  
   Recon Co, MD, 3-30, **3-31**  
   Recon Co, Mech Inf Bde (APC) (Sep), **3-31**, 4-29  
   Recon Co, Mtzd Inf Bde (Sep), 3-30, **3-31**, 4-29  
   Recon Co, Mtzd Inf Div, 3-30, **3-31**  
 Motorcycle Section  
   Motorcycle Plt, Recon Co, 3-31, **3-32**  
   Recon Co, Mech Inf Bde (IFV) (Sep), **3-32**, 4-31  
   Recon Co, Tank Bde, **3-32**, 4-31  
   Recon Plt, Inf Bde (Div and Militia), 3-29, **3-32**  
   Recon Plt, Mtzd Inf Bde (Div), 3-29, **3-32**  
   Signal Plt, Commando Bn, **3-32**, 7-18  
 Motorized Infantry, **x**, **3-1**  
 Motorized Infantry Battalion, Mtzd Inf Bde (Sep and Div),  
   **x**, 3-3, 3-6, **3-9**  
 Motorized Infantry Brigade (Divisional), **x**, 1-5, **3-6**  
 Motorized Infantry Brigade (Separate), **x**, xi, 1-3, 1-4, **3-3**,  
   5-5  
 Motorized Infantry Division, xi, 1-3, **1-5**, 5-5  
 Motor Transport Battalion, Mtzd Inf Bde (Sep and Div),  
   3-3, 3-6, 3-10, **3-38**  
 Motor Transport Section  
   Recon Co, Inf Bde (Sep and Militia), 3-30, **3-32**  
   Recon Co, Inf Div, 3-30, **3-32**  
   Recon Co, MD, 3-30, **3-32**  
   Recon Co, Mtzd Inf Bde (Sep), 3-30, **3-32**  
   Recon Co, Mtzd Inf Div, 3-30, **3-32**  
 MR. *See* Military Region  
 MRL. *See* Multiple Rocket Launcher.  
 Mtzd. *See* Motorized.  
 Multiple Rocket Launcher Battalion (122-mm)  
   Arty Regt, 1-11, **1-19**  
   MRL Bde, **1-19**, 6-11  
   SP Arty Regt, **1-19**, 2-10  
 Multiple Rocket Launcher Battalion (220-mm), MRL Bde,  
   6-11, **6-14**  
 Multiple Rocket Launcher Battery  
   Composite Arty Bn, Airborne Inf Bde, **3-50**, 5-21  
   Inf Bde (Sep and Div), 3-43, 3-46, **3-50**  
 Multiple Rocket Launcher Brigade, National, 6-4, **6-11**

—N—

National, xi. *See* National Asset Pool, Ground Forces).  
 National Asset Pool, Ground Forces, xi, 5-2, 5-3, **6-3**

National Headquarters, **7-2**  
Navy, vii, **7-2**, **7-21**  
Nonnation Forces, vi, ix

—O—

Obstacle Battalion, Engr Bde, 6-26, **6-35**  
Obstacle Clearing Battalion, Engr Bde, 6-26, **6-38**  
Obstacle Clearing Company, Obstacle Clearing Bn,  
6-38, **6-40**  
Obstacle Company, Obstacle Bn, **6-37**  
Operational, **5-1**  
Operations Battalion, DMI, **7-22**  
OPFOR. *See* Opposing Force  
Opposing Force, v  
Armor- and Mechanized-Based, , v, vi, **viii**, x  
Capabilities-Based, v  
Country-Based, v  
Infantry-Based, v, vi, **vii**, x  
In Peace and Conflict, **ix**  
Ordnance Maintenance Company, Maint Bn,  
1-48, **1-50**, 2-7, 2-42

—P—

Patrol Torpedo Boat Squadron, Navy, **7-21**  
Platoon Headquarters  
Abn Inf Plt, **5-12**  
Commando Plt, **7-9**  
Inf Plt, **3-12**  
Mech Inf. Plt, **4-17**  
Recon Plt (Tracked), **4-32**  
Tank Plt, **4-41**, **4-48**  
POL Transport Company, Mat Spt Bn, 1-44, **1-46**, 2-41  
Pontoon Bridge Battalion  
Engr Bde, 6-26, **6-43**  
Water Crossing Regt, 6-41, **6-43**  
Pontoon Bridge Company  
Engr Bn, 2-30, **2-36**  
Pontoon Bridge Bn, **2-36**, 6-43

—R—

Radio Company, Signal Bn, 2-37, **2-38**  
Radio Substitution, **C-3**  
Radio Telephone and Telegraph Company, Signal Bn,  
2-37, **2-39**  
Reconnaissance. *See also* Reconnaissance and Electronic  
Combat.  
Reconnaissance Aviation Regiment, Air Force, 8-2, **8-5**  
Reconnaissance and Electronic Combat Battalion  
Army, **1-35**, **2-27**, 5-5  
CDF, **2-27**, 5-6  
DMI, 1-3, 1-35, 1-36, 2-27, 2-28, 5-3, 7-22, 7-23, **7-24**

Inf Div, **1-35**, 2-3  
MD, 1-3, **1-35**, **2-27**  
Mech Inf Div, 2-9, **2-27**  
Mtzd Inf Div, 1-5, **1-35**  
Reconnaissance Company  
Abn Inf Bde, 5-7, **5-24**  
Inf Bde (Sep), **3-30**, 3-43, **4-29**  
Inf Div, 2-3, **3-30**  
MD, **3-30**  
Mech Inf Bde (APC) (Sep), 4-3, **4-29**  
Mech Inf Bde (IFV) (Sep), 4-3, **4-31**  
Mtzd Inf Bde (Sep), 3-3, **3-30**, **4-29**  
Mtzd Inf Div, 1-5, **3-30**  
Recon & EC Bn, Army, 1-35, **1-38**, 2-27, **2-29**  
Recon & EC Bn, CDF, 2-27, **2-29**  
Recon & EC Bn, DMI, **1-38**, **2-29** 7-24  
Recon & EC Bn, Inf Div, 1-35, **1-38**  
Recon & EC Bn, MD, 1-35, **1-38**, 2-27, **2-29**  
Recon & EC Bn, Mech Inf Div, 2-27, **2-29**  
Recon & EC Bn, Mtzd Inf Div, 1-35, **1-38**  
Tank Bde, **4-31**, 4-36, 4-44  
Reconnaissance Platoon. *See also* Reconnaissance Platoon  
(Tracked) or Reconnaissance Platoon (Wheeled).  
Inf Bde (Div and Militia), **3-29**, 3-46, 3-54, **4-30**  
Mtzd Inf Bde (Div), 3-6, **3-29**  
Recon Co, Inf Bde (Sep), 3-30, **3-31**  
Recon Co, Inf Div, 3-30, **3-31**  
Recon Co, MD, 3-30, **3-31**  
Recon Co, Mtzd Inf Bde (Sep), 3-30, **3-31**  
Recon Co, Mtzd Inf Div, 3-30, **3-31**  
Reconnaissance Platoon (Tracked)  
Mech Inf Bde (IFV) (Div), 2-29, 4-8, **4-32**  
Recon Co, Mech Inf Bde (IFV) (Sep), 2-29, 4-31, **4-32**  
Recon Co, Tank Bde, 2-29, 4-31, **4-32**  
Recon Co, Recon & EC Bn, Army, 2-29, **4-32**  
Recon Co, Recon & EC Bn, CDF, 2-29, **4-32**  
Recon Co, Recon & EC Bn, DMI, 2-29, **4-32**  
Recon Co, Recon & EC Bn, MD, 2-29, **4-32**  
Recon Co, Recon & EC Bn, Mech Inf Div, 2-29, **4-32**  
Reconnaissance Platoon (Wheeled)  
Inf Bde (Div), 4-29, **4-30**  
Mech Inf Bde (Div), 4-8, 4-29, **4-30**  
Mtzd Inf Bde (Div), 3-6, 4-29, **4-30**  
Recon Co, Inf Bde (Sep), 4-29, **4-30**  
Recon Co, Mech Inf Bde (APC) (Sep), 4-29, **4-30**  
Recon Co, Mech Inf Bde (IFV) (Sep), **4-30**, 4-31  
Recon Co, Mtzd Inf Bde (Sep), 4-29, **4-30**  
Recon Co, Tank Bde, 4-29, **4-30**  
Recovery Platoon  
Maint Bn, Army, 2-42, **2-43**  
Maint Bn, CDF, 2-42, **2-43**  
Maint Bn, MD, 2-42, **2-43**  
Maint Bn, Mech Inf Div, 2-42, **2-43**  
Maint Bn, National, 2-42, **2-43**

Regiment, **xi, 3-1, 4-1**  
 Regimental Headquarters  
   Air Defense Regt, 2-19, **8-26**  
   AA Gun Regt (57-mm), 1-24, **1-26**  
   SAM Regt (SA-6 and SA-8), 8-24, **8-26, 8-32**  
 Region Depot, 1-3, 5-3  
 Remotely-Piloted Vehicle. *See* RPV.  
 Road and Bridge Battalion, Engr Bde, 6-26, **6-30**  
 Road and Bridge Construction Company, Engr Bn,  
   2-30, **2-35**  
 Road Construction Company, Road and Bridge Bn,  
   6-30, **6-34**  
 Rocket Launcher Platoon, Arty Btry, Commando Bn,  
   7-12, **7-13**  
 Rocket Launcher Substitution Matrix, **A-7**  
 RPV Squadron, Recon & EC Bn, 1-35, **1-42, 2-27, 7-24**

—S—

SAM Battalion (SA-11), SAM Bde (SA-11), 8-20, **8-22**  
 SAM Battalion (SA-2), SAM Bde (SA-2), 8-10, **8-12**  
 SAM Battalion (SA-3), SAM Bde (SA-3), 8-13, **8-15**  
 SAM Battalion (SA-4), SAM Bde (SA-4), 8-16, **8-18**  
 SAM Battalion (SA-8), Air Defense Regt, 2-19, **2-21**  
 SAM Brigade (SA-11), ADC, 5-3, 8-9, **8-20**  
 SAM Brigade (SA-2), ADC, 5-3, 8-9, **8-10**  
 SAM Brigade (SA-3), ADC, 5-3, 8-9, **8-13**  
 SAM Brigade (SA-4), ADC, 5-3, 8-9, **8-16**  
 SAM Platoon  
   Abn Inf Bn, 5-7, 5-10, **5-15**  
   Mech Inf Bn, 4-13, **4-19**  
   SAM Bn (SA-11), **4-19, 8-22**  
   Wpns Co, Commando Bn, **5-15, 7-14**  
   Wpns Co, Inf Bn, 3-16, **3-18**  
   Wpns Co, Mtd Inf Bn, 3-16, **3-18**  
 SAM Regiment (SA-6), ADC, 5-3, 8-9, **8-32**  
 SAM Regiment (SA-8), ADC, 5-3, 8-9, **8-24**  
 SAM Squad  
   AA Gun Bn (Mixed), 2-4, **2-23**  
   AA Gun Bn (57-mm), **2-23, 2-24**  
   AA Gun Btry (57-mm), 1-28, **2-23**  
   Missile Firing Btry (SA-6 and SA-8), **2-23, 8-29, 8-35**  
   Missile Technical Battery, SAM Regt (SA-6 and SA-8),  
     **2-23, 8-28, 8-34**  
   Missile Technical Platoon, SAM Bn (SA-8), 2-22, **2-23**  
   SAM Bn (SA-2), **2-23, 8-12**  
   SAM Bn (SA-3), **2-23, 8-15**  
   SAM Bn (SA-8), 2-21, **2-23**  
 SAM Substitution Matrix, **A-12**  
 Self-Propelled Antiaircraft Gun Battery (23-mm)  
   Mech Inf Bde (Sep and Div), 4-3, 4-8, **4-25**  
   SP Arty Regt, 2-10, **4-25**  
   Tank Bde, **4-25, 4-36, 4-44**

Self-Propelled Artillery Substitution Matrix, **A-6**  
 Self-Propelled Artillery Regiment  
   Army, **2-10, 5-5**  
   CDF, **2-10, 5-6**  
   MD, 1-3, **2-10**  
   Mech Inf Div, 2-9, **2-10**  
   National, **2-10, 5-3, 6-4**  
 Self-Propelled Gun Battalion (152-mm), Arty Bde,  
   6-5, **6-10**  
 Self-Propelled Howitzer Battalion (122-mm)  
   Mech Inf Bde (Sep and Div), **2-14, 4-3, 4-8**  
   SP Arty Regt, 2-10, **2-14**  
   Tank Bde, **2-14, 4-36, 4-44**  
 Self-Propelled Howitzer Battalion (152-mm),  
   SP Arty Regt, 2-10, **2-16**  
 Self-Propelled Howitzer Battery (122-mm),  
   122-mm SP Howitzer Bn, 2-14, **2-15**  
 Self-Propelled Howitzer Battery (152-mm),  
   152-mm SP Howitzer Bn, 2-16, **2-17**  
 Separate (Units), **xi**  
 Separate Brigade, **3-1, 4-1**. *See* Infantry Brigade (Separate),  
   Mechanized Infantry Brigade (Separate), or Motorized  
   Infantry Brigade (Separate).  
 Separate Heliborne Jamming Squadron, Air Force, 8-2,  
   **8-6**  
 Separate Helicopter Squadron, Air Force, 8-2, **8-7**  
 Separate Infantry Brigade. *See* Infantry Brigade (Separate),  
   Mechanized Infantry Brigade (Separate), or Motorized  
   Infantry Brigade (Separate).  
 Separate Tank Battalion, **xi**  
   Inf Div, **1-7, 2-3**  
   Mech Inf Bde (Sep and Div), **1-7, 4-3, 4-8**  
   Mech Inf Div, **1-7, 2-9**  
   Mtd Inf Div, 1-5, **1-7**  
 Service Battery  
   AA Gun Bn (57-mm), 2-24, **2-25**  
   AA Gun Regt (57-mm), 1-24, **1-29**  
 Service Platoon  
   Engr Bn, **2-30**  
   Obstacle Clearing Bn, 6-38, **6-39**  
   Pontoon Bridge Bn, 6-43, **6-44**  
   Road & Bridge Bn, 6-30, **6-31**  
 Signal Battalion  
   Army, **2-37, 5-5**  
   CDF, **2-37, 5-6**  
   Inf Div, 2-3, **2-37**  
   MD, 1-3, **2-37**  
   Mech Inf Div, 2-9, **2-37**  
   Mtd Inf Div, 1-5, **2-37**  
   National (Signal Bde ), **2-37, 5-3, 6-46, 6-47**  
   Signal Brigade, National, 6-46, **6-47**

Signal Company  
 Abn Inf Bde, 5-7, **5-26**  
 FROG Bde, 6-17, **6-18**  
 Inf Bde (Sep and Div), **3-34**, 3-43, 3-46  
 Inf Div, 2-3, **3-34**  
 MD, 1-3, **3-34**, **4-34**  
 Mech Inf Bde (Sep and Div), 4-3, 4-8, **4-34**  
 Mech Inf Div, 2-9, **4-34**  
 Mtzd Inf Bde (Sep and Div), 3-3, 3-6, **3-34**  
 Mtzd Inf Div, 1-5, **3-34**  
 SSM Bde (SCUD), 6-23, **6-24**  
 SSM Bde (SS-21), 6-21, **6-22**  
 Tank Bde, **4-34**, 4-36, 4-44

Signal Platoon  
 Abn Inf Bn, 5-10, **5-19**  
 Commando Bn, 7-6, **7-18**  
 Engr Bn, **2-30**  
 Mech Inf Bn, **3-21**, 4-13  
 Mtzd Inf Bn, 3-9, **3-21**  
 Obstacle Clearing Bn, 6-38, **6-39**  
 Pontoon Bridge Bn, 6-43, **6-44**  
 Road & Bridge Bn, 6-30, **6-31**

Signal Regiment, National, **6-46**  
 Signal Section, Separate Tank Bn, 1-7, **1-9**  
 Signals Reconnaissance Battalion, DMI, 5-3, 7-22, **7-23**  
 Signals Reconnaissance Company, Recon & EC Bn,  
 1-35, **1-40**, 2-27, 7-24

Signal Troops, National, 6-3, **6-46**  
 Smoke Battalion, National, 6-47, **6-52**  
 Smoke Company, Smoke Bn, **6-52**  
 Special Maintenance Platoon, Maint Bn, **1-51**, 2-7, 2-42  
 Special Operations Command, vii, 7-2, **7-3**  
 Special-Purpose Forces Battalion, SPF Bde, 7-3, **7-4**  
 Special-Purpose Forces Brigade, SOC, **7-3**  
 Special-Purpose Forces Company, SPF Bn, **7-4**  
 Special-Purpose Forces Team, SPF Co, 7-4, **7-5**  
 SSM Battalion (SCUD), **6-23**, **6-24**  
 SSM Battalion (SS-21), **6-21**, **6-22**  
 SSM Brigade (SCUD), National, 5-3, 6-4, **6-23**  
 SSM Brigade (SS-21), National, 5-3, 6-4, **6-21**  
 SSM Substitution Matrix, **A-8**

State, vii

Strategic, **5-1**

Strategic Reserve, **5-1**, 5-6

Submarine Chaser Squadron, Navy, **7-21**

Submarine Squadron, Navy, **7-21**

Supply and Service Company  
 Motor Transport Bn, 3-38, **3-41**  
 SAM Bn (SA-8), 2-21, **2-23**

Supply and Service Platoon  
 Chem Def Bn, 6-48, **6-51**  
 Commando Bn, 7-6, **7-19**  
 Inf Bde (Militia), 3-54, **3-56**  
 Maint Bn, Army, 1-48, **1-51**, 2-42, **2-43**  
 Maint Bn, CDF, 1-48, **1-51**, 2-42, **2-43**  
 Maint Bn, Inf Div, 2-7, **2-8**

Maint Bn, MD, 1-48, **1-51**, 2-7, 2-42, **2-43**  
 Maint Bn, Mech Inf Div, 2-42, **2-43**  
 Maint Bn, Mtzd Inf Div, 1-48, **1-51**  
 Maint Bn, National, 1-48, **1-51**, 2-42, **2-43**  
 Mat Spt Bn, 1-44, **1-47**, 2-41  
 Mech Inf Bn, 4-13, **4-24**  
 Med Bn, 2-44, **2-47**  
 Mtzd Inf Bn, 3-9, **3-22**  
 Signal Bn, 2-37, **2-39**

Support Platoon, Separate Tank Bn, 1-7, **1-10**  
 Supreme High Command Headquarters, **7-2**  
 Surface-to-Air Missile. *See* SAM.  
 Surface-to-Surface Missile. *See* SSM.

—T—

Tank Battalion (22-Tank Variant),  
 Tank Bde (67-Tank Variant), 4-39, 4-44, **4-47**

Tank Battalion (31-Tank Standard),  
 Tank Bde (94-Tank Standard), 4-36, **4-39**

Tank Brigade, xi, 1-3, 1-4  
 Tank Brigade (67-Tank Variant), **4-44**, 5-5, 5-6  
 Tank Brigade (94-Tank Standard), **4-36**, 5-5, 5-6  
 Tank Company (10-Tank Standard)  
 Separate Tank Bn, 1-7, **4-41**  
 Tank Bn (31-Tank Standard), 4-39, **4-41**

Tank Company (7-Tank Variant)  
 Separate Tank Bn, 1-7, **4-48**  
 Tank Bn (22-Tank Variant), 4-47, **4-48**

Tank-Launched Bridge Company, Road and Bridge Bn,  
 6-30, **6-33**

Tank Platoon, Tank Co, **4-41**, **4-48**  
 Tank Squad, Tank Plt, **4-41**, **4-48**  
 Tank Substitution Matrix, **A-2**  
 Tank Units, xi

Target Acquisition Battery  
 Arty Bde, **1-22**, **2-18**, 6-5  
 Arty Regt, 1-11, **1-22**  
 MRL Bde, **1-22**, 6-11  
 SP Arty Regt, 2-10, **2-18**

Target Acquisition/Early Warning Battery  
 Air Defense Regt, 2-19, **8-27**  
 SAM Bde (SA-11), **8-20**  
 SAM Bde (SA-2), 8-10, **8-11**  
 SAM Bde (SA-3), 8-13, **8-14**  
 SAM Bde (SA-4), **8-16**  
 SAM Regt (SA-6 and SA-8), 8-24, **8-27**, 8-32

Technical Support and Service Battery  
 FROG Bde, 6-17, **6-18**  
 SSM Bde (SCUD), 6-23, **6-24**  
 SSM Bde (SS-21), 6-21, **6-22**

Threat, v

Towed Artillery Substitution Matrix, **A-5**  
 Tracked Vehicle Maintenance Company, Maint Bn,  
 1-48, **1-49**, 2-7, 2-42

Trailer Substitution, **C-2**  
Transport Aviation Regiment, Air Force, 8-2, **8-8**  
Transport Helicopter Regiment, Air Force, 8-2, **8-6**  
Troop Transport Company, Motor Transport Bn,  
3-11, 3-12, 3-13, 3-14, 3-38, **3-39**  
Troop Transport Platoon, Commando Bn, 7-6, **7-20**  
Truck-Launched Bridge Company, Road and Bridge Bn,  
6-30, **6-32**  
Truck Substitution, **C-1**

—**W**—

Water Crossing Regiment, National, 6-25, **6-41**  
Weapons Company  
Commando Bn, 7-6, **7-14**  
Inf Bn, **3-16**, 3-49  
Mtzd Inf Bn, 3-9, **3-16**  
Weapons Squad  
Abn Inf Plt, **3-14**, 5-12  
Inf Plt, 3-12, **3-14**  
Weapons Transport Company, Motor Transport Bn,  
3-16, 3-17, 3-18, 3-19, 3-20, 3-38, 3-39, **3-40**  
Wheeled Vehicle Maintenance Company, Maint Bn,  
1-48, **1-50**, 2-7, 2-42

By Order of the Secretary of the Army:

Official:

  
JOEL B. HUDSON  
*Acting Administrative Assistant to the  
Secretary of the Army*  
01502

DENNIS J. REIMER  
*General, United States Army  
Chief of Staff*

**DISTRIBUTION:**

Active Army, USAR, and ARNG: To be distributed in accordance with DA Form 12-11E, requirements for FM 100-63, *Infantry-Based Opposing Force, Organization Guide* (Qty rqr block no. 5359)